

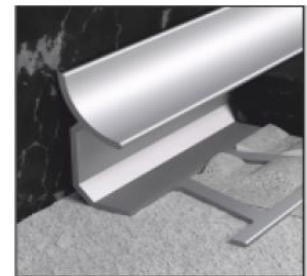

KAFES GROUP
Ostim Osb Mh. 1568 Cd. No:51
06105 Yenimahalle/ANKARA
TEL.:+90 (0) 535 248 97 85
WEB.: www.kafesgroup.com
Email.: info@kafesgroup.com

KAFES GROUP PROFİEL SYSTEMS

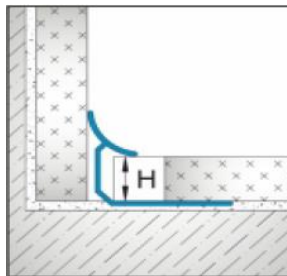

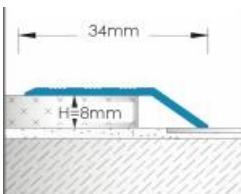
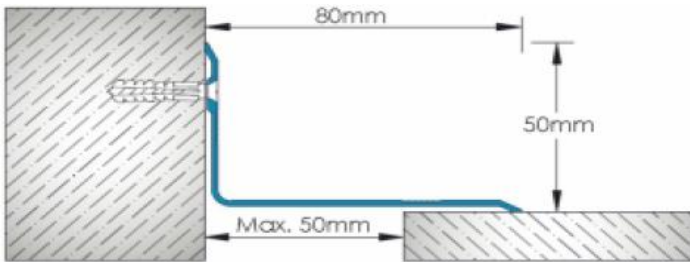
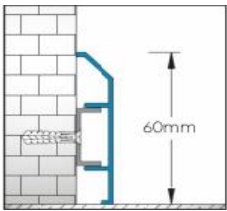
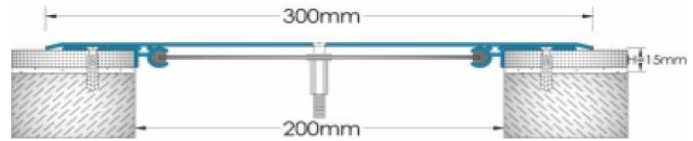
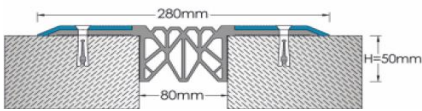
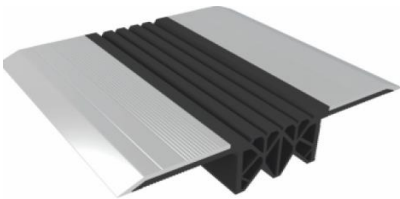
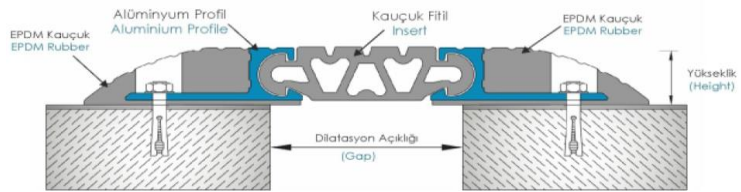
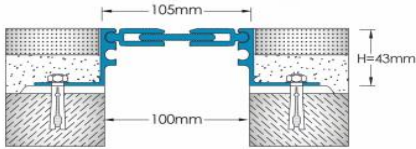
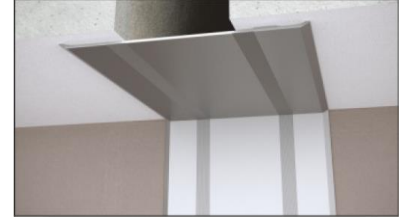
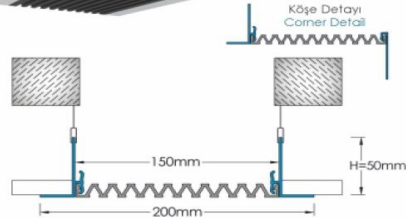
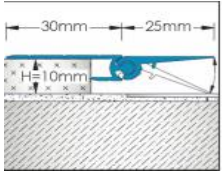

İÇİNDEKİLER / INDEX

3cm Açıklık İçin Duvar-Tavan Dilatasyon Profilleri Wall-Ceiling Expansion Joint Profiles For 3cm Gaps	6
3cm Açıklık İçin Zemin Dilatasyon Profilleri Floor Expansion Joint Profiles For 3cm Gaps	10
5cm Açıklık İçin Duvar-Tavan Dilatasyon Profilleri Wall-Ceiling Expansion Joint Profiles For 5cm Gaps	16
5cm Açıklık İçin Zemin Dilatasyon Profilleri Floor Expansion Joint Profiles For 3cm Gaps	21
8cm Açıklık İçin Duvar-Tavan Dilatasyon Profilleri Wall-Ceiling Expansion Joint Profiles For 8cm Gaps	31
8cm Açıklık İçin Zemin Dilatasyon Profilleri Floor Expansion Joint Profiles For 3cm Gaps	35
10cm Açıklık İçin Duvar-Tavan Dilatasyon Profilleri Wall-Ceiling Expansion Joint Profiles For 10cm Gaps	39
10cm Açıklık İçin Zemin Dilatasyon Profilleri Floor Expansion Joint Profiles For 3cm Gaps	44
12cm Açıklık İçin Duvar-Tavan Dilatasyon Profilleri Wall-Ceiling Expansion Joint Profiles For 12cm Gaps	52
12cm Açıklık İçin Zemin Dilatasyon Profilleri Floor Expansion Joint Profiles For 12cm Gaps	56
15cm Açıklık İçin Duvar-Tavan Dilatasyon Profilleri Wall-Ceiling Expansion Joint Profiles For 15cm Gaps	59
15cm Açıklık İçin Zemin Dilatasyon Profilleri Floor Expansion Joint Profiles For 3cm Gaps	63
20cm Açıklık İçin Duvar-Tavan Dilatasyon Profilleri Wall-Ceiling Expansion Joint Profiles For 20cm Gaps	67
20cm Açıklık İçin Zemin Dilatasyon Profilleri Floor Expansion Joint Profiles For 20cm Gaps	68



KAFES GROUP
Ostim Osb Mh. 1568 Cd. No:51
06374 Yenimahalle/Ankara/Turkey
Tel.:+90 (0) 535 248 97 85
WEB.: www.kafesgroup.com
EMAIL.: info@kafesgroup.com

KAFES GROUP PROFILE SYSTEMS

Su Yalıtımlı Dilatasyon Profilleri Wateright Expansion Joint Profiles	70
Kapak Dilatasyon Profilleri Cover Expansion Joint Profiles	71
Duvar & Tavan Dilatasyon Derz Fitilleri Wall & Ceiling Rubber Joint Profiles	74
Zemin Dilatasyon Derz Fitilleri Floor Rubber Joint Profiles	74
Çelik Dilatasyon Profilleri Steel Expansion Joint Profiles	76
Alüminyum Otopark Profilleri Aluminium Carpark Profiles	76
Kauçuk Otopark Zemin Profilleri Rubber Carpark Floor Profiles	77
Kasisli Otopark Dilatasyon Profilleri Carpark Profiles	78
Dilatasyon Yalıtım Bantları Rubber Insulating Tapes	79
Pah Bandı TPE based	79
Dilatasyonlu Harpuşta Profilleri Cooping Expansion Joint Profiles	80
Parapet Profilleri Parapet Profiles	80
Seramik Bitim ve Dış Köşe Profilleri Ceramic Ending & Exterior Tile Profiles	81
Seramik İç Köşe Profilleri Ceramic Interior Tile Profiles	83
Seramik Bitim ve İç Köşe Profilleri Edge Profiles For Ceramic	84
Köşe Koruma Profilleri Corner Guard Profiles	85



KAFES GROUP
Ostim Osb Mh. 1568 Cd. No:51
06374 Yenimahalle/Ankara/Turkey
Tel.:+90 (0) 535 248 97 85
WEB.: www.kafesgroup.com
EMAIL.: info@kafesgroup.com

KAFES GROUP PROFILE SYSTEMS

Paslanmaz Köşe Koruma Profilleri <i>Stainless Steel Corner Guard Profiles</i>	85
KüvetKenar Profili <i>Bathtub Profile</i>	85
Bordür Profilleri <i>Border Profiles</i>	86
Seramik Tesviye Sistemi <i>Ceramic Levelling System</i>	86
Derz Artıları <i>Tile Spaces</i>	86
Genleşme Derz Profilleri <i>Movement Joint Profiles</i>	87
AlüminyumSüpürgelik Profilleri <i>Aluminium Skirting Profiles</i>	88
Paslanmaz Çelik Süpürgelik Profilleri <i>Stainless Steel Skirting Profiles</i>	91
Eşik (Geçiş) Profilleri <i>Threshold Profiles</i>	92
Kot Farkı Profilleri <i>Level Difference Trim Profiles</i>	93
Parke ve Halı Bitim Profilleri <i>Parquet and Carpet Edge Trim Profiles</i>	94
Merdiven Burun Profilleri <i>Stair Nosing Profiles</i>	95
LED Işıklı Merdiven Burun Profilleri <i>LED Light Stair Nosing Profiles</i>	96
Kaydırmazlık Bantları <i>Anti-Slip Tape</i>	97
Hijyenik Paspas <i>Hygienic Doormat</i>	98
AlüminyumPaspas Sistemleri <i>Aluminium Doormat Systems</i>	99



KAFES GROUP
Ostim Osb Mh. 1568 Cd. No:51
06374 Yenimahalle/Ankara/Turkey
Tel.:+90 (0) 535 248 97 85
WEB.: www.kafesgroup.com
EMAIL.: info@kafesgroup.com

KAFES GROUP PROFILE SYSTEMS

Dış Mekan İnce Paspas Sistemleri Outdoor Slim Doormat Systems	100
İç Mekan İnce Paspas Sistemleri Indoor Slim Doormat Systems	102
Duvar Koruma Sistemleri Crash Rail Wall Guard Systems	104
180mm Elips Duvar Koruma Sistemi 180mm Ellipse Wall Guard Systems	105
El Tutamaklı Duvar Koruma Sistemi Wall Guard Systems With Handrail	106
Peimium Tutamaklı Duvar Koruma Sistemi Permium Wall Guard Systems With Handrail	107
Otopark Duvar ve Köşe Koruma Sistemi Car Park Wall and Corner Guard Systems	109
Alçıpan Fuga Profilleri Drywall Profiles	110
Yalıtım Baskı Profilleri Insulation Fixing Profiles	111
İzolasyon Askı Pimi (OPİM) Insulation Hanger Pins	111
Kaba Sıva Köşe Profilleri Rough Cast Corner Profiles	112
Alüminyum ve Galvaniz Köşe Profilleri Aluminium and Galvanized Corner Profiles	112
Fileli Alüminyum ve PVC Köşe Profilleri Aluminium and PVC Corner Profiles With Mesh	112
Fileli Alüminyum ve PVC Damlalık Profilleri Aluminium and PVC Dripstone Profiles With Mesh	112
Denizlik Uzatma Profilleri Windowsills Waterway Stretching Profiles	113
PVC ve Alüminyum Fuga Profilleri PVC and Aluminium Fuga Profiles	113



KAFES GROUP
Ostim Osb Mh. 1568 Cd. No:51
06374 Yenimahalle/Ankara/Turkey
Tel.:+90 (0) 535 248 97 85
WEB.: www.kafesgroup.com
EMAIL.: info@kafesgroup.com

KAFES GROUP PROFILE SYSTEMS

Aynalı Fuga Profili Fuga Profile With Mirror	113
Alüminyum Subasman (Başlangıç) Profilleri Aluminium Sub-Basement Profiles	113
Ayarlanabilir Açılı Köşe Profilleri Adjustable Plaster Corner Profiles	114
Alçıpan Bitim Profilleri Drywall Ending Profiles	114
Sıva Bitim Profili Plaster Ending Profiles	114
Alüminyum Mastar Profilleri Aluminium Plaster Rules Profiles	114
Sıva Dilatasyon Profili Plaster Expansion Joint Profiles	115
Fileli Dilatasyon Profili Expansion Joint Profiles With Mesh	115
Sıva Filesi Fiber Glass Mesh	115
Mantolama Dübelleri Insulation Plugs	115





KAFES GROUP
Ostim Osb Mh. 1568 Cd. No:51
06374 Yenimahalle/Ankara/Turkey
Tel.:+90 (0) 535 248 97 85
WEB.: www.kafesgroup.com
EMAIL.: info@kafesgroup.com

KAFES GROUP PROFILE SYSTEMS

3cm Açıklık İçin Duvar-Tavan Dilatasyon Profilleri Wall-Ceiling Expansion Joint Profiles For 3cm Gaps

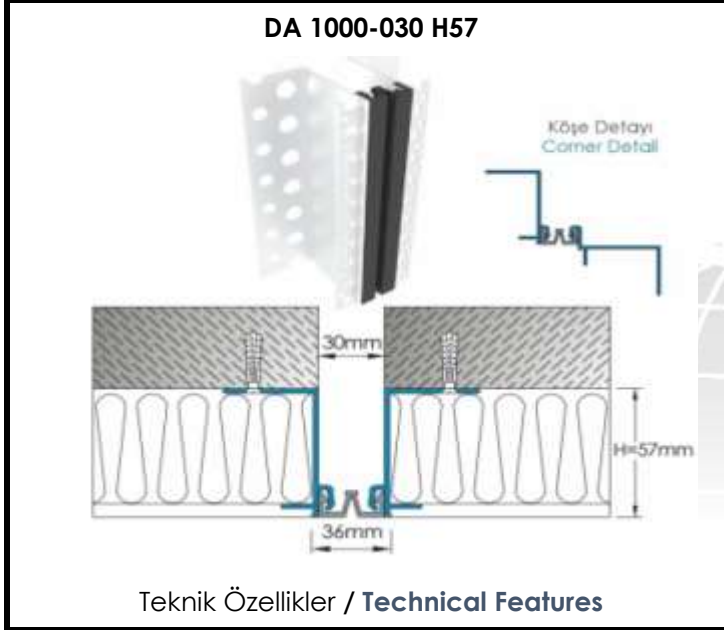

Dilatasyon Derz Açıklığı / Gap	30 mm
Yükseklik / Height	57 mm
Yüzey Genişliği / Surface Width	36 mm
Hareket Kapasitesi / Movement Capacity	± 10 mm

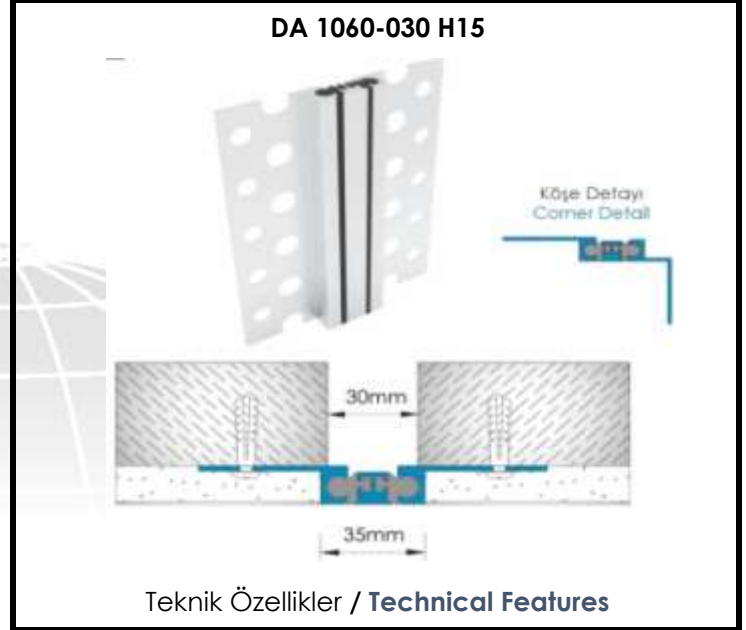

Dilatasyon Derz Açıklığı / Gap	30 mm
Yükseklik / Height	15 mm
Yüzey Genişliği / Surface Width	35 mm
Hareket Kapasitesi / Movement Capacity	± 5 mm

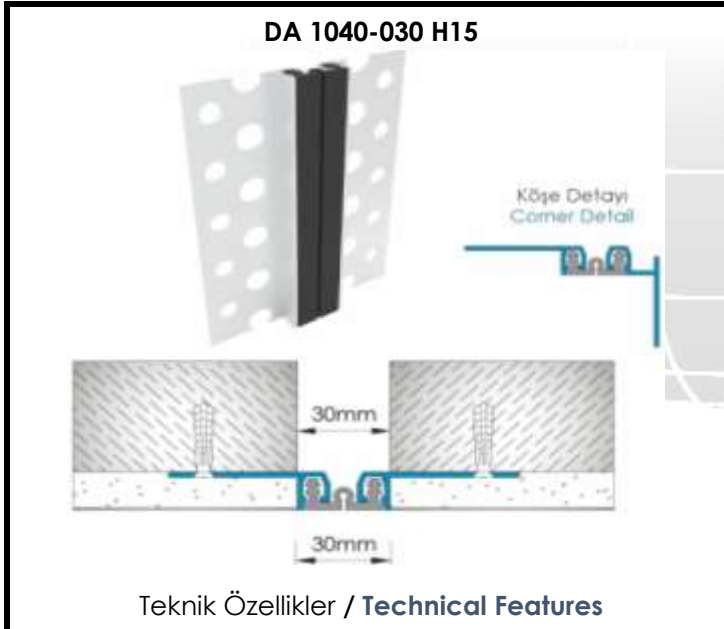

Dilatasyon Derz Açıklığı / Gap	30 mm
Yükseklik / Height	15 mm
Yüzey Genişliği / Surface Width	30 mm
Hareket Kapasitesi / Movement Capacity	± 10 mm

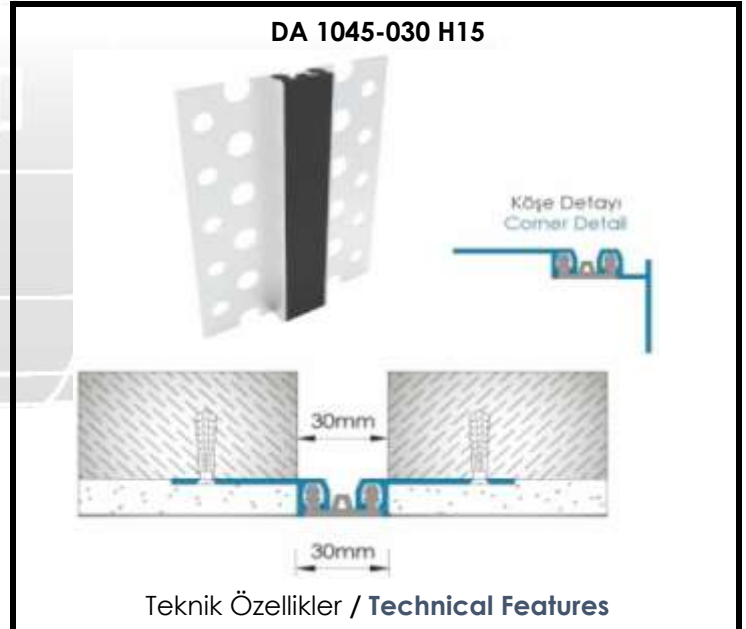

Dilatasyon Derz Açıklığı / Gap	30 mm
Yükseklik / Height	15 mm
Yüzey Genişliği / Surface Width	30 mm
Hareket Kapasitesi / Movement Capacity	± 5 mm



KAFES GROUP
Ostim Osb Mh. 1568 Cd. No:51
06374 Yenimahalle/Ankara/Turkey
Tel.:+90 (0) 535 248 97 85
WEB.: www.kafesgroup.com
EMAIL.: info@kafesgroup.com

KAFES GROUP PROFILE SYSTEMS

3cm Açıklık İçin Duvar-Tavan Dilatasyon Profilleri Wall-Ceiling Expansion Joint Profiles For 3cm Gaps

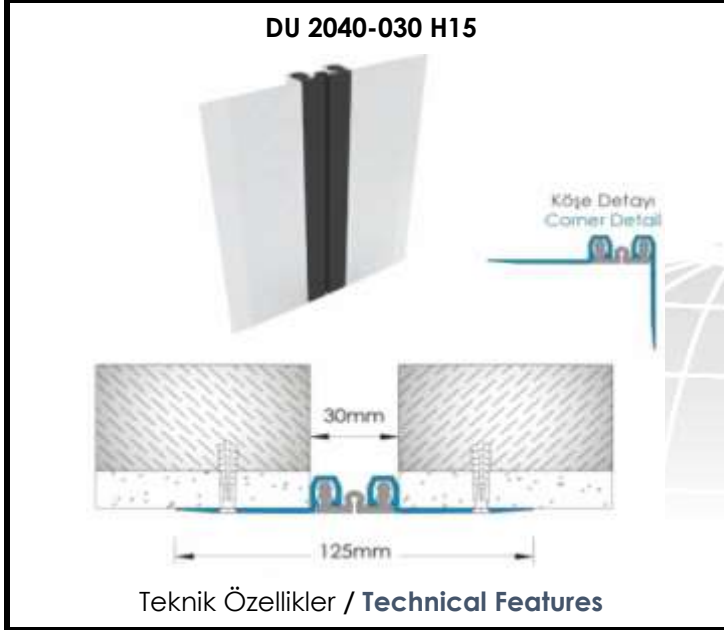

Dilatasyon Derz Açıklığı / Gap	30 mm
Yükseklik / Height	15 mm
Yüzey Genişliği / Surface Width	125 mm
Hareket Kapasitesi / Movement Capacity	± 10 mm

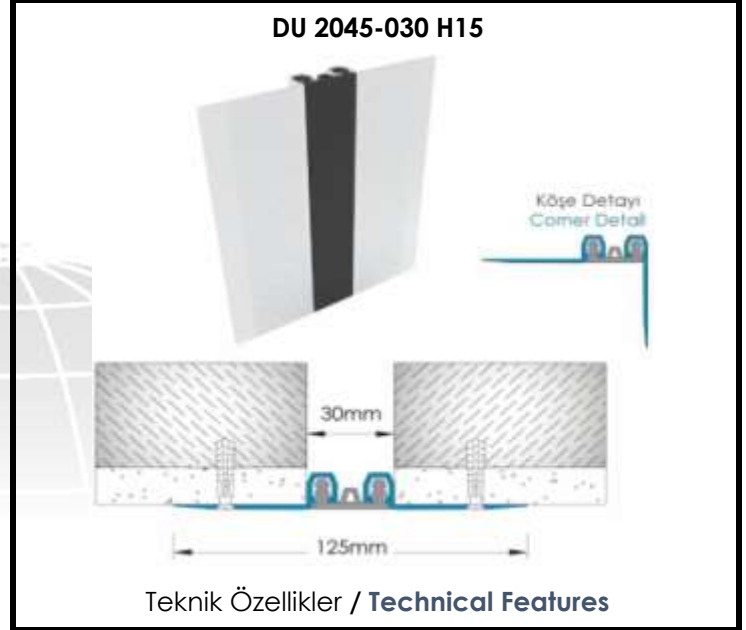

Dilatasyon Derz Açıklığı / Gap	30 mm
Yükseklik / Height	15 mm
Yüzey Genişliği / Surface Width	125 mm
Hareket Kapasitesi / Movement Capacity	± 5 mm

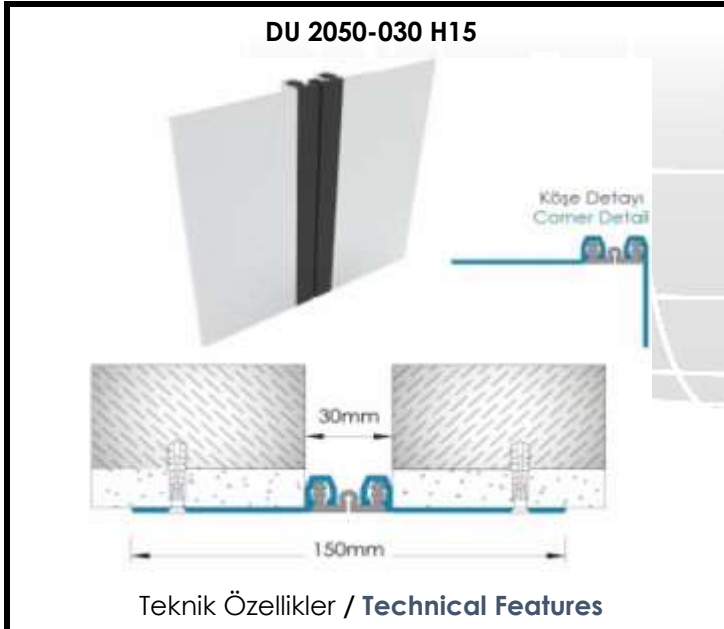

Dilatasyon Derz Açıklığı / Gap	30 mm
Yükseklik / Height	15 mm
Yüzey Genişliği / Surface Width	150 mm
Hareket Kapasitesi / Movement Capacity	± 10 mm

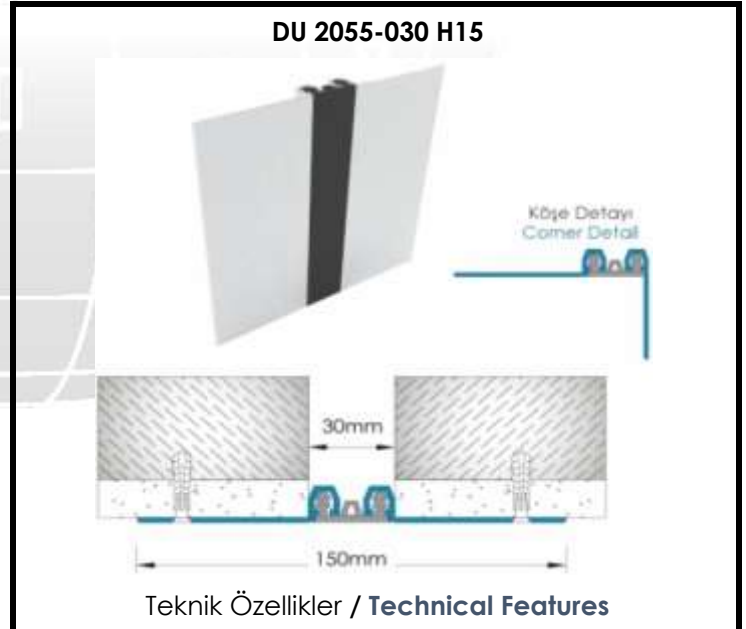

Dilatasyon Derz Açıklığı / Gap	30 mm
Yükseklik / Height	15 mm
Yüzey Genişliği / Surface Width	150 mm
Hareket Kapasitesi / Movement Capacity	± 5 mm



KAFES GROUP
Ostim Osb Mh. 1568 Cd. No:51
06374 Yenimahalle/Ankara/Turkey
Tel.:+90 (0) 535 248 97 85
WEB.: www.kafesgroup.com
EMAIL.: info@kafesgroup.com

KAFES GROUP PROFILE SYSTEMS

3cm Açıklık İçin Duvar-Tavan Dilatasyon Profilleri Wall-Ceiling Expansion Joint Profiles For 3cm Gaps

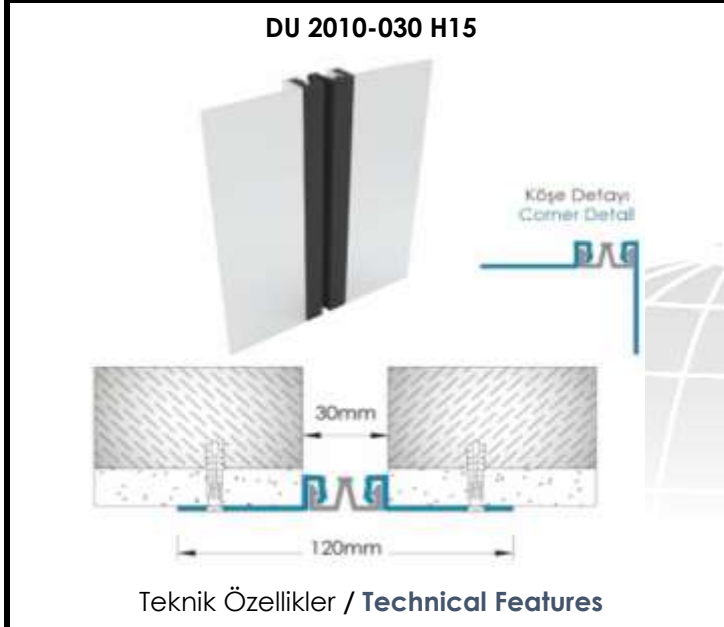

Dilatasyon Derz Açıklığı / Gap	30 mm
Yükseklik / Height	15 mm
Yüzey Genişliği / Surface Width	120 mm
Hareket Kapasitesi / Movement Capacity	± 10 mm

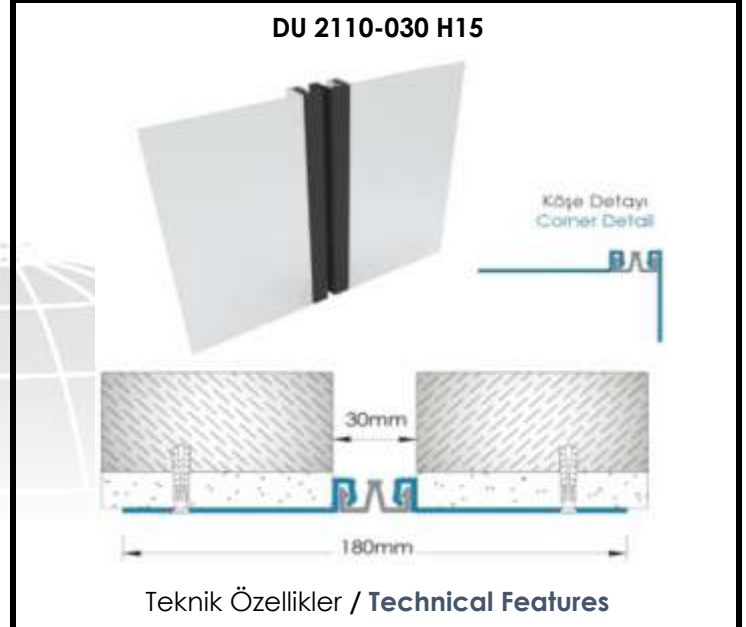

Dilatasyon Derz Açıklığı / Gap	30 mm
Yükseklik / Height	15 mm
Yüzey Genişliği / Surface Width	180 mm
Hareket Kapasitesi / Movement Capacity	± 5 mm

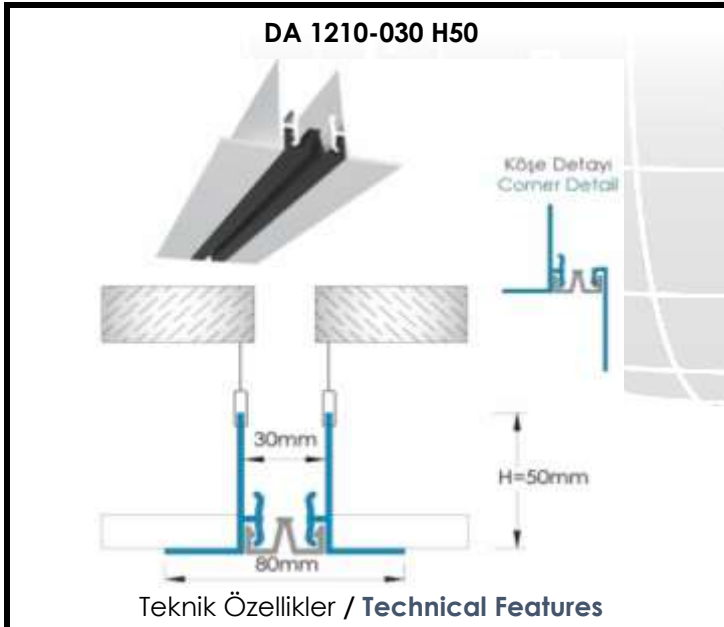

Dilatasyon Derz Açıklığı / Gap	30 mm
Yükseklik / Height	50 mm
Yüzey Genişliği / Surface Width	80 mm
Hareket Kapasitesi / Movement Capacity	± 10 mm

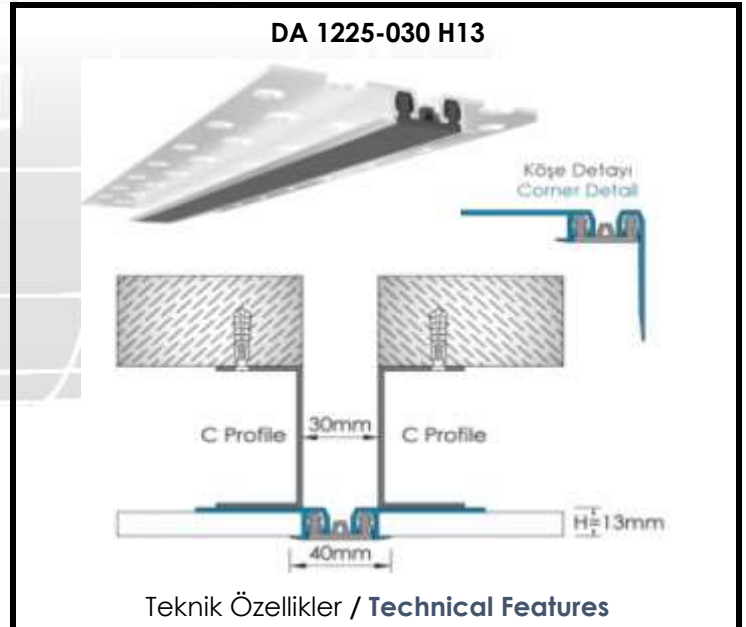

Dilatasyon Derz Açıklığı / Gap	30 mm
Yükseklik / Height	13 mm
Yüzey Genişliği / Surface Width	40 mm
Hareket Kapasitesi / Movement Capacity	± 5 mm



KAFES GROUP
Ostim Osb Mh. 1568 Cd. No:51
06374 Yenimahalle/Ankara/Turkey
Tel.:+90 (0) 535 248 97 85
WEB.: www.kafesgroup.com
EMAIL.: info@kafesgroup.com

KAFES GROUP PROFILE SYSTEMS

3cm Açıklık İçin Duvar-Tavan Dilatasyon Profilleri Wall-Ceiling Expansion Joint Profiles For 3cm Gaps

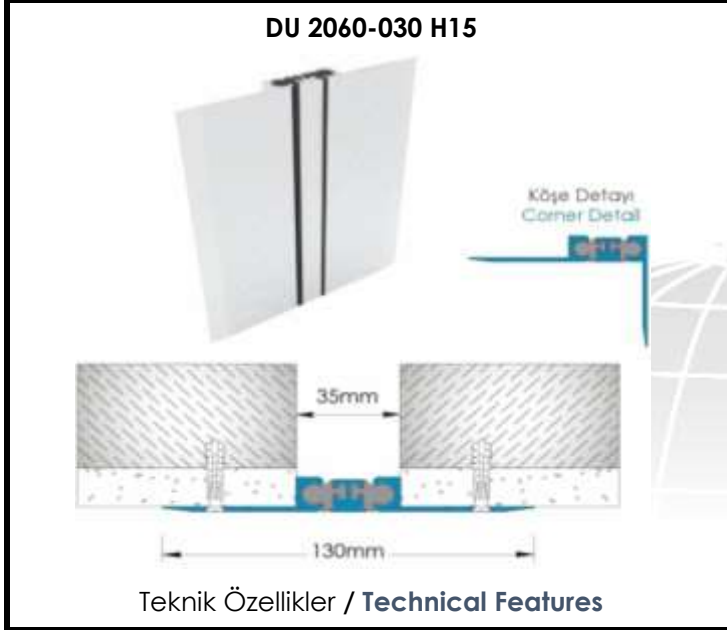

Dilatasyon Derz Açıklığı / Gap	35 mm
Yükseklik / Height	15 mm
Yüzey Genişliği / Surface Width	130 mm
Hareket Kapasitesi / Movement Capacity	± 5 mm

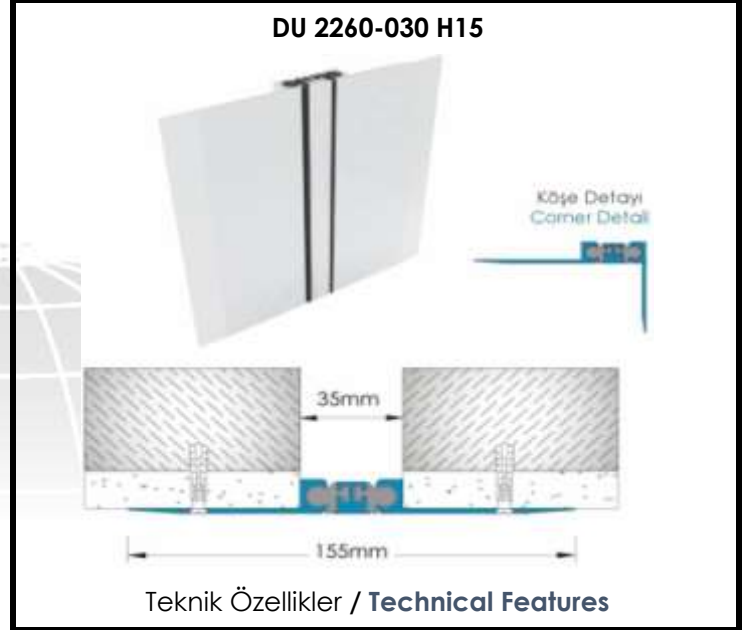

Dilatasyon Derz Açıklığı / Gap	35 mm
Yükseklik / Height	15 mm
Yüzey Genişliği / Surface Width	155 mm
Hareket Kapasitesi / Movement Capacity	± 5 mm

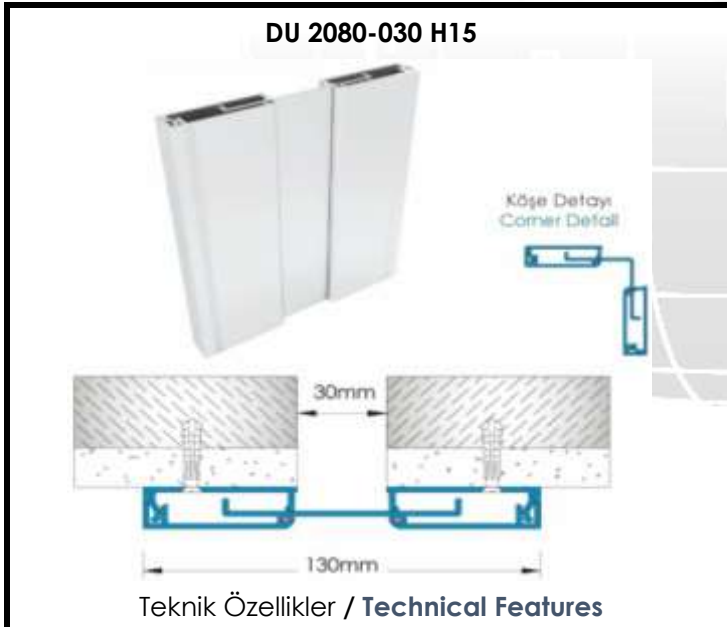

Dilatasyon Derz Açıklığı / Gap	30 mm
Yükseklik / Height	15 mm
Yüzey Genişliği / Surface Width	130 mm
Hareket Kapasitesi / Movement Capacity	± 25 mm

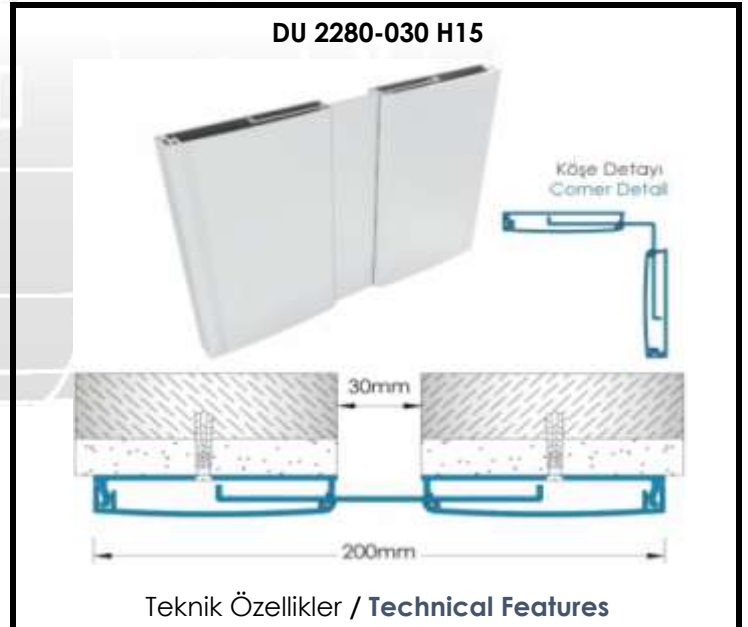

Dilatasyon Derz Açıklığı / Gap	30 mm
Yükseklik / Height	15 mm
Yüzey Genişliği / Surface Width	200 mm
Hareket Kapasitesi / Movement Capacity	± 30 mm



KAFES GROUP
Ostim Osb Mh. 1568 Cd. No:51
06374 Yenimahalle/Ankara/Turkey
Tel.:+90 (0) 535 248 97 85
WEB.: www.kafesgroup.com
EMAIL.: info@kafesgroup.com

KAFES GROUP PROFILE SYSTEMS

3cm Açıklık İçin Zemin Dilatasyon Profilleri Floor Expansion Joint Profiles For 3cm Gaps

ZA 3030-030 H50

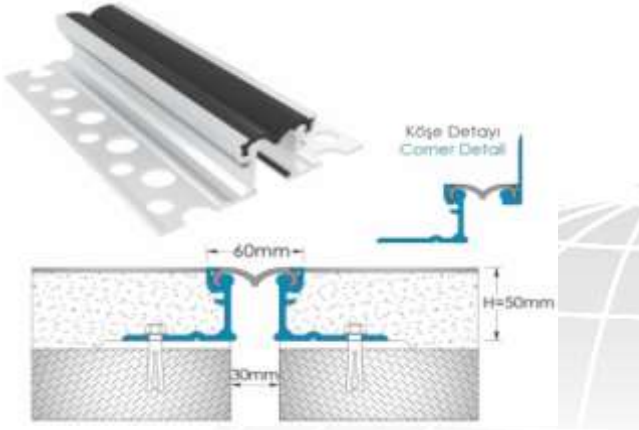

Teknik Özellikler / Technical Features

Dilatasyon Derz Açıklığı / Gap	30 mm
Yükseklik / Height	50 mm
Yüzey Genişliği / Surface Width	60 mm
Hareket Kapasitesi / Movement Capacity	± 10 mm
2,5 ton FORKLİFT, 12 ton KAMYON yüküne dayanıklıdır Resistan to the 2,5 tons FORKLIFT and 12 tons TRUCK load	

ZA 3030-030 H70

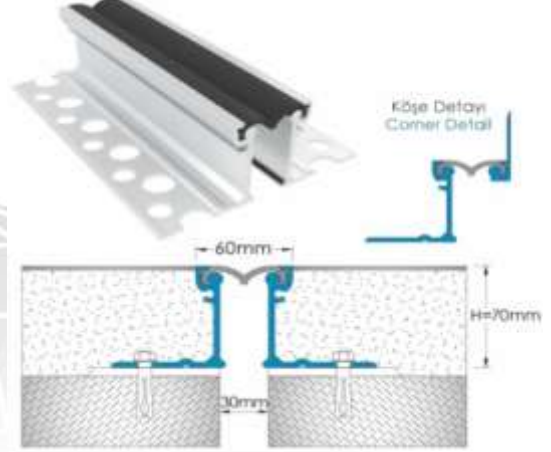

Teknik Özellikler / Technical Features

Dilatasyon Derz Açıklığı / Gap	30 mm
Yükseklik / Height	70 mm
Yüzey Genişliği / Surface Width	60 mm
Hareket Kapasitesi / Movement Capacity	± 10 mm
2,5 ton FORKLİFT, 12 ton KAMYON yüküne dayanıklıdır Resistan to the 2,5 tons FORKLIFT and 12 tons TRUCK load	

ZA 3040-030 H15

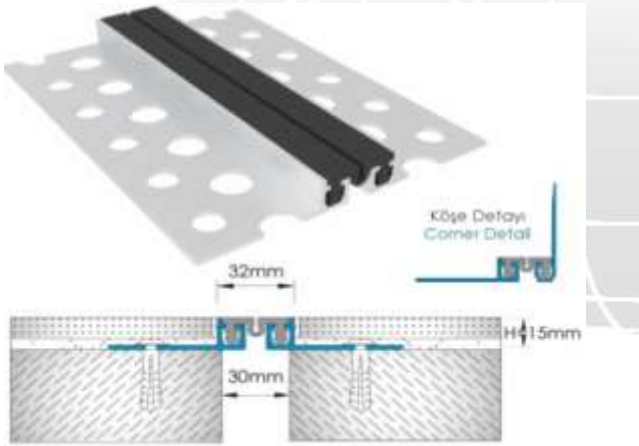

Teknik Özellikler / Technical Features

Dilatasyon Derz Açıklığı / Gap	30 mm
Yükseklik / Height	15 mm
Yüzey Genişliği / Surface Width	130 mm
Hareket Kapasitesi / Movement Capacity	± 25 mm
Yaya trafiğine dayanıklıdır / Resistant for pedestrian traffic	

ZA 3045-030 H15

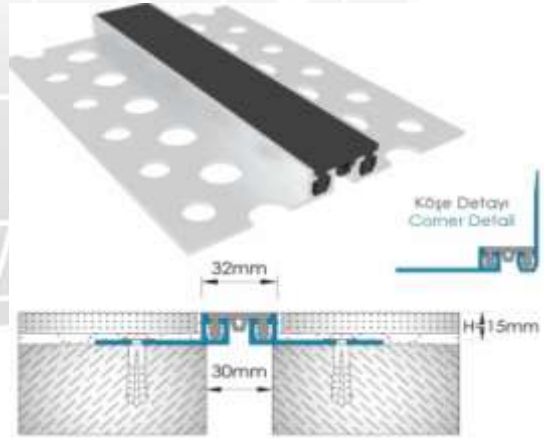

Teknik Özellikler / Technical Features

Dilatasyon Derz Açıklığı / Gap	30 mm
Yükseklik / Height	13 mm
Yüzey Genişliği / Surface Width	200 mm
Hareket Kapasitesi / Movement Capacity	± 30 mm
Yaya trafiğine dayanıklıdır / Resistant for pedestrian traffic	



KAFES GROUP
Ostim Osb Mh. 1568 Cd. No:51
06374 Yenimahalle/Ankara/Turkey
Tel.:+90 (0) 535 248 97 85
WEB.: www.kafesgroup.com
EMAIL.: info@kafesgroup.com

KAFES GROUP PROFILE SYSTEMS

3cm Açıklık İçin Zemin Dilatasyon Profilleri Floor Expansion Joint Profiles For 3cm Gaps

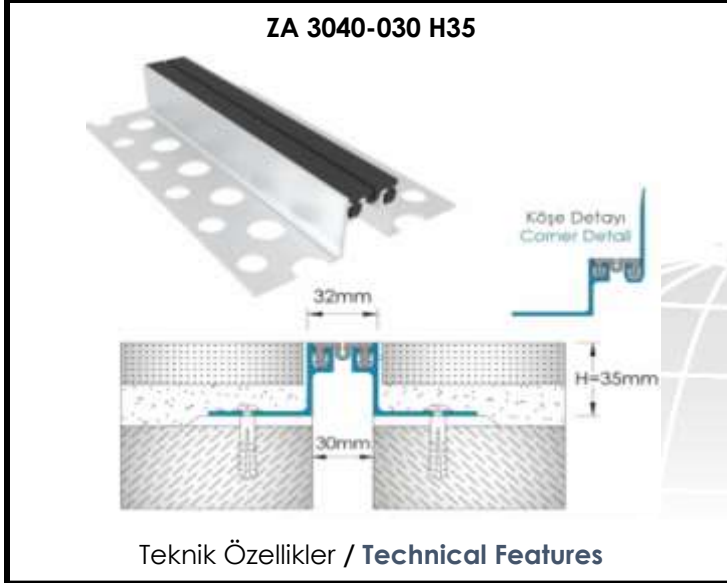

Dilatasyon Derz Açıklığı / Gap	30 mm
Yükseklik / Height	35 mm
Yüzey Genişliği / Surface Width	32 mm
Hareket Kapasitesi / Movement Capacity	± 10 mm
Yaya trafiğine dayanıklıdır / Resistant for pedestrian traffic	

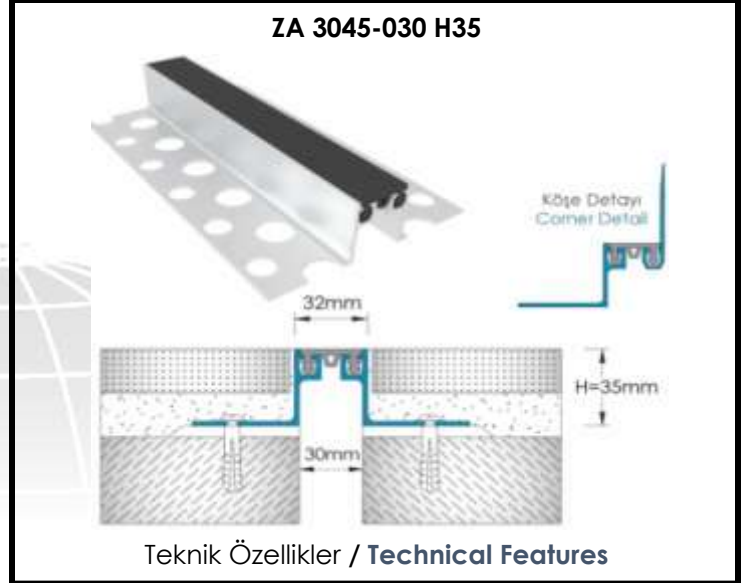

Dilatasyon Derz Açıklığı / Gap	30 mm
Yükseklik / Height	35 mm
Yüzey Genişliği / Surface Width	32 mm
Hareket Kapasitesi / Movement Capacity	± 5 mm
Yaya trafiğine dayanıklıdır / Resistant for pedestrian traffic	

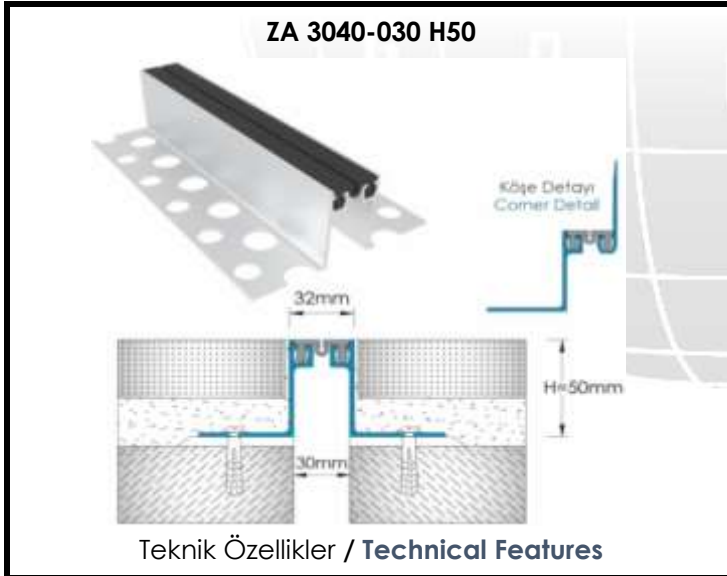

Dilatasyon Derz Açıklığı / Gap	30 mm
Yükseklik / Height	50 mm
Yüzey Genişliği / Surface Width	32 mm
Hareket Kapasitesi / Movement Capacity	± 10 mm
Yaya trafiğine dayanıklıdır / Resistant for pedestrian traffic	

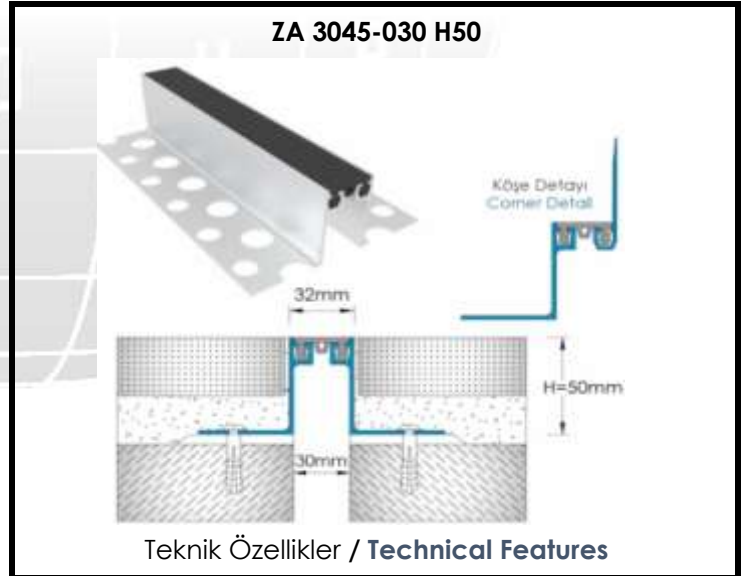

Dilatasyon Derz Açıklığı / Gap	30 mm
Yükseklik / Height	50 mm
Yüzey Genişliği / Surface Width	32 mm
Hareket Kapasitesi / Movement Capacity	± 5 mm
Yaya trafiğine dayanıklıdır / Resistant for pedestrian traffic	



KAFES GROUP
Ostim Osb Mh. 1568 Cd. No:51
06374 Yenimahalle/Ankara/Turkey
Tel.:+90 (0) 535 248 97 85
WEB.: www.kafesgroup.com
EMAIL.: info@kafesgroup.com

KAFES GROUP PROFILE SYSTEMS

3cm Açıklık İçin Zemin Dilatasyon Profilleri Floor Expansion Joint Profiles For 3cm Gaps

ZA 3060-030 H15

Köşe Detayı
Corner Detail

35mm

H=15mm

30mm

Teknik Özellikler / Technical Features

Dilatasyon Derz Açıklığı / Gap	30 mm
Yükseklik / Height	15 mm
Yüzey Genişliği / Surface Width	35 mm
Hareket Kapasitesi / Movement Capacity	± 5 mm
Yaya trafiğine dayanıklıdır / Resistant for pedestrian traffic	

ZA 3060-030 H28

Köşe Detayı
Corner Detail

35mm

H=28mm

30mm

Teknik Özellikler / Technical Features

Dilatasyon Derz Açıklığı / Gap	30 mm
Yükseklik / Height	28 mm
Yüzey Genişliği / Surface Width	35 mm
Hareket Kapasitesi / Movement Capacity	± 5 mm
Yaya trafiğine dayanıklıdır / Resistant for pedestrian traffic	

ZA 3060-030 H43

Köşe Detayı
Corner Detail

35mm

H=43mm

30mm

Teknik Özellikler / Technical Features

Dilatasyon Derz Açıklığı / Gap	30 mm
Yükseklik / Height	43 mm
Yüzey Genişliği / Surface Width	35 mm
Hareket Kapasitesi / Movement Capacity	± 5 mm
Yaya trafiğine dayanıklıdır / Resistant for pedestrian traffic	

ZA 3070-030 H15

Köşe Detayı
Corner Detail

55mm

H=15mm

35mm

Teknik Özellikler / Technical Features

Dilatasyon Derz Açıklığı / Gap	35 mm
Yükseklik / Height	15 mm
Yüzey Genişliği / Surface Width	55 mm
Hareket Kapasitesi / Movement Capacity	± 10 mm
Yaya trafiğine dayanıklıdır / Resistant for pedestrian traffic	



KAFES GROUP
Ostim Osb Mh. 1568 Cd. No:51
06374 Yenimahalle/Ankara/Turkey
Tel.:+90 (0) 535 248 97 85
WEB.: www.kafesgroup.com
EMAIL.: info@kafesgroup.com

KAFES GROUP PROFILE SYSTEMS

3cm Açıklık İçin Zemin Dilatasyon Profilleri Floor Expansion Joint Profiles For 3cm Gaps

ZA 3070-030 H28

Teknik Özellikler / Technical Features

Dilatasyon Derz Açıklığı / Gap	35 mm
Yükseklik / Height	28 mm
Yüzey Genişliği / Surface Width	55 mm
Hareket Kapasitesi / Movement Capacity	± 10 mm
Yaya trafiğine dayanıklıdır / Resistant for pedestrian traffic	

ZA 3070-030 H43

Teknik Özellikler / Technical Features

Dilatasyon Derz Açıklığı / Gap	35 mm
Yükseklik / Height	43 mm
Yüzey Genişliği / Surface Width	55 mm
Hareket Kapasitesi / Movement Capacity	± 10 mm
Yaya trafiğine dayanıklıdır / Resistant for pedestrian traffic	

ZA 3130-030 H15

Teknik Özellikler / Technical Features

Dilatasyon Derz Açıklığı / Gap	30 mm
Yükseklik / Height	15 mm
Yüzey Genişliği / Surface Width	50 mm
Hareket Kapasitesi / Movement Capacity	± 5 mm
Hafif araç trafiğine dayanıklıdır / Resistant for light vehicle traffic	

ZA 3130-030 H50

Teknik Özellikler / Technical Features

Dilatasyon Derz Açıklığı / Gap	30 mm
Yükseklik / Height	50 mm
Yüzey Genişliği / Surface Width	50 mm
Hareket Kapasitesi / Movement Capacity	± 5 mm
Hafif araç trafiğine dayanıklıdır / Resistant for light vehicle traffic	



KAFES GROUP
Ostim Osb Mh. 1568 Cd. No:51
06374 Yenimahalle/Ankara/Turkey
Tel.:+90 (0) 535 248 97 85
WEB.: www.kafesgroup.com
EMAIL.: info@kafesgroup.com

KAFES GROUP PROFILE SYSTEMS

3cm Açıklık İçin Zemin Dilatasyon Profilleri Floor Expansion Joint Profiles For 3cm Gaps

ZU 4020-030 H15

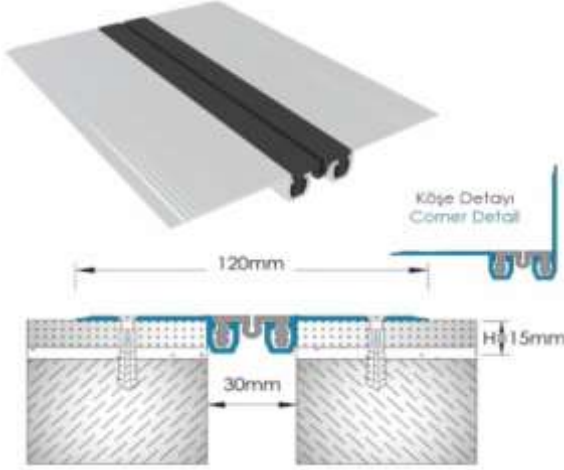

Teknik Özellikler / Technical Features

Dilatasyon Derz Açıklığı / Gap	30 mm
Yükseklik / Height	15 mm
Yüzey Genişliği / Surface Width	120 mm
Hareket Kapasitesi / Movement Capacity	± 10 mm
Yaya trafiğine dayanıklıdır / Resistant for pedestrian traffic	

ZU 4025-030 H15

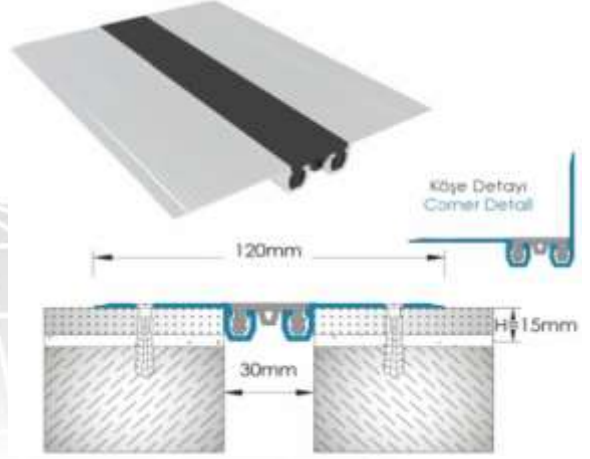

Teknik Özellikler / Technical Features

Dilatasyon Derz Açıklığı / Gap	30 mm
Yükseklik / Height	15 mm
Yüzey Genişliği / Surface Width	120 mm
Hareket Kapasitesi / Movement Capacity	± 5 mm
Yaya trafiğine dayanıklıdır / Resistant for pedestrian traffic	

ZU 4040-030 H15

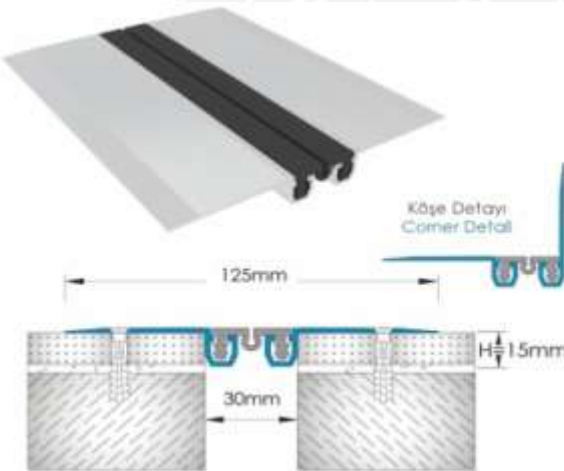

Teknik Özellikler / Technical Features

Dilatasyon Derz Açıklığı / Gap	30 mm
Yükseklik / Height	15 mm
Yüzey Genişliği / Surface Width	125 mm
Hareket Kapasitesi / Movement Capacity	± 10 mm
Yaya trafiğine dayanıklıdır / Resistant for pedestrian traffic	

ZU 4045-030 H15

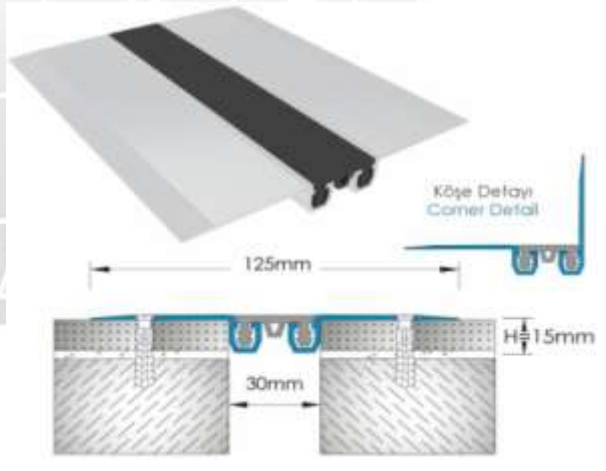

Teknik Özellikler / Technical Features

Dilatasyon Derz Açıklığı / Gap	30 mm
Yükseklik / Height	15 mm
Yüzey Genişliği / Surface Width	125 mm
Hareket Kapasitesi / Movement Capacity	± 5 mm
Yaya trafiğine dayanıklıdır / Resistant for pedestrian traffic	



KAFES GROUP
Ostim Osb Mh. 1568 Cd. No:51
06374 Yenimahalle/Ankara/Turkey
Tel.:+90 (0) 535 248 97 85
WEB.: www.kafesgroup.com
EMAIL.: info@kafesgroup.com

KAFES GROUP PROFILE SYSTEMS

3cm Açıklık İçin Zemin Dilatasyon Profilleri Floor Expansion Joint Profiles For 3cm Gaps

ZU 4050-030 H15

Teknik Özellikler / Technical Features

Dilatasyon Derz Açıklığı / Gap	30 mm
Yükseklik / Height	15 mm
Yüzey Genişliği / Surface Width	150 mm
Hareket Kapasitesi / Movement Capacity	± 10 mm
Yaya trafiğine dayanıklıdır / Resistant for pedestrian traffic	

ZU 4055-030 H15

Teknik Özellikler / Technical Features

Dilatasyon Derz Açıklığı / Gap	30 mm
Yükseklik / Height	15 mm
Yüzey Genişliği / Surface Width	150 mm
Hareket Kapasitesi / Movement Capacity	± 5 mm
Yaya trafiğine dayanıklıdır / Resistant for pedestrian traffic	

ZU 4060-030 H15

Teknik Özellikler / Technical Features

Dilatasyon Derz Açıklığı / Gap	35 mm
Yükseklik / Height	15 mm
Yüzey Genişliği / Surface Width	130 mm
Hareket Kapasitesi / Movement Capacity	± 5 mm
Yaya trafiğine dayanıklıdır / Resistant for pedestrian traffic	

ZU 4060-030 H28

Teknik Özellikler / Technical Features

Dilatasyon Derz Açıklığı / Gap	35 mm
Yükseklik / Height	28 mm
Yüzey Genişliği / Surface Width	130 mm
Hareket Kapasitesi / Movement Capacity	± 5 mm
Hafif araç trafiğine dayanıklıdır / Resistant for light vehicle traffic	



KAFES GROUP
Ostim Osb Mh. 1568 Cd. No:51
06374 Yenimahalle/Ankara/Turkey
Tel.:+90 (0) 535 248 97 85
WEB.: www.kafesgroup.com
EMAIL.: info@kafesgroup.com

KAFES GROUP PROFILE SYSTEMS

5cm Açıklık İçin Duvar-Tavan Dilatasyon Profilleri Wall-Ceiling Expansion Joint Profiles For 5cm Gaps

DA 1000-050 H57

Köşe Detayı
Corner Detail

50mm

H=57mm

56mm

Teknik Özellikler / Technical Features

Dilatasyon Derz Açıklığı / Gap	50 mm
Yükseklik / Height	57 mm
Yüzey Genişliği / Surface Width	56 mm
Hareket Kapasitesi / Movement Capacity	± 20 mm

DA 1040-050 H15

Köşe Detayı
Corner Detail

50mm

50mm

Teknik Özellikler / Technical Features

Dilatasyon Derz Açıklığı / Gap	50 mm
Yükseklik / Height	15 mm
Yüzey Genişliği / Surface Width	50 mm
Hareket Kapasitesi / Movement Capacity	± 10/8 mm

DA 1060-050 H15

Köşe Detayı
Corner Detail

50mm

55mm

Teknik Özellikler / Technical Features

Dilatasyon Derz Açıklığı / Gap	50 mm
Yükseklik / Height	15 mm
Yüzey Genişliği / Surface Width	55 mm
Hareket Kapasitesi / Movement Capacity	± 10 mm

DA 1070-050 H15

Köşe Detayı
Corner Detail

50mm

55mm

Teknik Özellikler / Technical Features

Dilatasyon Derz Açıklığı / Gap	50 mm
Yükseklik / Height	15 mm
Yüzey Genişliği / Surface Width	55 mm
Hareket Kapasitesi / Movement Capacity	± 10 mm



5cm Açıklık İçin Duvar-Tavan Dilatasyon Profilleri Wall-Ceiling Expansion Joint Profiles For 5cm Gaps

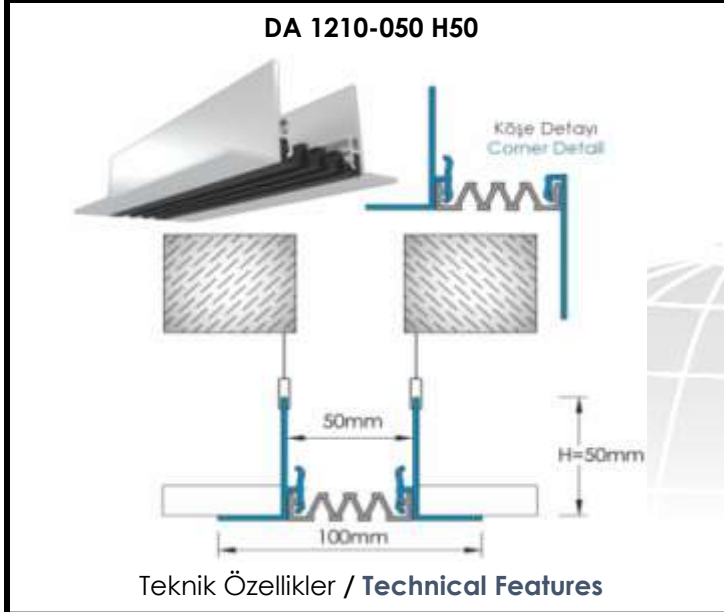

Dilatasyon Derz Açıklığı / Gap	50 mm
Yükseklik / Height	50 mm
Yüzey Genişliği / Surface Width	100 mm
Hareket Kapasitesi / Movement Capacity	± 20 mm

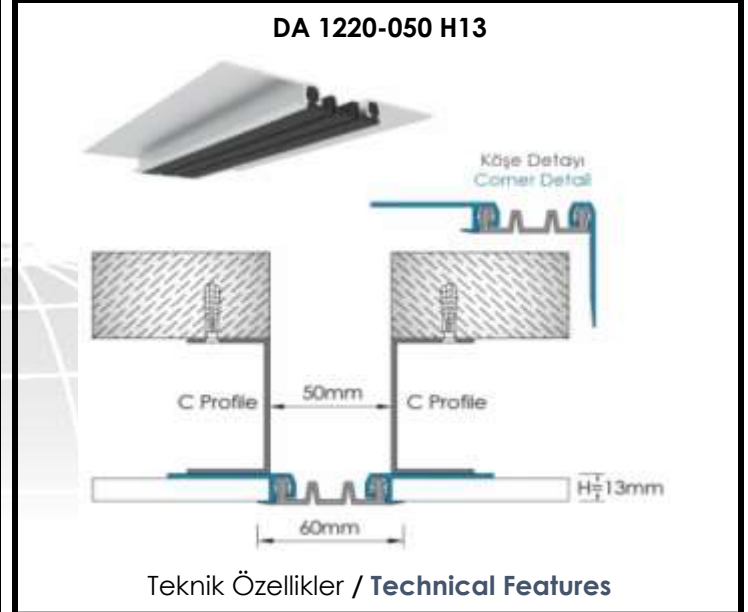

Dilatasyon Derz Açıklığı / Gap	50 mm
Yükseklik / Height	13 mm
Yüzey Genişliği / Surface Width	60 mm
Hareket Kapasitesi / Movement Capacity	± 10/-8 mm



Dilatasyon Derz Açıklığı / Gap	50 mm
Yükseklik / Height	52 mm
Yüzey Genişliği / Surface Width	50 mm
Hareket Kapasitesi / Movement Capacity	± 10/-8 mm

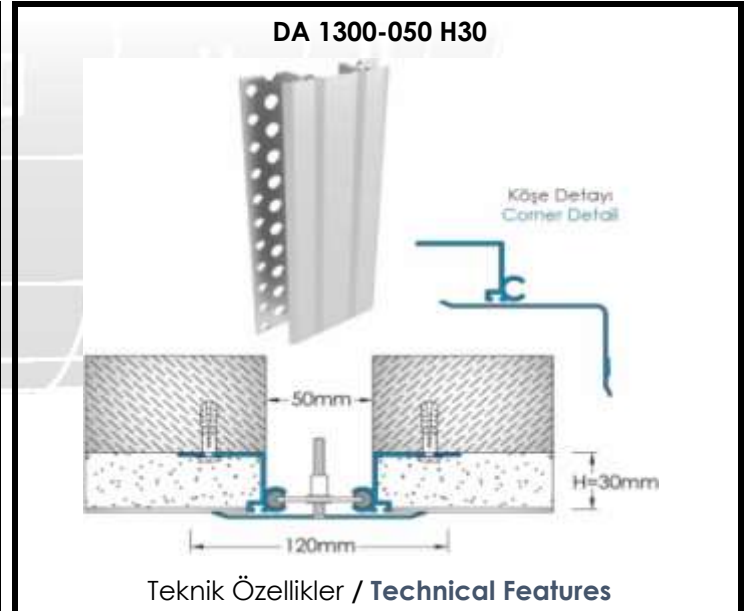

Dilatasyon Derz Açıklığı / Gap	50 mm
Yükseklik / Height	30 mm
Yüzey Genişliği / Surface Width	120 mm
Hareket Kapasitesi / Movement Capacity	± 30/-20 mm



5cm Açıklık İçin Duvar-Tavan Dilatasyon Profilleri Wall-Ceiling Expansion Joint Profiles For 5cm Gaps

DU 2010-050 H15

Köşe Detayı
Corner Detail

50mm

140mm

Teknik Özellikler / Technical Features

Dilatasyon Derz Açıklığı / Gap	50 mm
Yükseklik / Height	15 mm
Yüzey Genişliği / Surface Width	140 mm
Hareket Kapasitesi / Movement Capacity	± 20 mm

DU 2110-050 H15

Köşe Detayı
Corner Detail

50mm

200mm

Teknik Özellikler / Technical Features

Dilatasyon Derz Açıklığı / Gap	50 mm
Yükseklik / Height	15 mm
Yüzey Genişliği / Surface Width	200 mm
Hareket Kapasitesi / Movement Capacity	± 20 mm

DU 2020-050 H15

Köşe Detayı
Corner Detail

50mm

140mm

Teknik Özellikler / Technical Features

Dilatasyon Derz Açıklığı / Gap	50 mm
Yükseklik / Height	15 mm
Yüzey Genişliği / Surface Width	140 mm
Hareket Kapasitesi / Movement Capacity	± 10/-8 mm

DU 2040-050 H15

Köşe Detayı
Corner Detail

50mm

145mm

Teknik Özellikler / Technical Features

Dilatasyon Derz Açıklığı / Gap	50 mm
Yükseklik / Height	15 mm
Yüzey Genişliği / Surface Width	140 mm
Hareket Kapasitesi / Movement Capacity	± 10/-8 mm



KAFES GROUP
Ostim Osb Mh. 1568 Cd. No:51
06374 Yenimahalle/Ankara/Turkey
Tel.:+90 (0) 535 248 97 85
WEB.: www.kafesgroup.com
EMAIL.: info@kafesgroup.com

KAFES GROUP PROFILE SYSTEMS

5cm Açıklık İçin Duvar-Tavan Dilatasyon Profilleri Wall-Ceiling Expansion Joint Profiles For 5cm Gaps

DU 2050-050 H15

Köşe Detayı
Corner Detail

50mm

170mm

Teknik Özellikler / Technical Features

Dilatasyon Derz Açıklığı / Gap	50 mm
Yükseklik / Height	15 mm
Yüzey Genişliği / Surface Width	170 mm
Hareket Kapasitesi / Movement Capacity	± 10/-8 mm

DU 2300-050 H15

50mm

150mm

Teknik Özellikler / Technical Features

Dilatasyon Derz Açıklığı / Gap	50 mm
Yükseklik / Height	15 mm
Yüzey Genişliği / Surface Width	150 mm
Hareket Kapasitesi / Movement Capacity	± 25 mm

DU 2060-050 H15

Köşe Detayı
Corner Detail

55mm

150mm

Teknik Özellikler / Technical Features

Dilatasyon Derz Açıklığı / Gap	55 mm
Yükseklik / Height	15 mm
Yüzey Genişliği / Surface Width	150 mm
Hareket Kapasitesi / Movement Capacity	± 10 mm

DU 2260-050 H15

Köşe Detayı
Corner Detail

55mm

175mm

Teknik Özellikler / Technical Features

Dilatasyon Derz Açıklığı / Gap	55 mm
Yükseklik / Height	15 mm
Yüzey Genişliği / Surface Width	175 mm
Hareket Kapasitesi / Movement Capacity	± 10 mm



KAFES GROUP
Ostim Osb Mh. 1568 Cd. No:51
06374 Yenimahalle/Ankara/Turkey
Tel.:+90 (0) 535 248 97 85
WEB.: www.kafesgroup.com
EMAIL.: info@kafesgroup.com

KAFES GROUP PROFILE SYSTEMS

5cm Açıklık İçin Duvar-Tavan Dilatasyon Profilleri Wall-Ceiling Expansion Joint Profiles For 5cm Gaps

DU 2070-050 H15

Köşe Detayı
Corner Detail

55mm

150mm

Teknik Özellikler / Technical Features

Dilatasyon Derz Açıklığı / Gap	50 mm
Yükseklik / Height	15 mm
Yüzey Genişliği / Surface Width	150 mm
Hareket Kapasitesi / Movement Capacity	± 10 mm

DU 2270-050 H15

Köşe Detayı
Corner Detail

55mm

175mm

Teknik Özellikler / Technical Features

Dilatasyon Derz Açıklığı / Gap	50 mm
Yükseklik / Height	15 mm
Yüzey Genişliği / Surface Width	175 mm
Hareket Kapasitesi / Movement Capacity	± 10 mm

DU 2080-050 H15

Köşe Detayı
Corner Detail

50mm

150mm

Teknik Özellikler / Technical Features

Dilatasyon Derz Açıklığı / Gap	50 mm
Yükseklik / Height	15 mm
Yüzey Genişliği / Surface Width	150 mm
Hareket Kapasitesi / Movement Capacity	± 40 mm

DU 2280-050 H15

Köşe Detayı
Corner Detail

50mm

220mm

Teknik Özellikler / Technical Features

Dilatasyon Derz Açıklığı / Gap	50 mm
Yükseklik / Height	15 mm
Yüzey Genişliği / Surface Width	220 mm
Hareket Kapasitesi / Movement Capacity	± 50 mm



KAFES GROUP
Ostim Osb Mh. 1568 Cd. No:51
06374 Yenimahalle/Ankara/Turkey
Tel.:+90 (0) 535 248 97 85
WEB.: www.kafesgroup.com
EMAIL.: info@kafesgroup.com

KAFES GROUP PROFILE SYSTEMS

5cm Açıklık İçin Zemin Dilatasyon Profilleri Floor Expansion Joint Profiles For 3cm Gaps

ZA 3000-050 H45

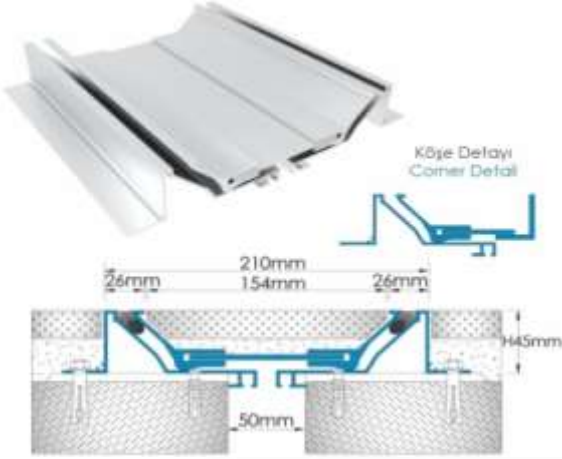

Teknik Özellikler / Technical Features

Dilatasyon Derz Açıklığı / Gap	50 mm
Yükseklik / Height	45 mm
Yüzey Genişliği / Surface Width	210 mm
Hareket Kapasitesi / Movement Capacity	± 25 mm
Yaya trafiğine dayanıklıdır / Resistant for pedestrian traffic	

ZA 3050-050 H70

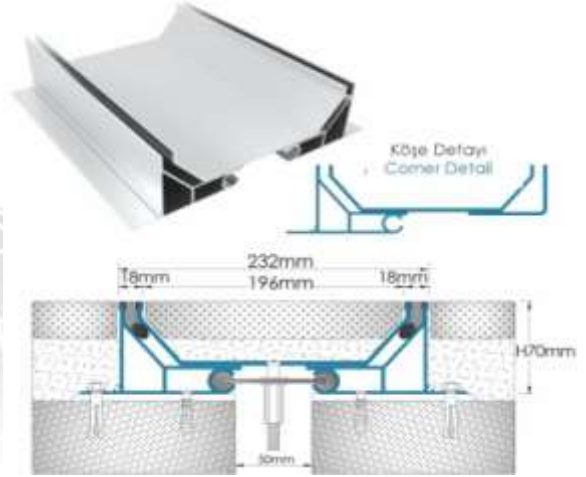

Teknik Özellikler / Technical Features

Dilatasyon Derz Açıklığı / Gap	50 mm
Yükseklik / Height	70 mm
Yüzey Genişliği / Surface Width	232 mm
Hareket Kapasitesi / Movement Capacity	± 25 mm
Yaya trafiğine dayanıklıdır / Resistant for pedestrian traffic	

ZA 3100-050 H40

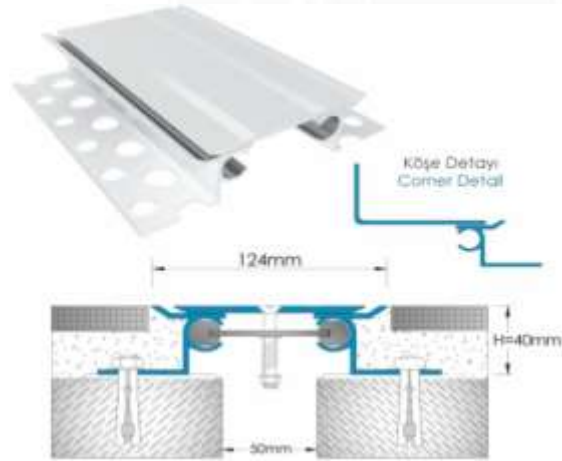

Teknik Özellikler / Technical Features

Dilatasyon Derz Açıklığı / Gap	50 mm
Yükseklik / Height	40 mm
Yüzey Genişliği / Surface Width	124 mm
Hareket Kapasitesi / Movement Capacity	± 25 mm
Yaya trafiğine dayanıklıdır / Resistant for pedestrian traffic	

ZA 3150-050 H40

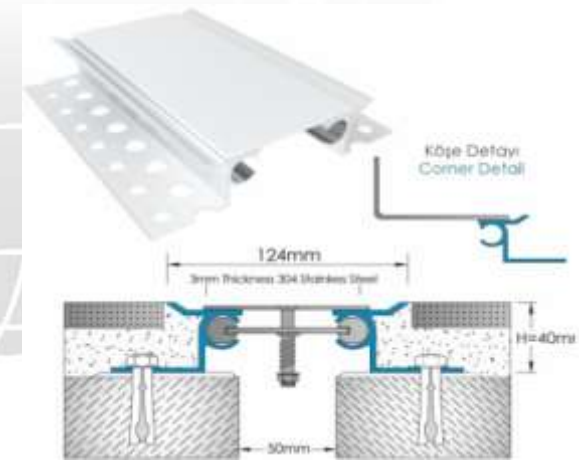

Teknik Özellikler / Technical Features

Dilatasyon Derz Açıklığı / Gap	50 mm
Yükseklik / Height	40 mm
Yüzey Genişliği / Surface Width	124 mm
Hareket Kapasitesi / Movement Capacity	± 25 mm
4,5 ton FORKLİFT, 12 ton KAMYON yüküne dayanıklıdır Resistant to the 4,5 tons FORKLIFT and 12 tons TRUCK load	



KAFES GROUP
Ostim Osb Mh. 1568 Cd. No:51
06374 Yenimahalle/Ankara/Turkey
Tel.:+90 (0) 535 248 97 85
WEB.: www.kafesgroup.com
EMAIL.: info@kafesgroup.com

KAFES GROUP PROFILE SYSTEMS

5cm Açıklık İçin Zemin Dilatasyon Profilleri Floor Expansion Joint Profiles For 3cm Gaps

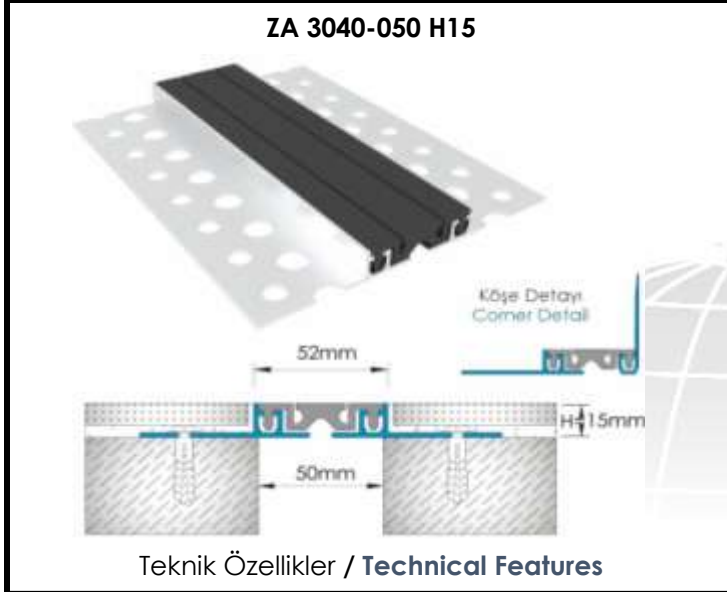

Dilatasyon Derz Açıklığı / Gap	50 mm
Yükseklik / Height	15 mm
Yüzey Genişliği / Surface Width	52 mm
Hareket Kapasitesi / Movement Capacity	± 10 mm
Yaya trafiğine dayanıklıdır / Resistant for pedestrian traffic	

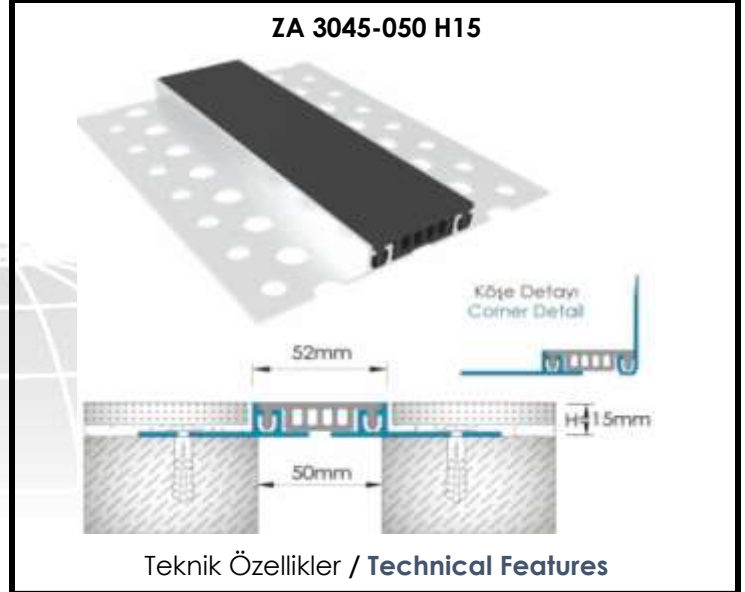

Dilatasyon Derz Açıklığı / Gap	50 mm
Yükseklik / Height	15 mm
Yüzey Genişliği / Surface Width	52 mm
Hareket Kapasitesi / Movement Capacity	± 6 mm
Yaya trafiğine dayanıklıdır / Resistant for pedestrian traffic	

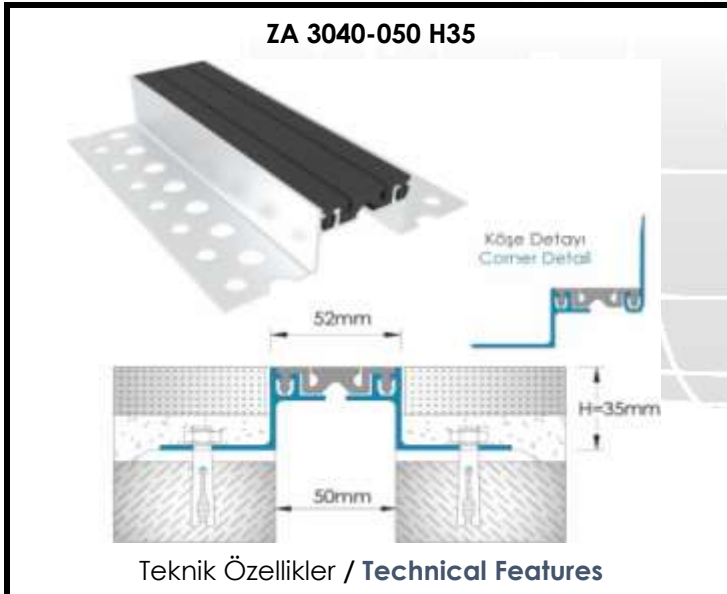

Dilatasyon Derz Açıklığı / Gap	50 mm
Yükseklik / Height	35 mm
Yüzey Genişliği / Surface Width	52 mm
Hareket Kapasitesi / Movement Capacity	± 10 mm
Yaya trafiğine dayanıklıdır / Resistant for pedestrian traffic	

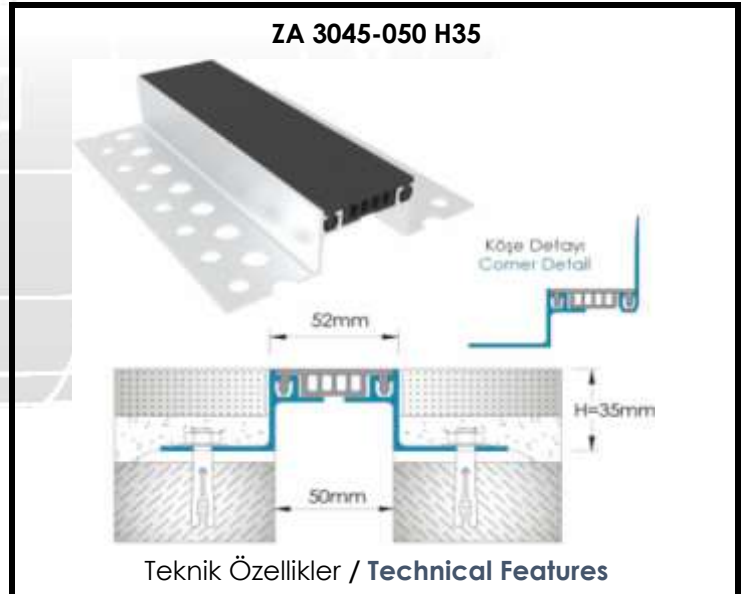

Dilatasyon Derz Açıklığı / Gap	50 mm
Yükseklik / Height	35 mm
Yüzey Genişliği / Surface Width	52 mm
Hareket Kapasitesi / Movement Capacity	± 6 mm
Yaya trafiğine dayanıklıdır / Resistant for pedestrian traffic	



KAFES GROUP
Ostim Osb Mh. 1568 Cd. No:51
06374 Yenimahalle/Ankara/Turkey
Tel.:+90 (0) 535 248 97 85
WEB.: www.kafesgroup.com
EMAIL.: info@kafesgroup.com

KAFES GROUP PROFILE SYSTEMS

5cm Açıklık İçin Zemin Dilatasyon Profilleri Floor Expansion Joint Profiles For 3cm Gaps

ZA 3040-050 H50

Köşe Detayı
Corner Detail

52mm

H=50mm

50mm

Teknik Özellikler / Technical Features

Dilatasyon Derz Açıklığı / Gap	50 mm
Yükseklik / Height	50 mm
Yüzey Genişliği / Surface Width	52 mm
Hareket Kapasitesi / Movement Capacity	± 10 mm
Yaya trafiğine dayanıklıdır / Resistant for pedestrian traffic	

ZA 3045-050 H50

Köşe Detayı
Corner Detail

52mm

H=50mm

50mm

Teknik Özellikler / Technical Features

Dilatasyon Derz Açıklığı / Gap	50 mm
Yükseklik / Height	50 mm
Yüzey Genişliği / Surface Width	52 mm
Hareket Kapasitesi / Movement Capacity	± 10 mm
Yaya trafiğine dayanıklıdır / Resistant for pedestrian traffic	

ZA 3240-050 H35

Köşe Detayı
Corner Detail

52mm

H=35mm

50mm

Teknik Özellikler / Technical Features

Dilatasyon Derz Açıklığı / Gap	50 mm
Yükseklik / Height	35 mm
Yüzey Genişliği / Surface Width	52 mm
Hareket Kapasitesi / Movement Capacity	± 10 mm
Hafif araç trafiğine dayanıklıdır / Resistant for light vehicle traffic	

ZA 3245-050 H35

Köşe Detayı
Corner Detail

52mm

H=35mm

50mm

Teknik Özellikler / Technical Features

Dilatasyon Derz Açıklığı / Gap	50 mm
Yükseklik / Height	35 mm
Yüzey Genişliği / Surface Width	52 mm
Hareket Kapasitesi / Movement Capacity	± 10 mm
Hafif araç trafiğine dayanıklıdır / Resistant for light vehicle traffic	



KAFES GROUP
Ostim Osb Mh. 1568 Cd. No:51
06374 Yenimahalle/Ankara/Turkey
Tel.:+90 (0) 535 248 97 85
WEB.: www.kafesgroup.com
EMAIL.: info@kafesgroup.com

KAFES GROUP PROFILE SYSTEMS

5cm Açıklık İçin Zemin Dilatasyon Profilleri Floor Expansion Joint Profiles For 3cm Gaps

ZA 3240-050 H50

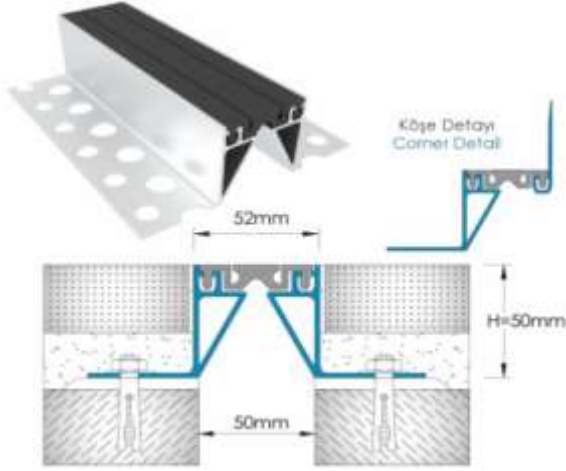

Teknik Özellikler / Technical Features

Dilatasyon Derz Açıklığı / Gap	50 mm
Yükseklik / Height	50 mm
Yüzey Genişliği / Surface Width	52 mm
Hareket Kapasitesi / Movement Capacity	± 10 mm
Hafif araç trafiğine dayanıklıdır / Resistant for light vehicle traffic	

ZA 3245-050 H50

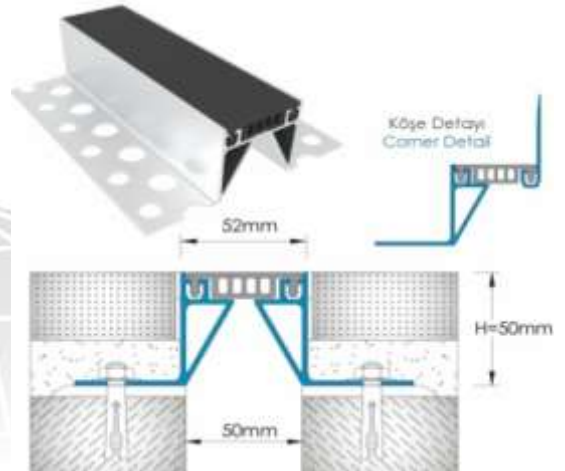

Teknik Özellikler / Technical Features

Dilatasyon Derz Açıklığı / Gap	50 mm
Yükseklik / Height	50 mm
Yüzey Genişliği / Surface Width	52 mm
Hareket Kapasitesi / Movement Capacity	± 6 mm
Hafif araç trafiğine dayanıklıdır / Resistant for light vehicle traffic	

ZA 3340-050 H50

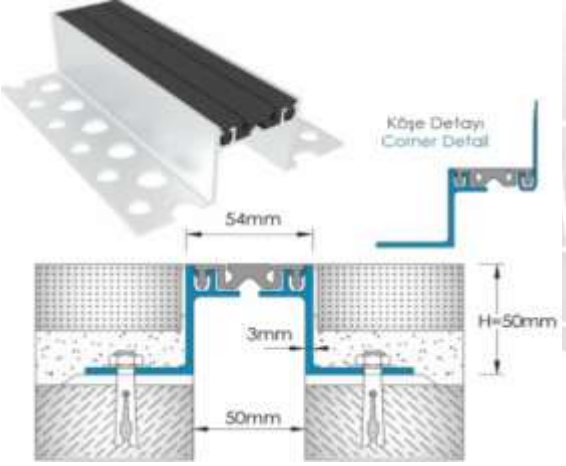

Teknik Özellikler / Technical Features

Dilatasyon Derz Açıklığı / Gap	50 mm
Yükseklik / Height	50 mm
Yüzey Genişliği / Surface Width	54 mm
Hareket Kapasitesi / Movement Capacity	± 10 mm
6,5 ton FORKLİFT, 30 ton KAMYON yüküne dayanıklıdır Resistan to the 6,5 tons FORKLIFT and 30 tons TRUCK load	

ZA 3345-050 H50

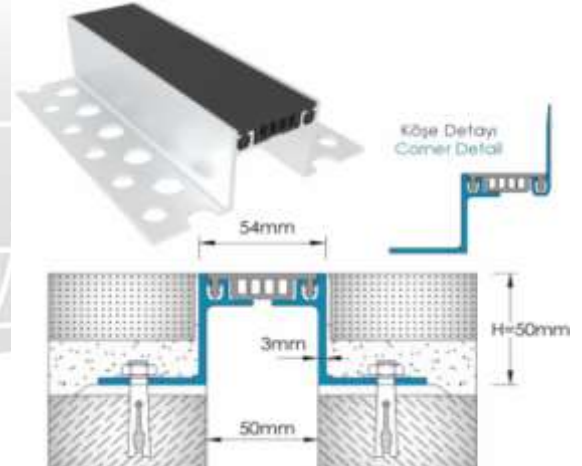

Teknik Özellikler / Technical Features

Dilatasyon Derz Açıklığı / Gap	50 mm
Yükseklik / Height	50 mm
Yüzey Genişliği / Surface Width	54 mm
Hareket Kapasitesi / Movement Capacity	± 6 mm
6,5 ton FORKLİFT, 30 ton KAMYON yüküne dayanıklıdır Resistan to the 6,5 tons FORKLIFT and 30 tons TRUCK load	



KAFES GROUP
Ostim Osb Mh. 1568 Cd. No:51
06374 Yenimahalle/Ankara/Turkey
Tel.:+90 (0) 535 248 97 85
WEB.: www.kafesgroup.com
EMAIL.: info@kafesgroup.com

KAFES GROUP PROFILE SYSTEMS

5cm Açıklık İçin Zemin Dilatasyon Profilleri Floor Expansion Joint Profiles For 3cm Gaps

ZA 3260-050 H15

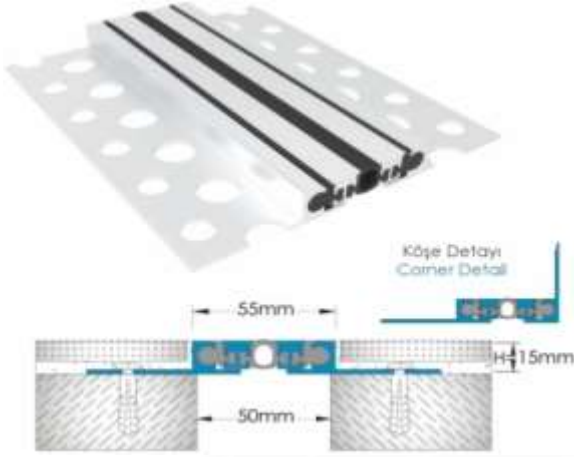

Teknik Özellikler / Technical Features

Dilatasyon Derz Açıklığı / Gap	50 mm
Yükseklik / Height	15 mm
Yüzey Genişliği / Surface Width	55 mm
Hareket Kapasitesi / Movement Capacity	± 10 mm
Yaya trafiğine dayanıklıdır / Resistant for pedestrian traffic	

ZA 3260-050 H20

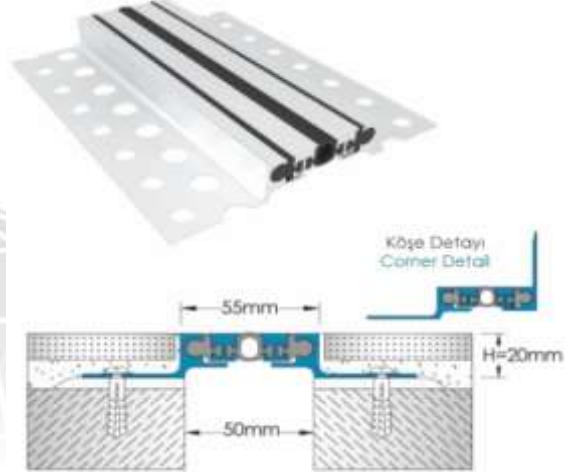

Teknik Özellikler / Technical Features

Dilatasyon Derz Açıklığı / Gap	50 mm
Yükseklik / Height	20 mm
Yüzey Genişliği / Surface Width	55 mm
Hareket Kapasitesi / Movement Capacity	± 10 mm
Hafif araç trafiğine dayanıklıdır / Resistant for light vehicle traffic	

ZA 3260-050 H23

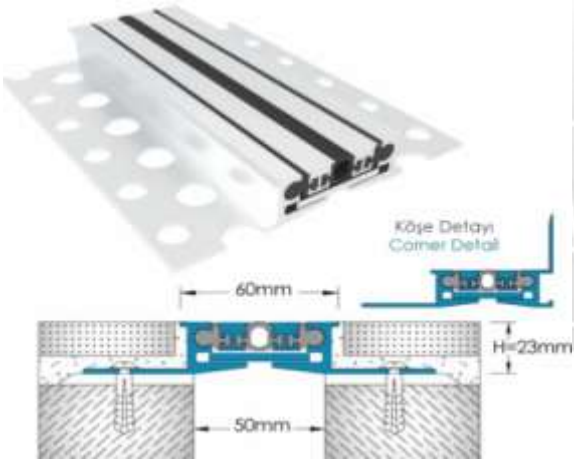

Teknik Özellikler / Technical Features

Dilatasyon Derz Açıklığı / Gap	50 mm
Yükseklik / Height	23 mm
Yüzey Genişliği / Surface Width	60 mm
Hareket Kapasitesi / Movement Capacity	± 10 mm
Hafif araç trafiğine dayanıklıdır / Resistant for light vehicle traffic	

ZA 3260-050 H43

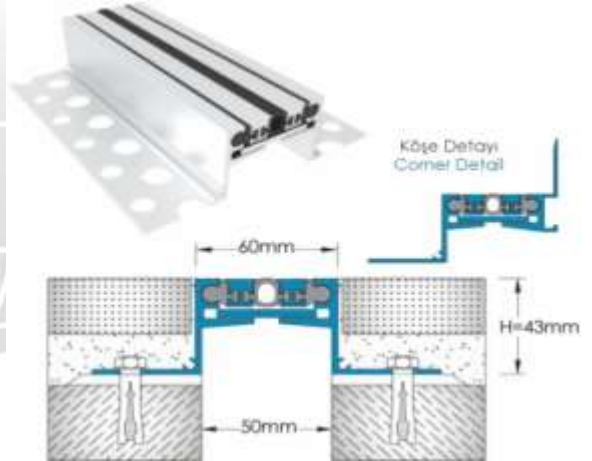

Teknik Özellikler / Technical Features

Dilatasyon Derz Açıklığı / Gap	50 mm
Yükseklik / Height	43 mm
Yüzey Genişliği / Surface Width	60 mm
Hareket Kapasitesi / Movement Capacity	± 10 mm
3,5 ton FORKLİFT, 15 ton KAMYON yüküne dayanıklıdır Resistant to the 3,5 tons FORKLIFT and 15 tons TRUCK load	



KAFES GROUP
Ostim Osb Mh. 1568 Cd. No:51
06374 Yenimahalle/Ankara/Turkey
Tel.:+90 (0) 535 248 97 85
WEB.: www.kafesgroup.com
EMAIL.: info@kafesgroup.com

KAFES GROUP PROFILE SYSTEMS

5cm Açıklık İçin Zemin Dilatasyon Profilleri Floor Expansion Joint Profiles For 3cm Gaps

ZA 3500-050 H28

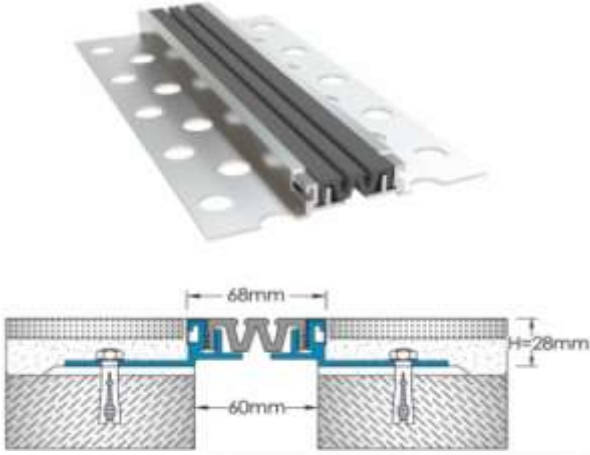

Teknik Özellikler / Technical Features

Dilatasyon Derz Açıklığı / Gap	60 mm
Yükseklik / Height	28 mm
Yüzey Genişliği / Surface Width	68 mm
Hareket Kapasitesi / Movement Capacity	± 10 mm
7 ton FORKLİFT, 30 ton KAMYON yüküne dayanıklıdır Resistan to the 7 tons FORKLIFT and 30 tons TRUCK load	

ZA 3500-050 H50

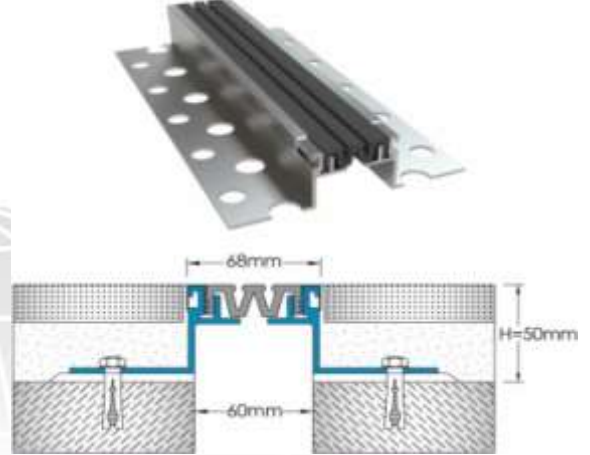

Teknik Özellikler / Technical Features

Dilatasyon Derz Açıklığı / Gap	60 mm
Yükseklik / Height	50 mm
Yüzey Genişliği / Surface Width	68 mm
Hareket Kapasitesi / Movement Capacity	± 10 mm
7 ton FORKLİFT, 30 ton KAMYON yüküne dayanıklıdır Resistan to the 7 tons FORKLIFT and 30 tons TRUCK load	

ZA 3030-050 H50

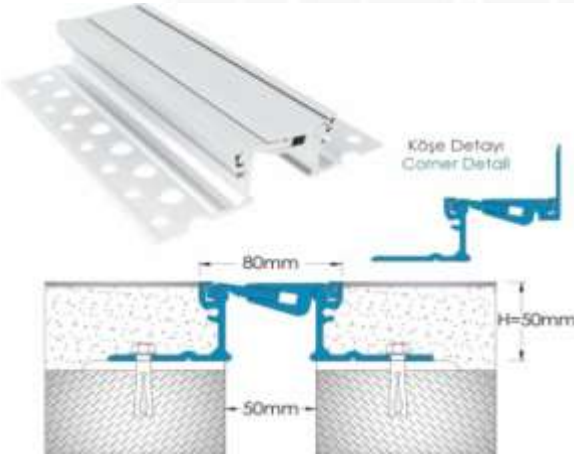

Teknik Özellikler / Technical Features

Dilatasyon Derz Açıklığı / Gap	50 mm
Yükseklik / Height	50 mm
Yüzey Genişliği / Surface Width	80 mm
Hareket Kapasitesi / Movement Capacity	± 10 mm
6,5 ton FORKLİFT, 30 ton KAMYON yüküne dayanıklıdır Resistan to the 6,5 tons FORKLIFT and 30 tons TRUCK load	

ZA 3030-050 H70

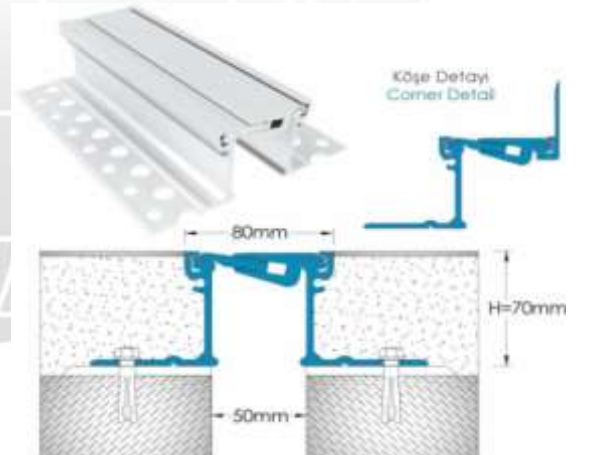

Teknik Özellikler / Technical Features

Dilatasyon Derz Açıklığı / Gap	50 mm
Yükseklik / Height	70 mm
Yüzey Genişliği / Surface Width	80 mm
Hareket Kapasitesi / Movement Capacity	± 10 mm
6,5 ton FORKLİFT, 30 ton KAMYON yüküne dayanıklıdır Resistan to the 6,5 tons FORKLIFT and 30 tons TRUCK load	



KAFES GROUP
Ostim Osb Mh. 1568 Cd. No:51
06374 Yenimahalle/Ankara/Turkey
Tel.:+90 (0) 535 248 97 85
WEB.: www.kafesgroup.com
EMAIL.: info@kafesgroup.com

KAFES GROUP PROFILE SYSTEMS

5cm Açıklık İçin Zemin Dilatasyon Profilleri Floor Expansion Joint Profiles For 3cm Gaps

ZA 3130-050 H15

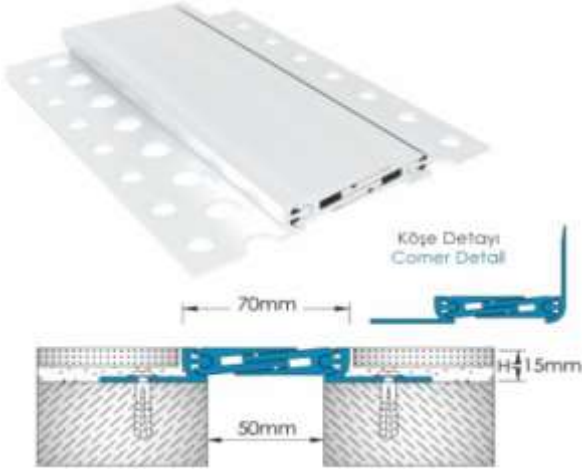

Teknik Özellikler / Technical Features

Dilatasyon Derz Açıklığı / Gap	50 mm
Yükseklik / Height	15 mm
Yüzey Genişliği / Surface Width	70 mm
Hareket Kapasitesi / Movement Capacity	± 5 mm
Hafif araç trafiğine dayanıklıdır / Resistant for light vehicle traffic	

ZA 3130-050 H50

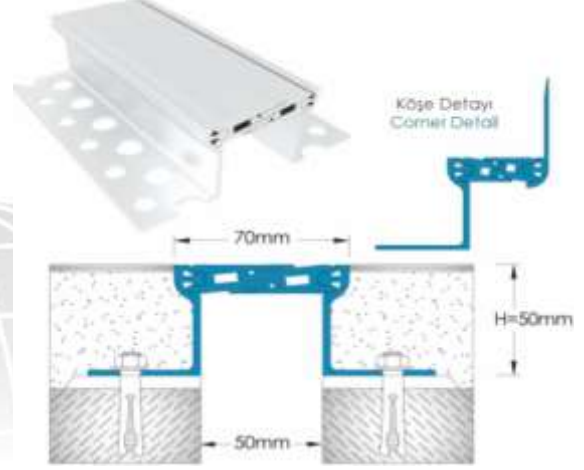

Teknik Özellikler / Technical Features

Dilatasyon Derz Açıklığı / Gap	50 mm
Yükseklik / Height	50 mm
Yüzey Genişliği / Surface Width	70 mm
Hareket Kapasitesi / Movement Capacity	± 5 mm
6,5 ton FORKLİFT, 30 ton KAMYON yüküne dayanıklıdır Resistant to the 6,5 tons FORKLİFT and 30 tons TRUCK load	

ZA 3250-050 H25



Teknik Özellikler / Technical Features

Dilatasyon Derz Açıklığı / Gap	50 mm
Yükseklik / Height	25 mm
Yüzey Genişliği / Surface Width	200 mm
Hareket Kapasitesi / Movement Capacity	± 25 mm
Hafif araç trafiğine dayanıklıdır / Resistant for light vehicle traffic	

ZA 3250-050 H30

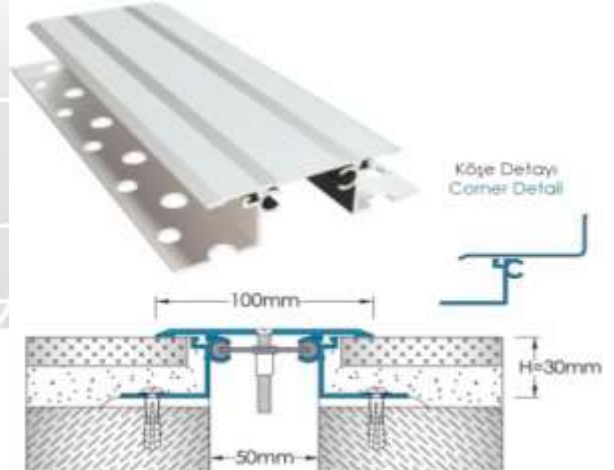

Teknik Özellikler / Technical Features

Dilatasyon Derz Açıklığı / Gap	50 mm
Yükseklik / Height	30 mm
Yüzey Genişliği / Surface Width	100 mm
Hareket Kapasitesi / Movement Capacity	± 25 mm
Hafif araç trafiğine dayanıklıdır / Resistant for light vehicle traffic	



KAFES GROUP
Ostim Osb Mh. 1568 Cd. No:51
06374 Yenimahalle/Ankara/Turkey
Tel.:+90 (0) 535 248 97 85
WEB.: www.kafesgroup.com
EMAIL.: info@kafesgroup.com

KAFES GROUP PROFILE SYSTEMS

5cm Açıklık İçin Zemin Dilatasyon Profilleri Floor Expansion Joint Profiles For 3cm Gaps

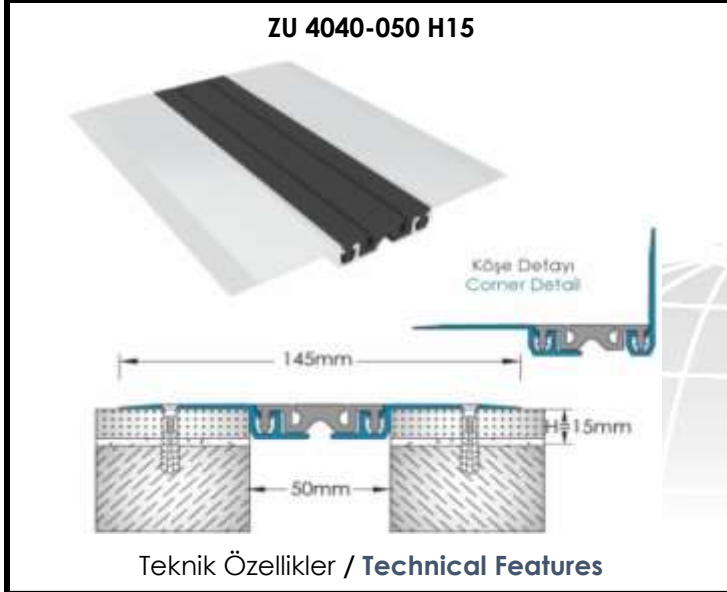

Dilatasyon Derz Açıklığı / Gap	50 mm
Yükseklik / Height	15 mm
Yüzey Genişliği / Surface Width	145 mm
Hareket Kapasitesi / Movement Capacity	± 10 mm
Yaya trafiğine dayanıklıdır / Resistant for pedestrian traffic	

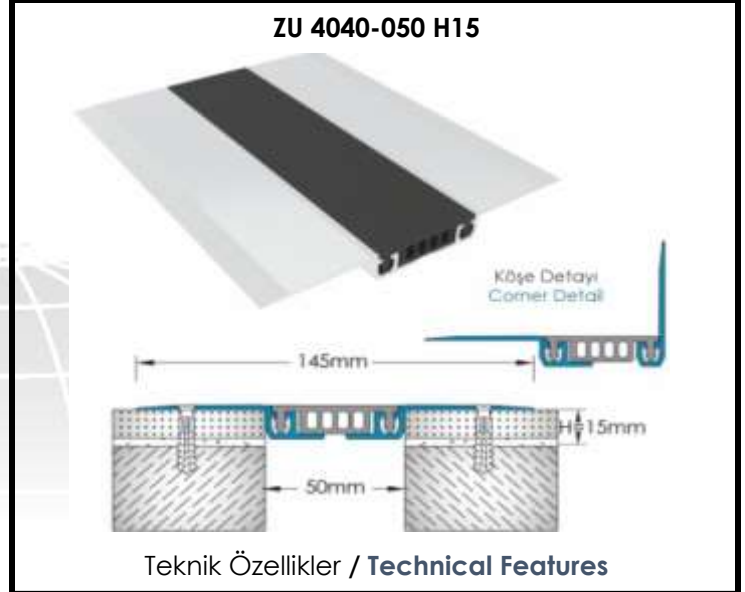

Dilatasyon Derz Açıklığı / Gap	50 mm
Yükseklik / Height	15 mm
Yüzey Genişliği / Surface Width	145 mm
Hareket Kapasitesi / Movement Capacity	± 06 mm
Yaya trafiğine dayanıklıdır / Resistant for pedestrian traffic	

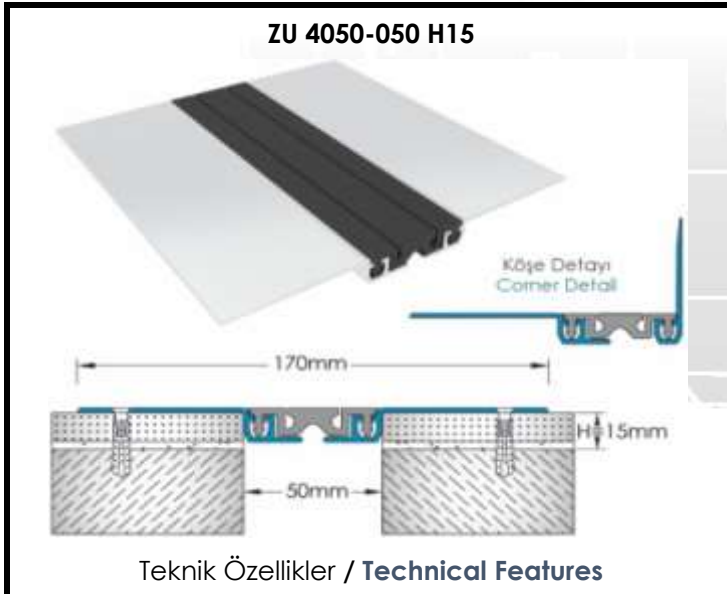

Dilatasyon Derz Açıklığı / Gap	50 mm
Yükseklik / Height	15 mm
Yüzey Genişliği / Surface Width	170 mm
Hareket Kapasitesi / Movement Capacity	± 10 mm
Yaya trafiğine dayanıklıdır / Resistant for pedestrian traffic	

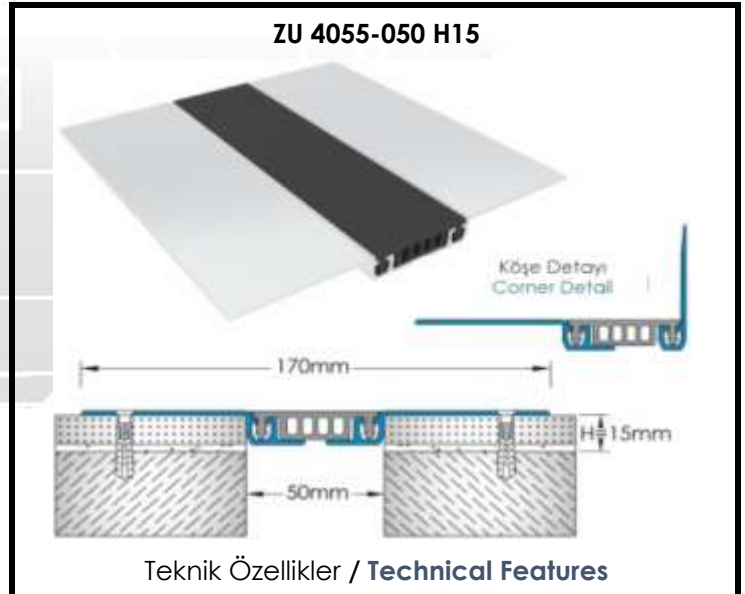

Dilatasyon Derz Açıklığı / Gap	50 mm
Yükseklik / Height	15 mm
Yüzey Genişliği / Surface Width	170 mm
Hareket Kapasitesi / Movement Capacity	± 06 mm
Hafif araç trafiğine dayanıklıdır / Resistant for light vehicle traffic	



KAFES GROUP
Ostim Osb Mh. 1568 Cd. No:51
06374 Yenimahalle/Ankara/Turkey
Tel.:+90 (0) 535 248 97 85
WEB.: www.kafesgroup.com
EMAIL.: info@kafesgroup.com

KAFES GROUP PROFILE SYSTEMS

5cm Açıklık İçin Zemin Dilatasyon Profilleri Floor Expansion Joint Profiles For 3cm Gaps

ZU 4060-050 H15

Teknik Özellikler / Technical Features

Dilatasyon Derz Açıklığı / Gap	55 mm
Yükseklik / Height	15 mm
Yüzey Genişliği / Surface Width	150 mm
Hareket Kapasitesi / Movement Capacity	10
Yaya trafiğine dayanıklıdır / Resistant for pedestrian traffic	

ZU 4060-050 H23

Teknik Özellikler / Technical Features

Dilatasyon Derz Açıklığı / Gap	55 mm
Yükseklik / Height	23 mm
Yüzey Genişliği / Surface Width	175 mm
Hareket Kapasitesi / Movement Capacity	10
Hafif araç trafiğine dayanıklıdır / Resistant for light vehicle traffic	

ZU 4030-050 H14

Teknik Özellikler / Technical Features

Dilatasyon Derz Açıklığı / Gap	50 mm
Yükseklik / Height	25 mm
Yüzey Genişliği / Surface Width	200 mm
Hareket Kapasitesi / Movement Capacity	± 25 mm
2,5 ton FORKLİFT, 12 ton KAMYON yüküne dayanıklıdır Resistan to the 2,5 tons FORKLIFT and 12 tons TRUCK load	

ZU 4130-050 H14

Teknik Özellikler / Technical Features

Dilatasyon Derz Açıklığı / Gap	50 mm
Yükseklik / Height	30 mm
Yüzey Genişliği / Surface Width	100 mm
Hareket Kapasitesi / Movement Capacity	± 25 mm
Hafif araç trafiğine dayanıklıdır / Resistant for light vehicle traffic	



KAFES GROUP
Ostim Osb Mh. 1568 Cd. No:51
06374 Yenimahalle/Ankara/Turkey
Tel.:+90 (0) 535 248 97 85
WEB.: www.kafesgroup.com
EMAIL.: info@kafesgroup.com

KAFES GROUP PROFILE SYSTEMS

5cm Açıklık İçin Zemin Dilatasyon Profilleri Floor Expansion Joint Profiles For 3cm Gaps

ZU 4070-050 H15

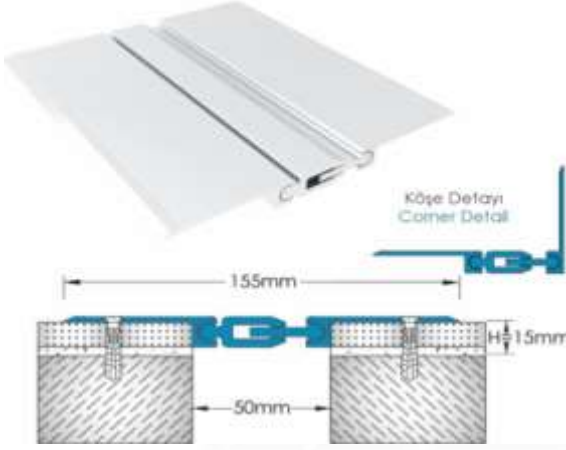

Teknik Özellikler / Technical Features

Dilatasyon Derz Açıklığı / Gap	50 mm
Yükseklik / Height	15 mm
Yüzey Genişliği / Surface Width	155 mm
Hareket Kapasitesi / Movement Capacity	± 10 mm
Yaya trafiğine dayanıklıdır / Resistant for pedestrian traffic	

ZU 4070-050 H28

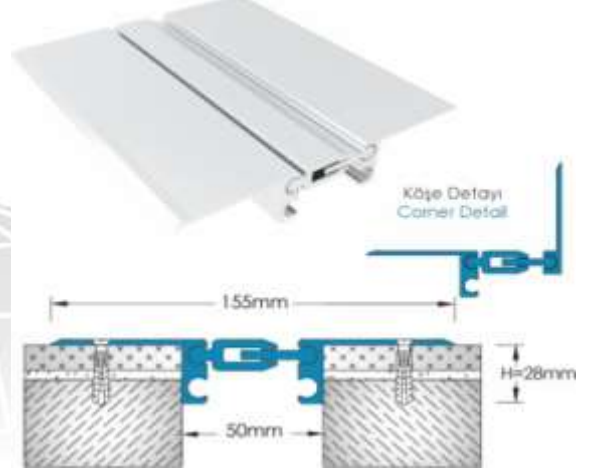

Teknik Özellikler / Technical Features

Dilatasyon Derz Açıklığı / Gap	50 mm
Yükseklik / Height	15 mm
Yüzey Genişliği / Surface Width	155 mm
Hareket Kapasitesi / Movement Capacity	± 10 mm
Hafif araç trafiğine dayanıklıdır / Resistant for light vehicle traffic	

ZU 4090-050 H25

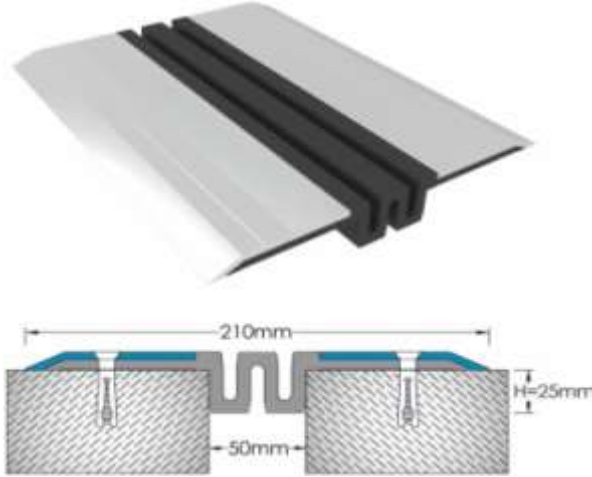

Teknik Özellikler / Technical Features

Dilatasyon Derz Açıklığı / Gap	50 mm
Yükseklik / Height	25 mm
Yüzey Genişliği / Surface Width	210 mm
Hareket Kapasitesi / Movement Capacity	± 25 mm
5 ton FORKLİFT, 9 ton KAMYON yüküne dayanıklıdır Resistan to the 5 tons FORKLIFT and 9 tons TRUCK load	

ZU 4250-050 H35

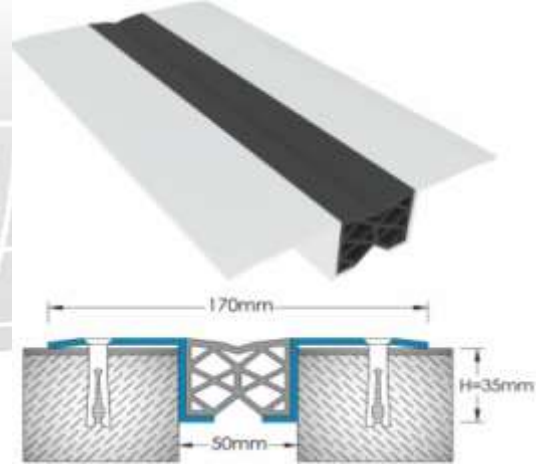

Teknik Özellikler / Technical Features

Dilatasyon Derz Açıklığı / Gap	50 mm
Yükseklik / Height	35 mm
Yüzey Genişliği / Surface Width	170 mm
Hareket Kapasitesi / Movement Capacity	± 25 mm
Hafif araç trafiğine dayanıklıdır / Resistant for light vehicle traffic	



KAFES GROUP
Ostim Osb Mh. 1568 Cd. No:51
06374 Yenimahalle/Ankara/Turkey
Tel.:+90 (0) 535 248 97 85
WEB.: www.kafesgroup.com
EMAIL.: info@kafesgroup.com

KAFES GROUP PROFILE SYSTEMS

8cm Açıklık İçin Duvar-Tavan Dilatasyon Profilleri Wall-Ceiling Expansion Joint Profiles For 8cm Gaps

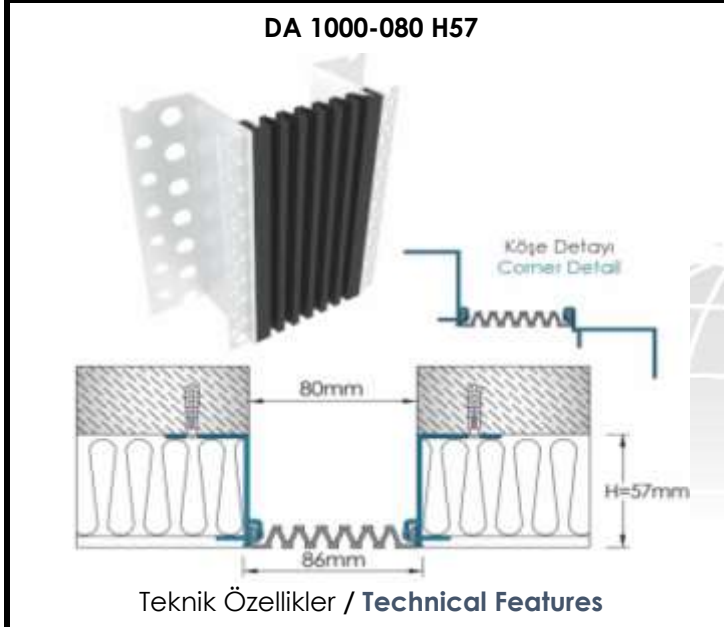

Dilatasyon Derz Açıklığı / Gap	80 mm
Yükseklik / Height	57 mm
Yüzey Genişliği / Surface Width	86 mm
Hareket Kapasitesi / Movement Capacity	± 35 mm

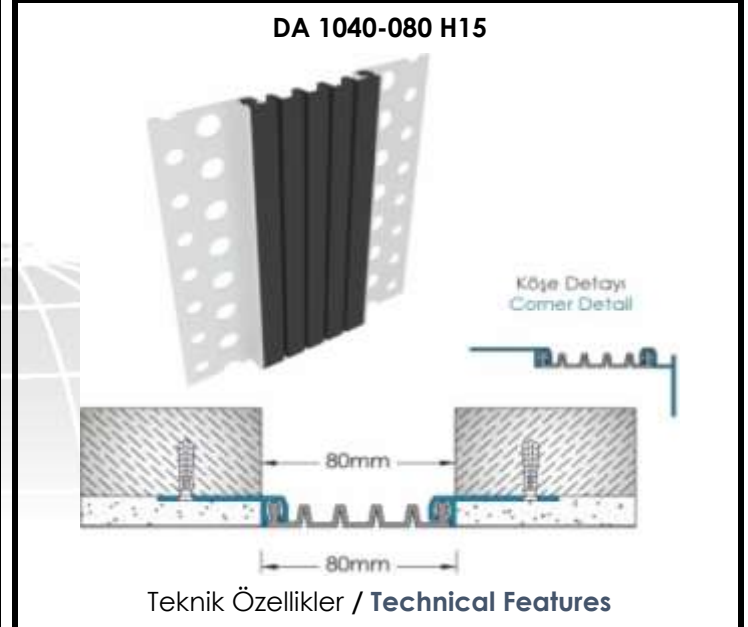

Dilatasyon Derz Açıklığı / Gap	80 mm
Yükseklik / Height	15 mm
Yüzey Genişliği / Surface Width	80 mm
Hareket Kapasitesi / Movement Capacity	± 20 mm

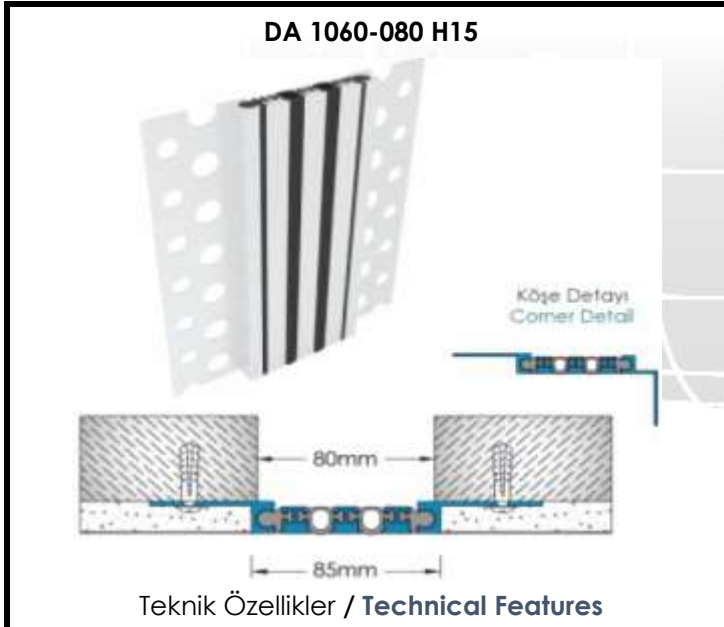

Dilatasyon Derz Açıklığı / Gap	80 mm
Yükseklik / Height	15 mm
Yüzey Genişliği / Surface Width	85 mm
Hareket Kapasitesi / Movement Capacity	± 12 mm

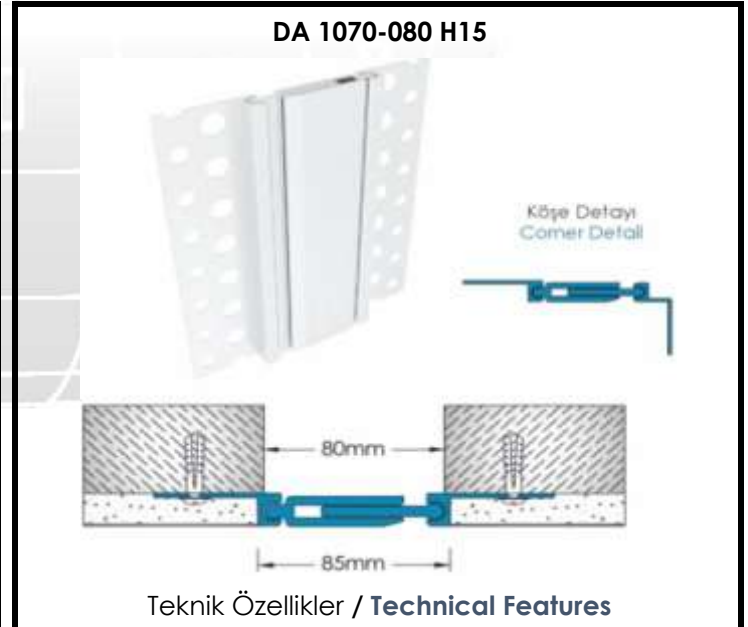

Dilatasyon Derz Açıklığı / Gap	80 mm
Yükseklik / Height	15 mm
Yüzey Genişliği / Surface Width	85 mm
Hareket Kapasitesi / Movement Capacity	± 12 mm



KAFES GROUP
Ostim Osb Mh. 1568 Cd. No:51
06374 Yenimahalle/Ankara/Turkey
Tel.:+90 (0) 535 248 97 85
WEB.: www.kafesgroup.com
EMAIL.: info@kafesgroup.com

KAFES GROUP PROFILE SYSTEMS

8cm Açıklık İçin Duvar-Tavan Dilatasyon Profilleri Wall-Ceiling Expansion Joint Profiles For 8cm Gaps

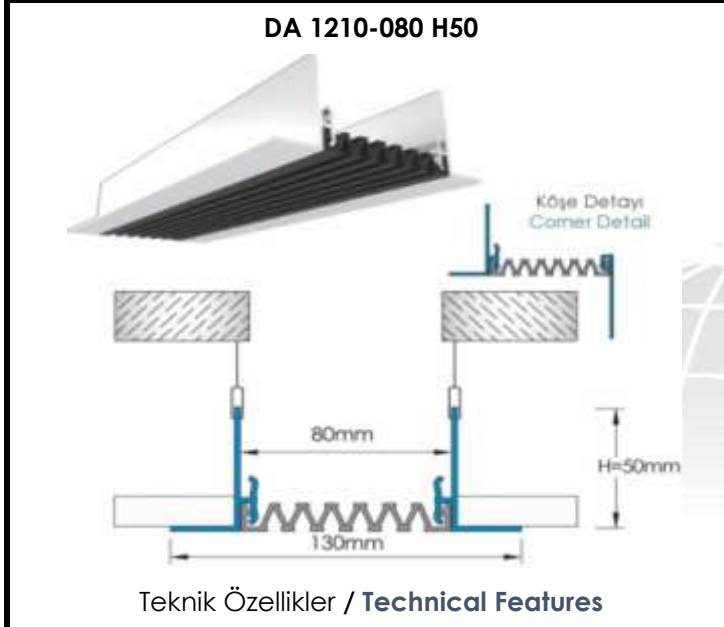

Dilatasyon Derz Açıklığı / Gap	80 mm
Yükseklik / Height	50 mm
Yüzey Genişliği / Surface Width	130 mm
Hareket Kapasitesi / Movement Capacity	± 35 mm

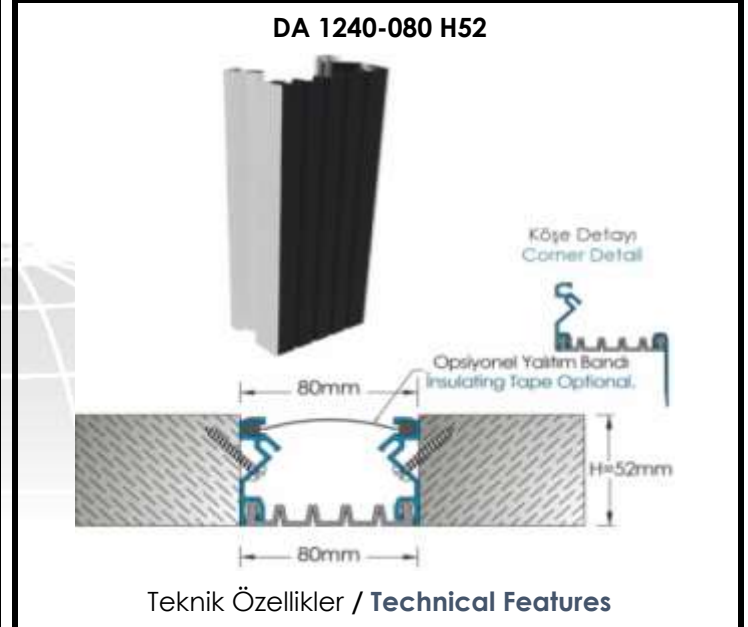

Dilatasyon Derz Açıklığı / Gap	80 mm
Yükseklik / Height	52 mm
Yüzey Genişliği / Surface Width	80 mm
Hareket Kapasitesi / Movement Capacity	± 20 mm

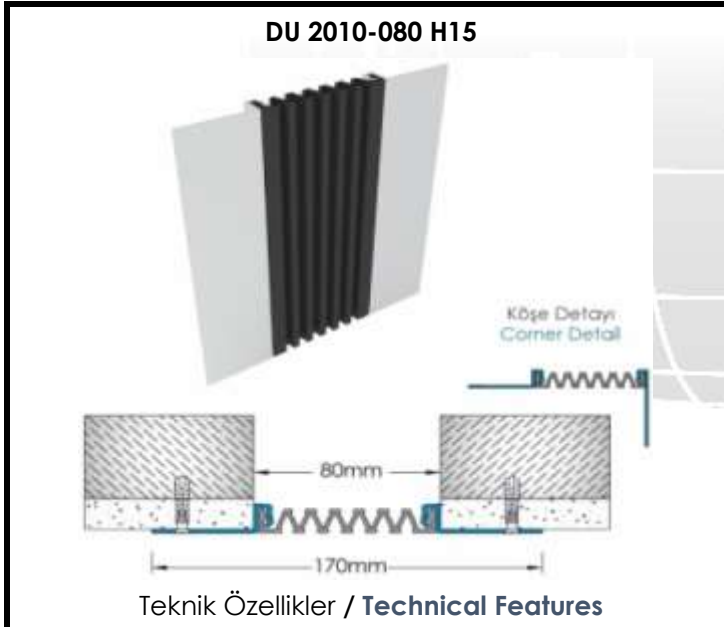

Dilatasyon Derz Açıklığı / Gap	80 mm
Yükseklik / Height	15 mm
Yüzey Genişliği / Surface Width	170 mm
Hareket Kapasitesi / Movement Capacity	± 35 mm

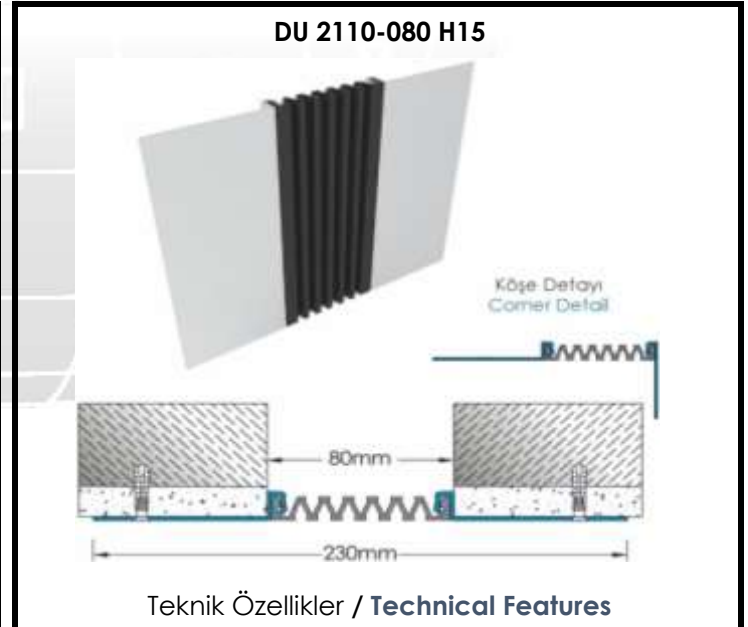

Dilatasyon Derz Açıklığı / Gap	80 mm
Yükseklik / Height	15 mm
Yüzey Genişliği / Surface Width	230 mm
Hareket Kapasitesi / Movement Capacity	± 35 mm



KAFES GROUP
Ostim Osb Mh. 1568 Cd. No:51
06374 Yenimahalle/Ankara/Turkey
Tel.:+90 (0) 535 248 97 85
WEB.: www.kafesgroup.com
EMAIL.: info@kafesgroup.com

KAFES GROUP PROFILE SYSTEMS

8cm Açıklık İçin Duvar-Tavan Dilatasyon Profilleri Wall-Ceiling Expansion Joint Profiles For 8cm Gaps

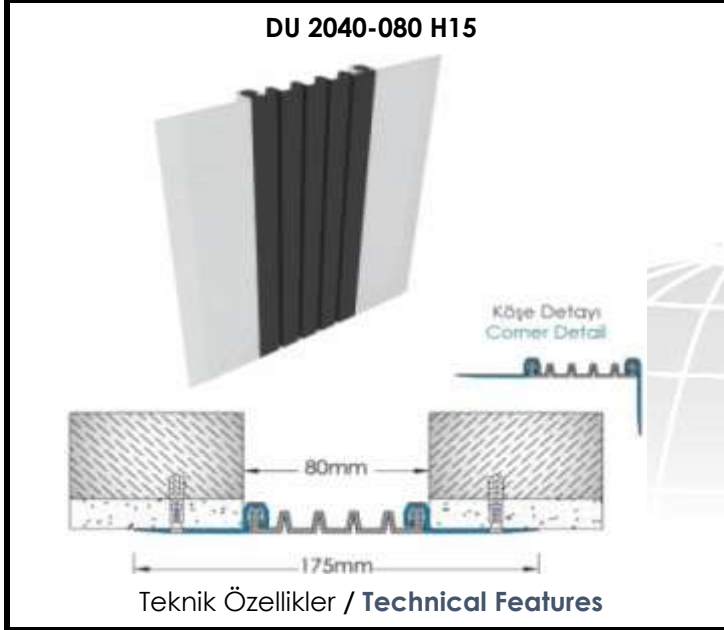

Dilatasyon Derz Açıklığı / Gap	80 mm
Yükseklik / Height	15 mm
Yüzey Genişliği / Surface Width	175 mm
Hareket Kapasitesi / Movement Capacity	± 20 mm

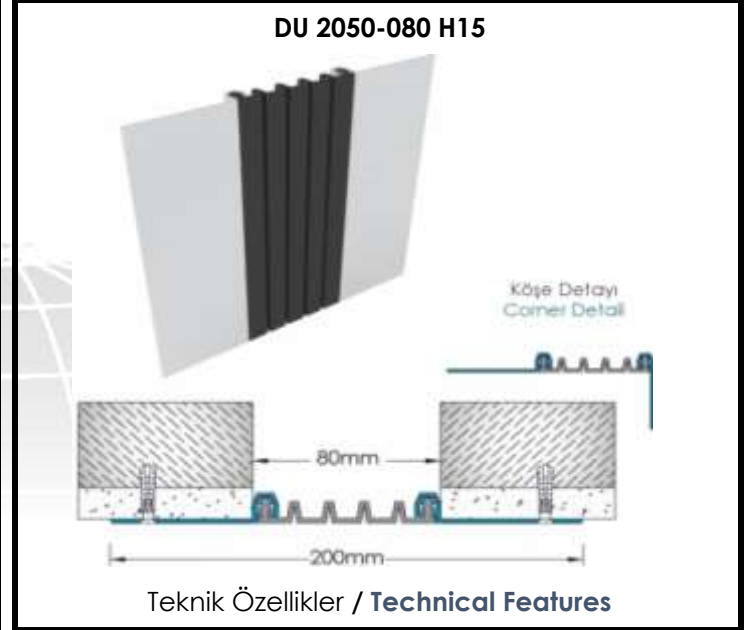

Dilatasyon Derz Açıklığı / Gap	80 mm
Yükseklik / Height	15 mm
Yüzey Genişliği / Surface Width	200 mm
Hareket Kapasitesi / Movement Capacity	± 20 mm

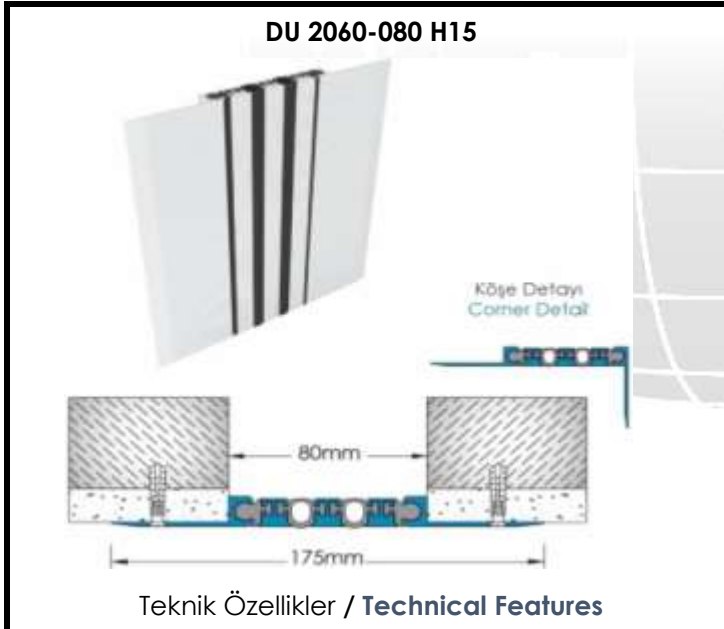

Dilatasyon Derz Açıklığı / Gap	80 mm
Yükseklik / Height	15 mm
Yüzey Genişliği / Surface Width	175 mm
Hareket Kapasitesi / Movement Capacity	± 12 mm

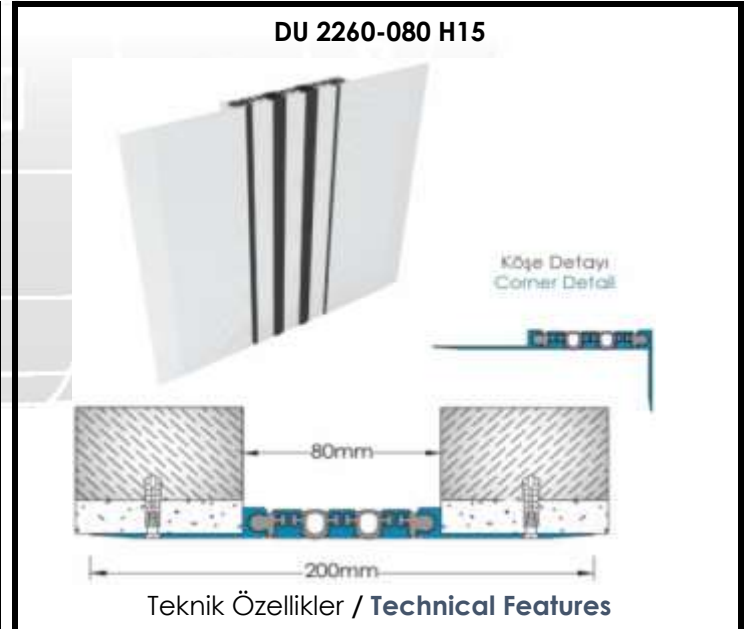

Dilatasyon Derz Açıklığı / Gap	80 mm
Yükseklik / Height	15 mm
Yüzey Genişliği / Surface Width	200 mm
Hareket Kapasitesi / Movement Capacity	± 12 mm



KAFES GROUP
Ostim Osb Mh. 1568 Cd. No:51
06374 Yenimahalle/Ankara/Turkey
Tel.:+90 (0) 535 248 97 85
WEB.: www.kafesgroup.com
EMAIL.: info@kafesgroup.com

KAFES GROUP PROFILE SYSTEMS

8cm Açıklık İçin Duvar-Tavan Dilatasyon Profilleri Wall-Ceiling Expansion Joint Profiles For 8cm Gaps

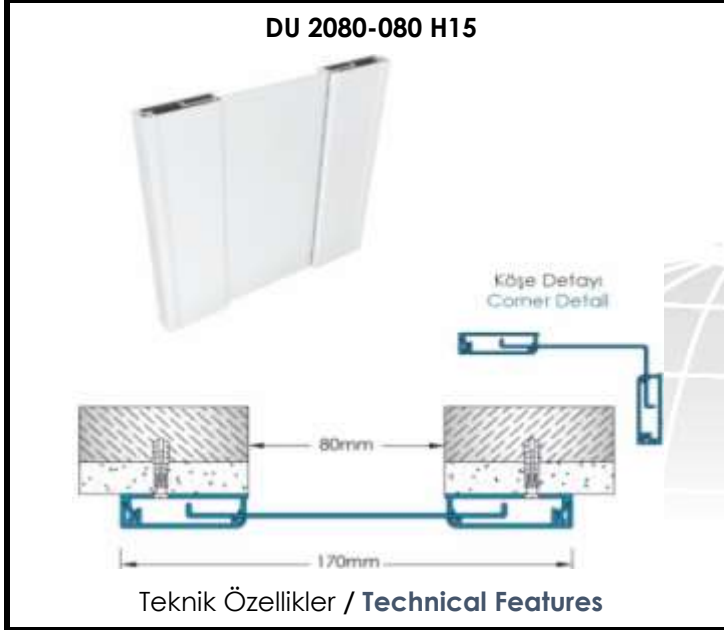

Dilatasyon Derz Açıklığı / Gap	80 mm
Yükseklik / Height	15 mm
Yüzey Genişliği / Surface Width	170 mm
Hareket Kapasitesi / Movement Capacity	± 45 mm

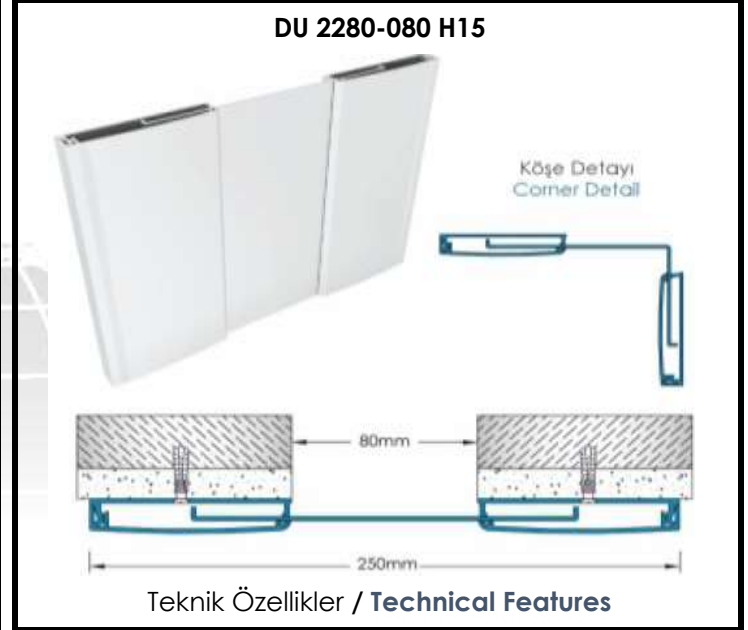

Dilatasyon Derz Açıklığı / Gap	80 mm
Yükseklik / Height	15 mm
Yüzey Genişliği / Surface Width	250 mm
Hareket Kapasitesi / Movement Capacity	± 65 mm

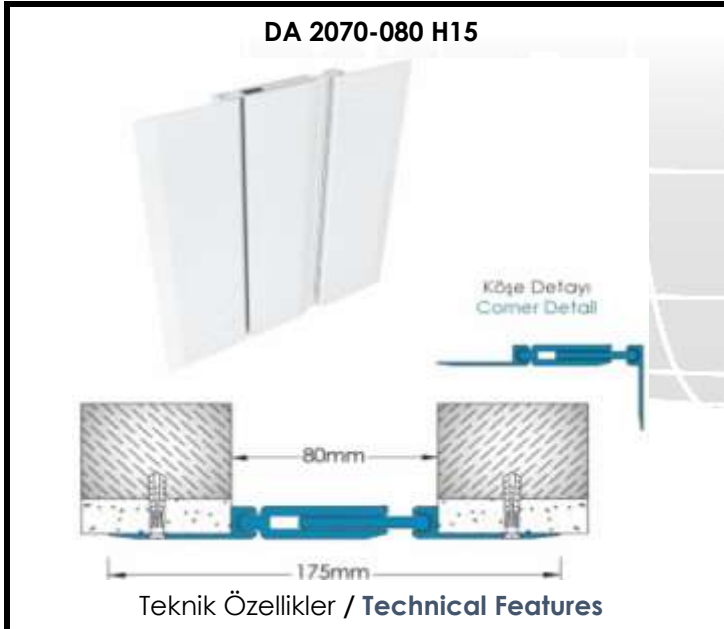

Dilatasyon Derz Açıklığı / Gap	80 mm
Yükseklik / Height	15 mm
Yüzey Genişliği / Surface Width	175 mm
Hareket Kapasitesi / Movement Capacity	± 12 mm

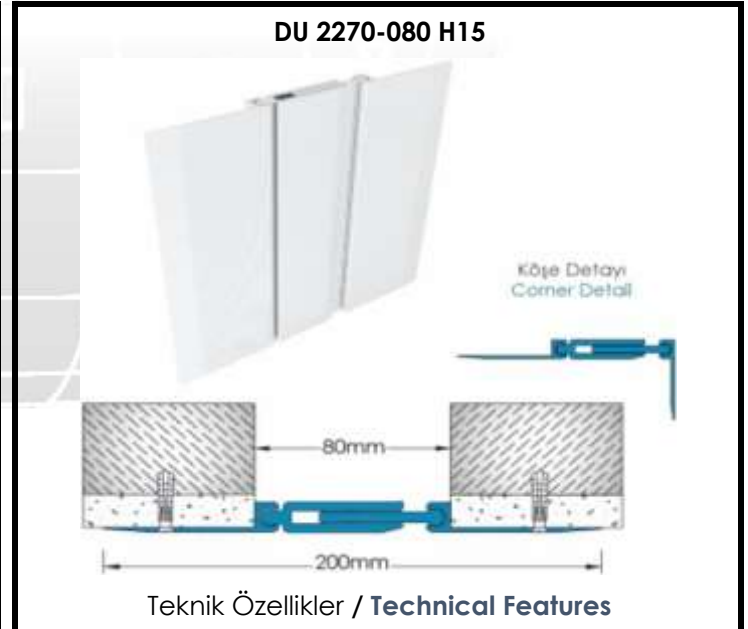

Dilatasyon Derz Açıklığı / Gap	80 mm
Yükseklik / Height	15 mm
Yüzey Genişliği / Surface Width	200 mm
Hareket Kapasitesi / Movement Capacity	± 12 mm



KAFES GROUP
Ostim Osb Mh. 1568 Cd. No:51
06374 Yenimahalle/Ankara/Turkey
Tel.:+90 (0) 535 248 97 85
WEB.: www.kafesgroup.com
EMAIL.: info@kafesgroup.com

KAFES GROUP PROFILE SYSTEMS

8cm Açıklık İçin Zemin Dilatasyon Profilleri Floor Expansion Joint Profiles For 3cm Gaps

ZA 3030-080 H50

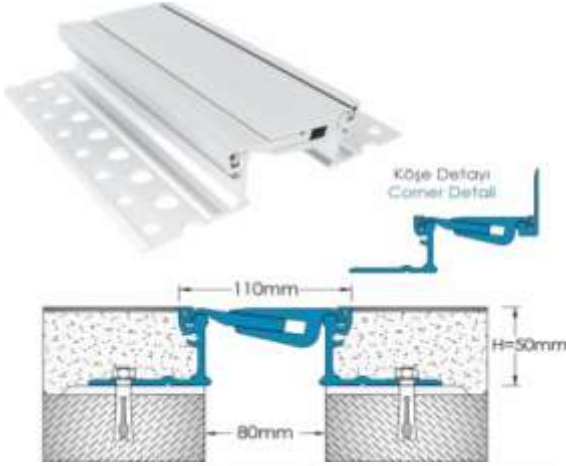

Teknik Özellikler / Technical Features

Dilatasyon Derz Açıklığı / Gap	80 mm
Yükseklik / Height	50 mm
Yüzey Genişliği / Surface Width	110 mm
Hareket Kapasitesi / Movement Capacity	± 16 mm
6,5 ton FORKLİFT, 30 ton KAMYON yüküne dayanıklıdır Resistan to the 6,5 tons FORKLIFT and 30 tons TRUCK load	

ZA 3030-080 H70

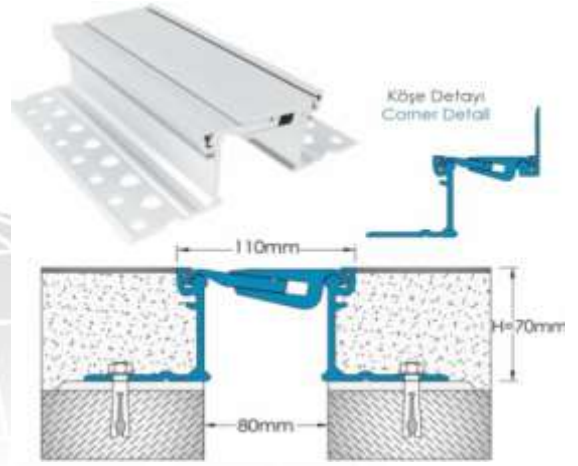

Teknik Özellikler / Technical Features

Dilatasyon Derz Açıklığı / Gap	80 mm
Yükseklik / Height	70 mm
Yüzey Genişliği / Surface Width	110 mm
Hareket Kapasitesi / Movement Capacity	± 16 mm
6,5 ton FORKLİFT, 30 ton KAMYON yüküne dayanıklıdır Resistan to the 6,5 tons FORKLIFT and 30 tons TRUCK load	

ZA 3070-080 H28

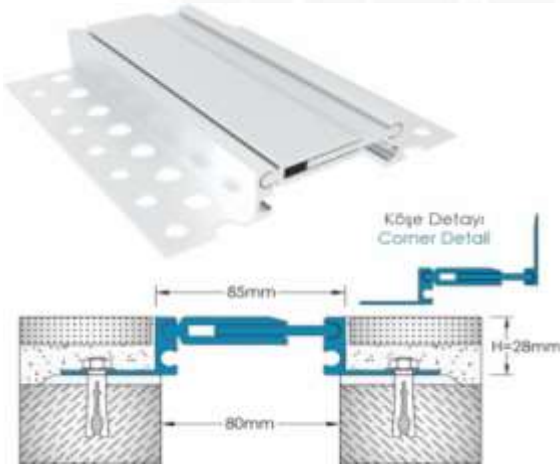

Teknik Özellikler / Technical Features

Dilatasyon Derz Açıklığı / Gap	80 mm
Yükseklik / Height	28 mm
Yüzey Genişliği / Surface Width	85 mm
Hareket Kapasitesi / Movement Capacity	± 12 mm
Hafif araç trafiğine dayanıklıdır / Resistant for light vehicle traffic	

ZA 3070-080 H43

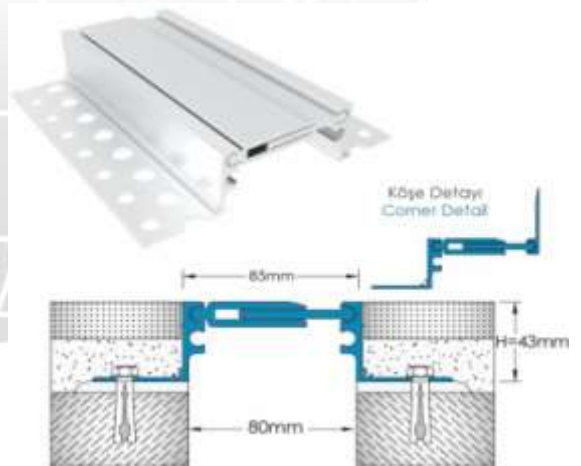

Teknik Özellikler / Technical Features

Dilatasyon Derz Açıklığı / Gap	80 mm
Yükseklik / Height	43 mm
Yüzey Genişliği / Surface Width	85 mm
Hareket Kapasitesi / Movement Capacity	± 12 mm
2,5 ton FORKLİFT, 6 ton KAMYON yüküne dayanıklıdır Resistan to the 2,5 tons FORKLIFT and 6 tons TRUCK load	



KAFES GROUP
Ostim Osb Mh. 1568 Cd. No:51
06374 Yenimahalle/Ankara/Turkey
Tel.:+90 (0) 535 248 97 85
WEB.: www.kafesgroup.com
EMAIL.: info@kafesgroup.com

KAFES GROUP PROFILE SYSTEMS

8cm Açıklık İçin Zemin Dilatasyon Profilleri Floor Expansion Joint Profiles For 3cm Gaps

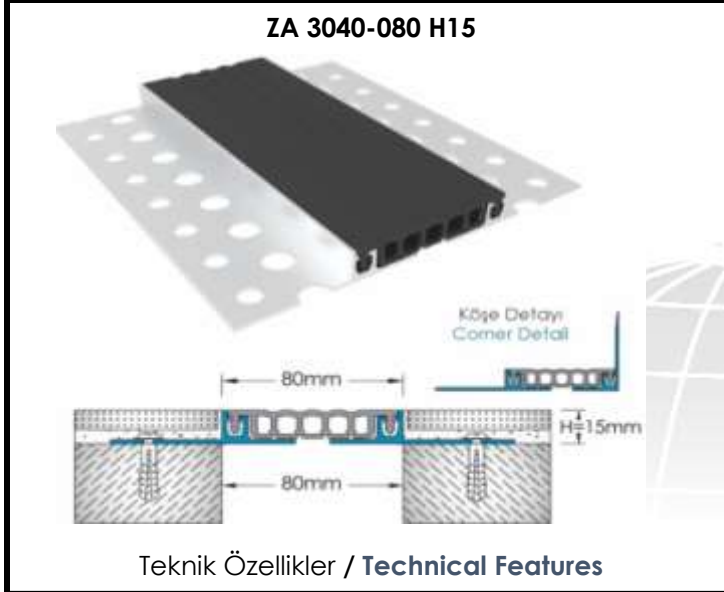

Dilatasyon Derz Açıklığı / Gap	80 mm
Yükseklik / Height	15 mm
Yüzey Genişliği / Surface Width	80 mm
Hareket Kapasitesi / Movement Capacity	± 10 mm
Yaya trafiğine dayanıklıdır / Resistant for pedestrian traffic	

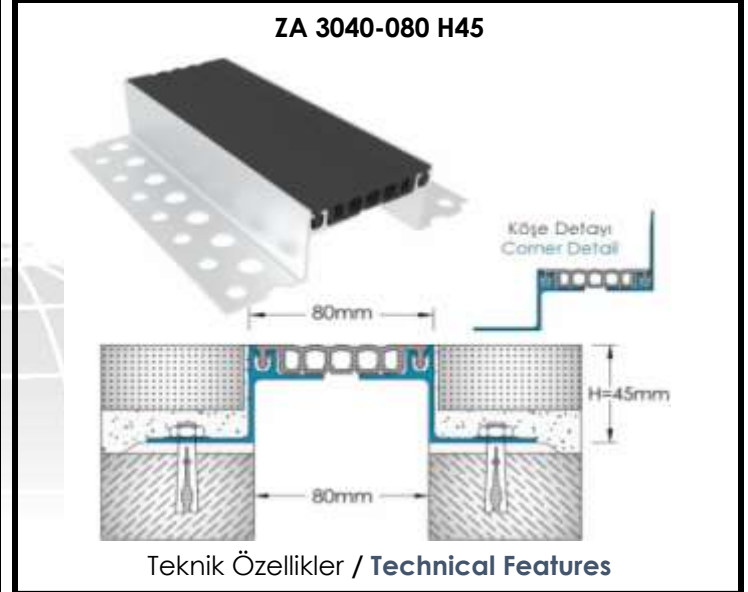

Dilatasyon Derz Açıklığı / Gap	80 mm
Yükseklik / Height	45 mm
Yüzey Genişliği / Surface Width	80 mm
Hareket Kapasitesi / Movement Capacity	± 10 mm
Yaya trafiğine dayanıklıdır / Resistant for pedestrian traffic	



Dilatasyon Derz Açıklığı / Gap	80 mm
Yükseklik / Height	23 mm
Yüzey Genişliği / Surface Width	90 mm
Hareket Kapasitesi / Movement Capacity	± 12 mm
Hafif araç trafiğine dayanıklıdır / Resistant for light vehicle traffic	

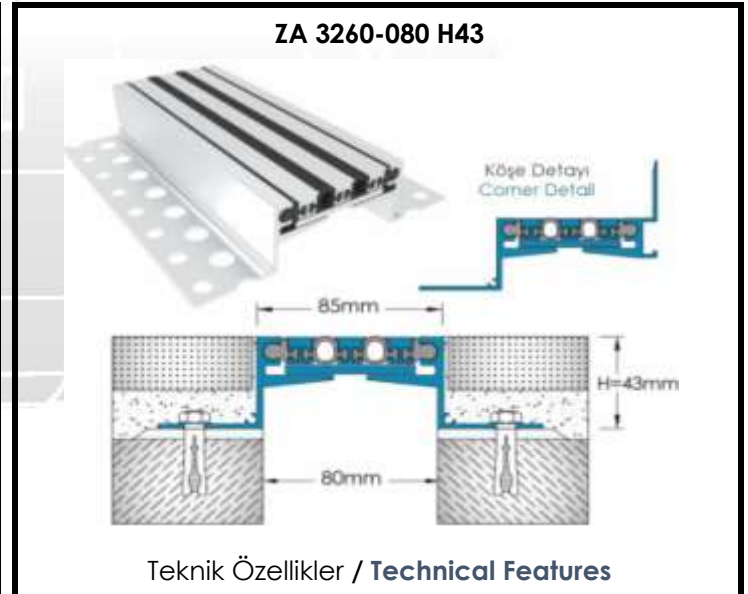

Dilatasyon Derz Açıklığı / Gap	80 mm
Yükseklik / Height	43 mm
Yüzey Genişliği / Surface Width	85 mm
Hareket Kapasitesi / Movement Capacity	± 12 mm
Hafif araç trafiğine dayanıklıdır / Resistant for light vehicle traffic	



KAFES GROUP
Ostim Osb Mh. 1568 Cd. No:51
06374 Yenimahalle/Ankara/Turkey
Tel.:+90 (0) 535 248 97 85
WEB.: www.kafesgroup.com
EMAIL.: info@kafesgroup.com

KAFES GROUP PROFILE SYSTEMS

8cm Açıklık İçin Zemin Dilatasyon Profilleri Floor Expansion Joint Profiles For 3cm Gaps

ZU 4030-080 H14

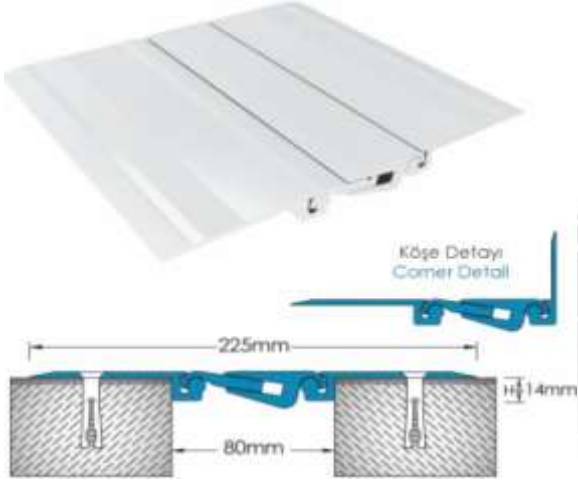

Teknik Özellikler / Technical Features

Dilatasyon Derz Açıklığı / Gap	80 mm
Yükseklik / Height	14 mm
Yüzey Genişliği / Surface Width	225 mm
Hareket Kapasitesi / Movement Capacity	± 10 mm
3,5 ton FORKLİFT, 9 ton KAMYON yüküne dayanıklıdır Resistan to the 3,5 tons FORKLIFT and 9 tons TRUCK load	

ZU 4130-080 H14

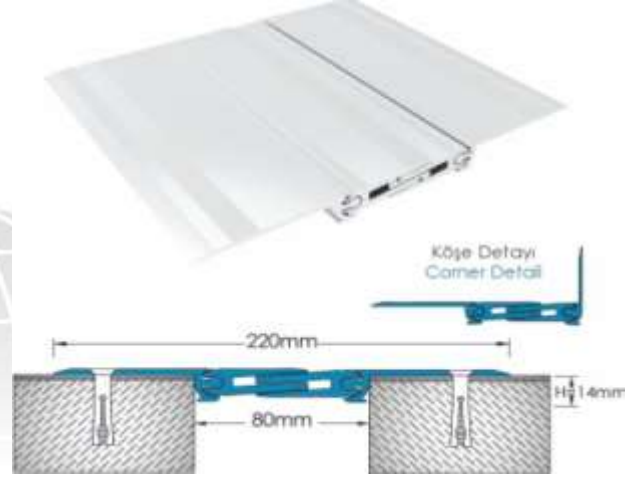

Teknik Özellikler / Technical Features

Dilatasyon Derz Açıklığı / Gap	80 mm
Yükseklik / Height	14 mm
Yüzey Genişliği / Surface Width	220 mm
Hareket Kapasitesi / Movement Capacity	± 10 mm
3,5 ton FORKLİFT, 9 ton KAMYON yüküne dayanıklıdır Resistan to the 3,5 tons FORKLIFT and 9 tons TRUCK load	

ZU 4040-080 H15

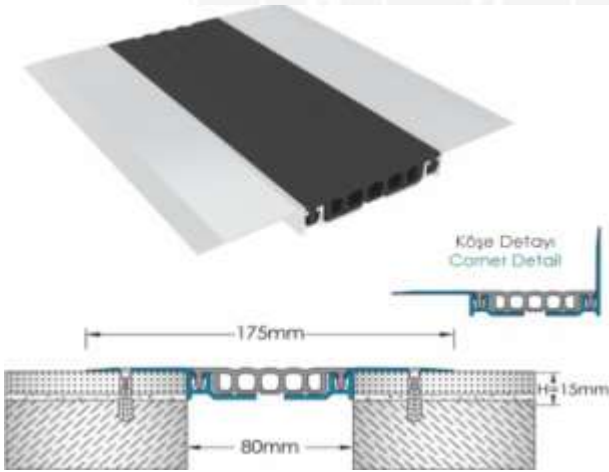

Teknik Özellikler / Technical Features

Dilatasyon Derz Açıklığı / Gap	80 mm
Yükseklik / Height	15 mm
Yüzey Genişliği / Surface Width	175 mm
Hareket Kapasitesi / Movement Capacity	± 10 mm
Yaya trafiğine dayanıklıdır / Resistant for pedestrian traffic	

ZU 4040-080 H30

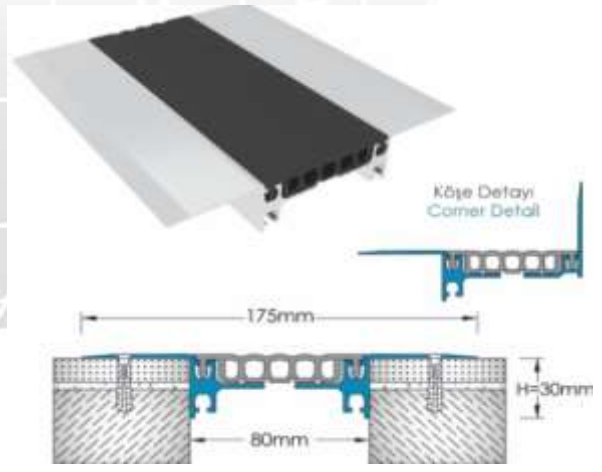

Teknik Özellikler / Technical Features

Dilatasyon Derz Açıklığı / Gap	80 mm
Yükseklik / Height	30 mm
Yüzey Genişliği / Surface Width	175 mm
Hareket Kapasitesi / Movement Capacity	± 10 mm
Yaya trafiğine dayanıklıdır / Resistant for pedestrian traffic	



KAFES GROUP
Ostim Osb Mh. 1568 Cd. No:51
06374 Yenimahalle/Ankara/Turkey
Tel.:+90 (0) 535 248 97 85
WEB.: www.kafesgroup.com
EMAIL.: info@kafesgroup.com

KAFES GROUP PROFILE SYSTEMS

8cm Açıklık İçin Zemin Dilatasyon Profilleri Floor Expansion Joint Profiles For 3cm Gaps

ZU 4060-080 H23

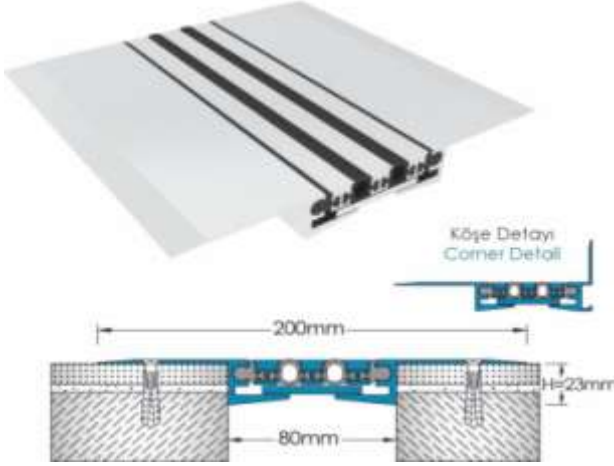

Teknik Özellikler / Technical Features

Dilatasyon Derz Açıklığı / Gap	80 mm
Yükseklik / Height	23 mm
Yüzey Genişliği / Surface Width	200 mm
Hareket Kapasitesi / Movement Capacity	± 12 mm
Hafif araç trafiğine dayanıklıdır / Resistant for light vehicle traffic	

ZU 4070-080 H28

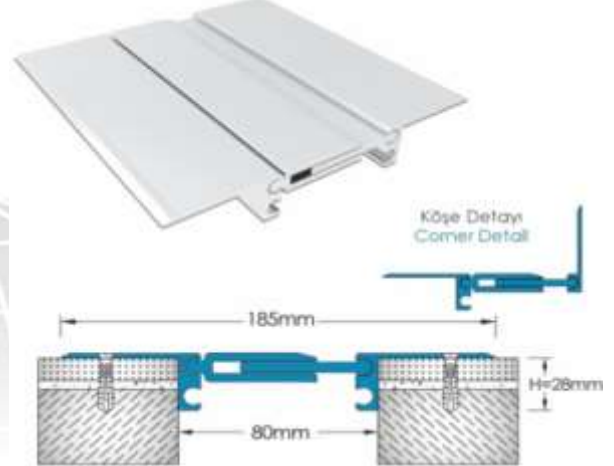

Teknik Özellikler / Technical Features

Dilatasyon Derz Açıklığı / Gap	80 mm
Yükseklik / Height	28 mm
Yüzey Genişliği / Surface Width	185 mm
Hareket Kapasitesi / Movement Capacity	± 12 mm
Hafif araç trafiğine dayanıklıdır / Resistant for light vehicle traffic	

ZU 4080-080 H30

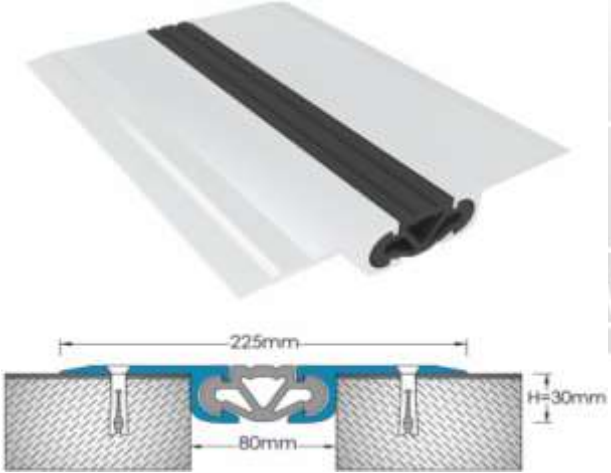

Teknik Özellikler / Technical Features

Dilatasyon Derz Açıklığı / Gap	80 mm
Yükseklik / Height	30 mm
Yüzey Genişliği / Surface Width	225 mm
Hareket Kapasitesi / Movement Capacity	± 10 mm
3,5 ton FORKLİFT, 30 ton KAMYON yüküne dayanıklıdır Resistan to the 3,5 tons FORKLIFT and 30 tons TRUCK load	

ZU 4090-080 H50

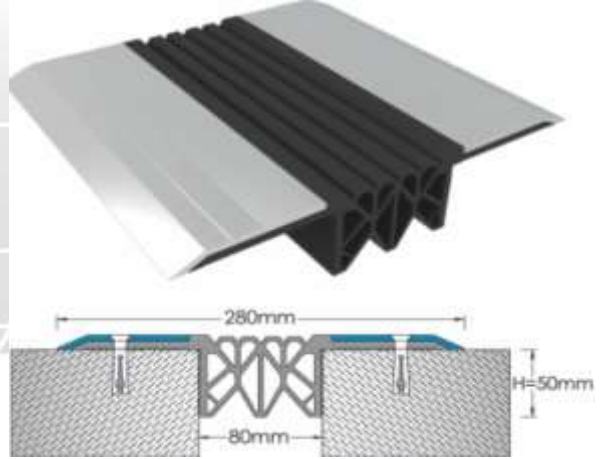

Teknik Özellikler / Technical Features

Dilatasyon Derz Açıklığı / Gap	80 mm
Yükseklik / Height	50 mm
Yüzey Genişliği / Surface Width	280 mm
Hareket Kapasitesi / Movement Capacity	± 30 mm
3,5 ton FORKLİFT, 9 ton KAMYON yüküne dayanıklıdır Resistan to the 3,5 tons FORKLIFT and 9 tons TRUCK load	



KAFES GROUP
Ostim Osb Mh. 1568 Cd. No:51
06374 Yenimahalle/Ankara/Turkey
Tel.:+90 (0) 535 248 97 85
WEB.: www.kafesgroup.com
EMAIL.: info@kafesgroup.com

KAFES GROUP PROFILE SYSTEMS

10cm Açıklık İçin Duvar-Tavan Dilatasyon Profilleri Wall-Ceiling Expansion Joint Profiles For 10cm Gaps

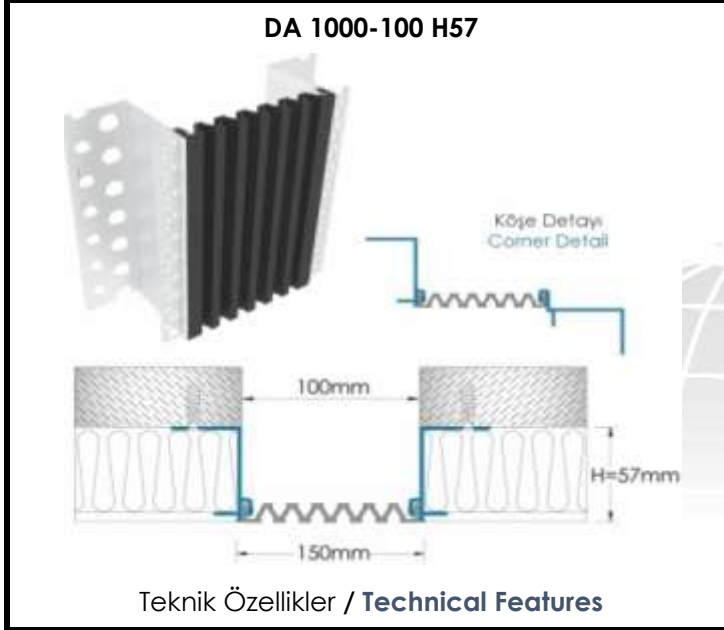

Dilatasyon Derz Açıklığı / Gap	100 mm
Yükseklik / Height	57 mm
Yüzey Genişliği / Surface Width	150 mm
Hareket Kapasitesi / Movement Capacity	± 50 mm

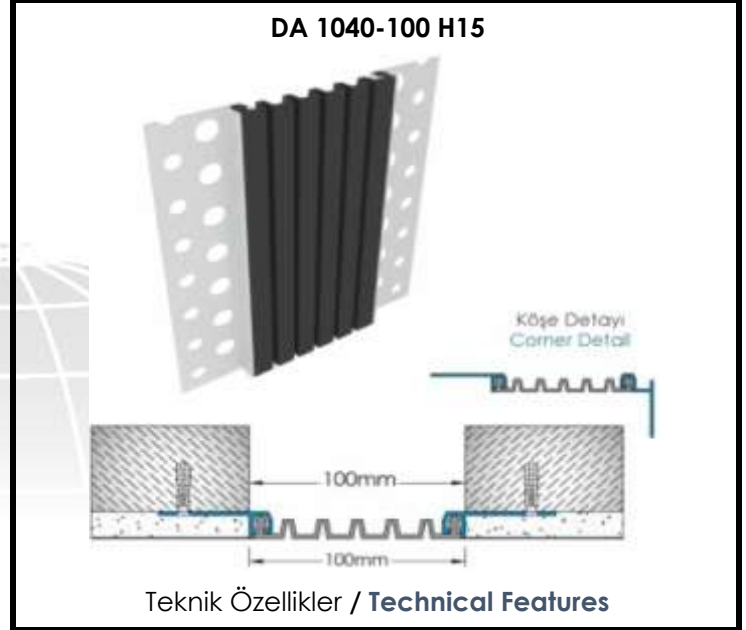

Dilatasyon Derz Açıklığı / Gap	100 mm
Yükseklik / Height	15 mm
Yüzey Genişliği / Surface Width	100 mm
Hareket Kapasitesi / Movement Capacity	+ 30/-20 mm

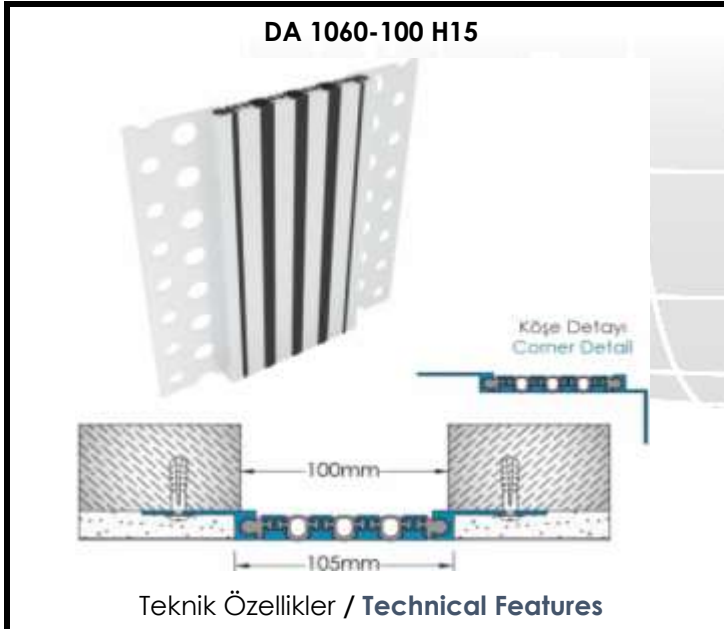

Dilatasyon Derz Açıklığı / Gap	100 mm
Yükseklik / Height	15 mm
Yüzey Genişliği / Surface Width	105 mm
Hareket Kapasitesi / Movement Capacity	± 15 mm

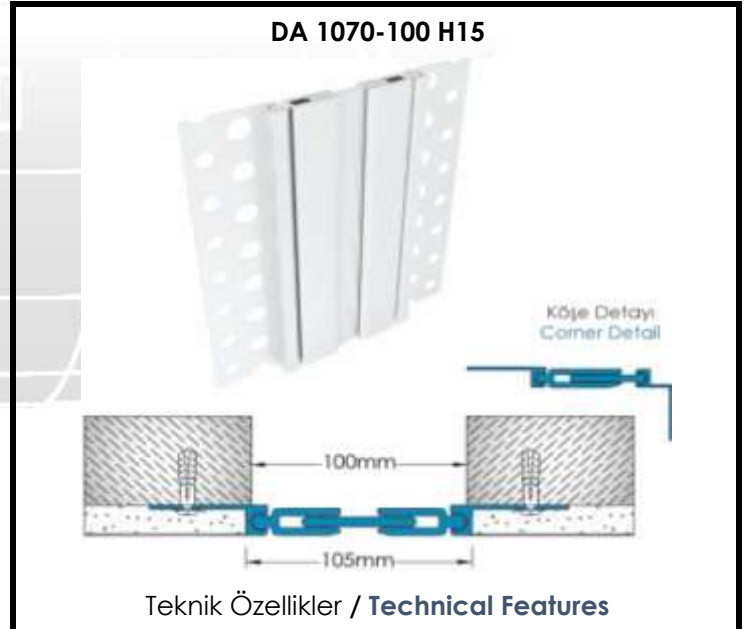

Dilatasyon Derz Açıklığı / Gap	100 mm
Yükseklik / Height	15 mm
Yüzey Genişliği / Surface Width	105 mm
Hareket Kapasitesi / Movement Capacity	± 15 mm



KAFES GROUP
Ostim Osb Mh. 1568 Cd. No:51
06374 Yenimahalle/Ankara/Turkey
Tel.:+90 (0) 535 248 97 85
WEB.: www.kafesgroup.com
EMAIL.: info@kafesgroup.com

KAFES GROUP PROFILE SYSTEMS

10cm Açıklık İçin Duvar-Tavan Dilatasyon Profilleri Wall-Ceiling Expansion Joint Profiles For 10cm Gaps

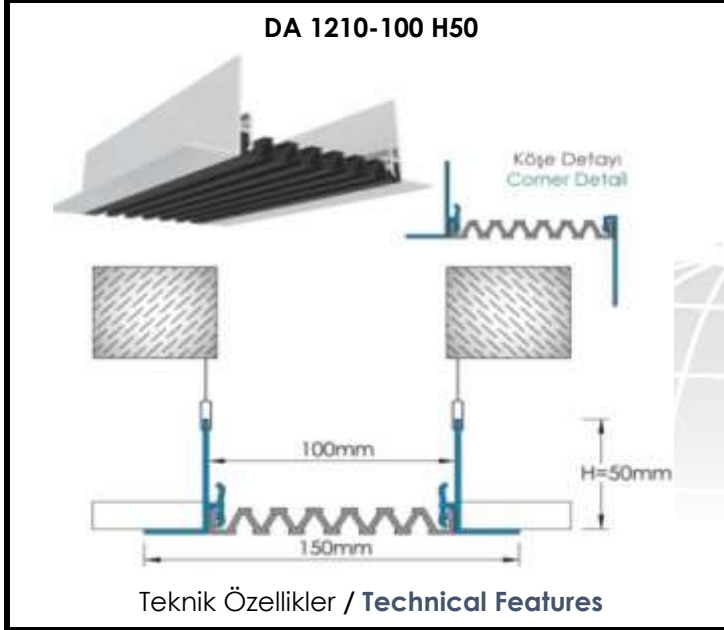

Dilatasyon Derz Açıklığı / Gap	100 mm
Yükseklik / Height	50 mm
Yüzey Genişliği / Surface Width	150 mm
Hareket Kapasitesi / Movement Capacity	± 50 mm

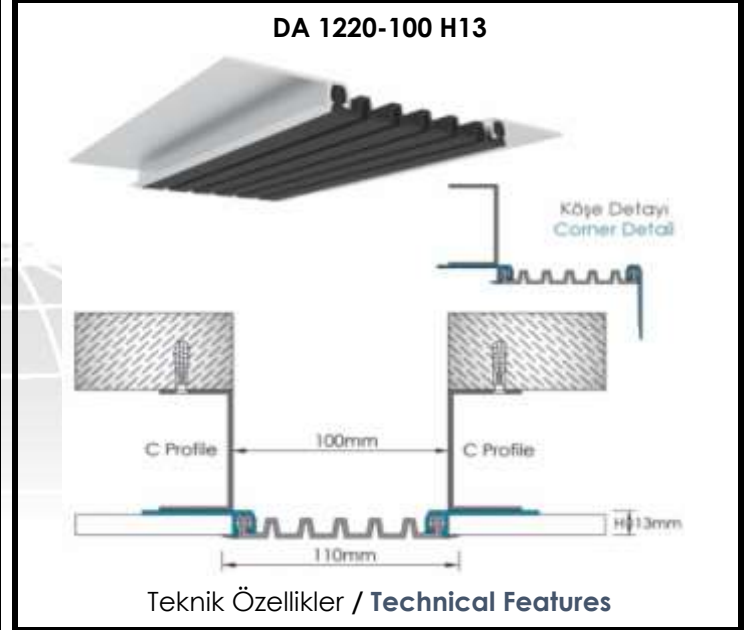

Dilatasyon Derz Açıklığı / Gap	100 mm
Yükseklik / Height	13 mm
Yüzey Genişliği / Surface Width	110 mm
Hareket Kapasitesi / Movement Capacity	+ 30/-20 mm

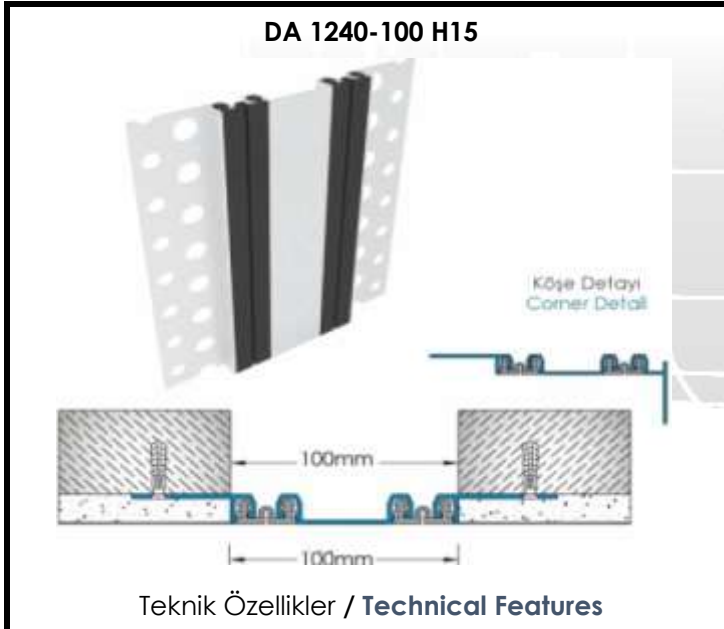

Dilatasyon Derz Açıklığı / Gap	100 mm
Yükseklik / Height	15 mm
Yüzey Genişliği / Surface Width	100 mm
Hareket Kapasitesi / Movement Capacity	± 50 mm

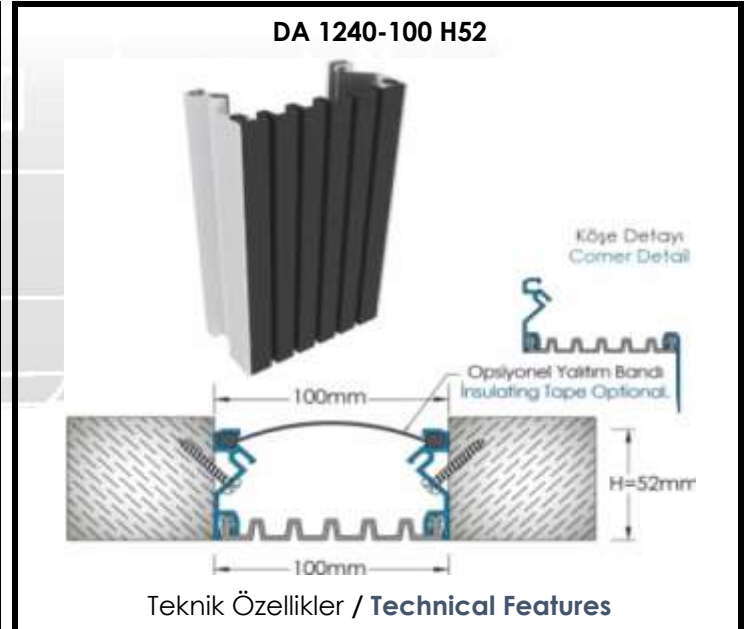

Dilatasyon Derz Açıklığı / Gap	100 mm
Yükseklik / Height	52 mm
Yüzey Genişliği / Surface Width	100 mm
Hareket Kapasitesi / Movement Capacity	± 50 mm



KAFES GROUP
Ostim Osb Mh. 1568 Cd. No:51
06374 Yenimahalle/Ankara/Turkey
Tel.:+90 (0) 535 248 97 85
WEB.: www.kafesgroup.com
EMAIL.: info@kafesgroup.com

KAFES GROUP PROFILE SYSTEMS

10cm Açıklık İçin Duvar-Tavan Dilatasyon Profilleri Wall-Ceiling Expansion Joint Profiles For 10cm Gaps

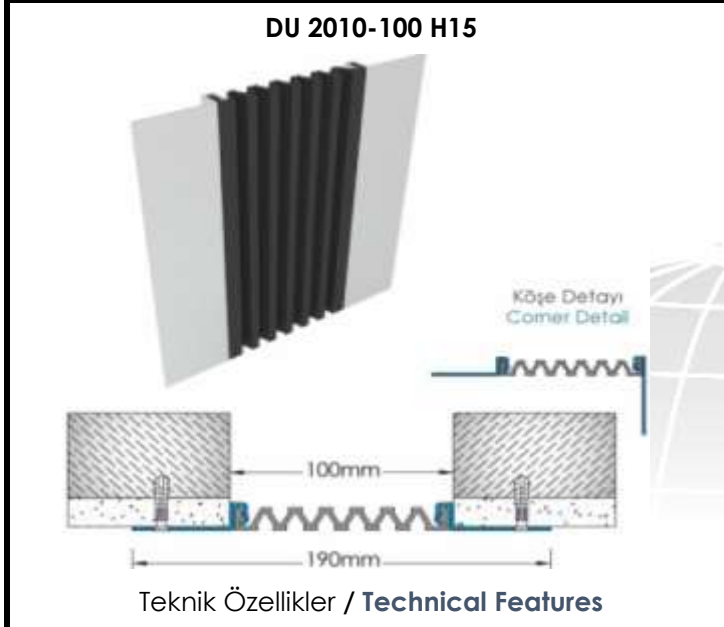

Dilatasyon Derz Açıklığı / Gap	100 mm
Yükseklik / Height	15 mm
Yüzey Genişliği / Surface Width	190 mm
Hareket Kapasitesi / Movement Capacity	± 50 mm

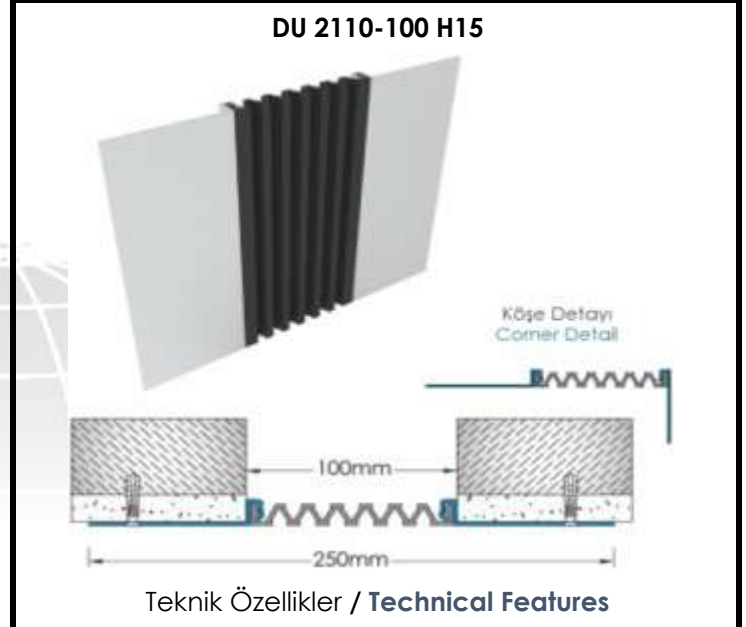

Dilatasyon Derz Açıklığı / Gap	100 mm
Yükseklik / Height	15 mm
Yüzey Genişliği / Surface Width	250 mm
Hareket Kapasitesi / Movement Capacity	± 50 mm

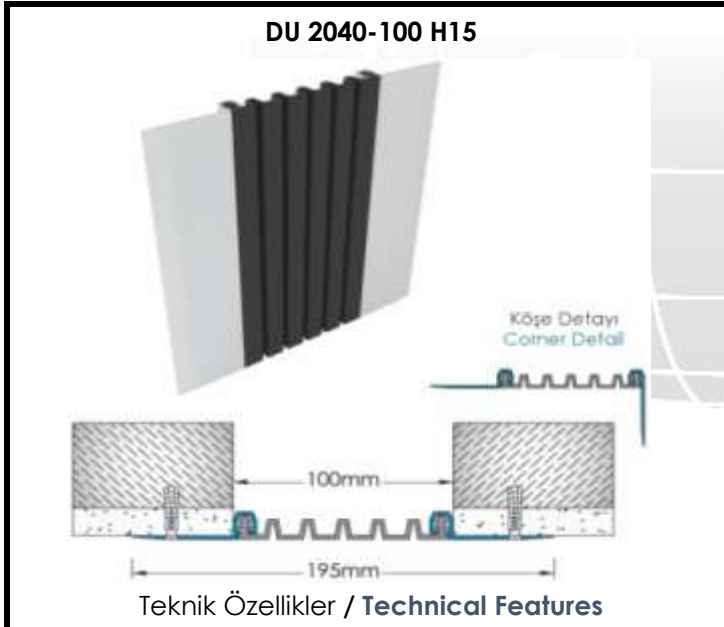

Dilatasyon Derz Açıklığı / Gap	100 mm
Yükseklik / Height	15 mm
Yüzey Genişliği / Surface Width	195 mm
Hareket Kapasitesi / Movement Capacity	+ 30/-20 mm

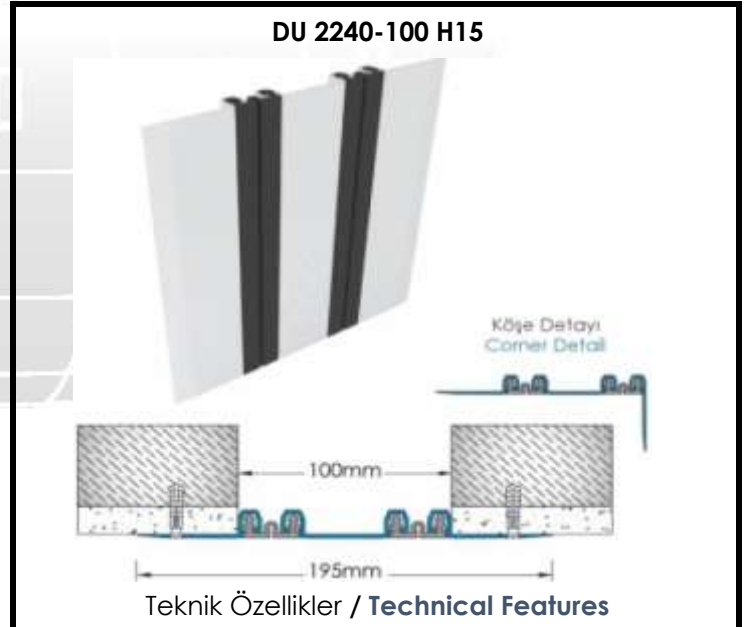

Dilatasyon Derz Açıklığı / Gap	100 mm
Yükseklik / Height	15 mm
Yüzey Genişliği / Surface Width	195 mm
Hareket Kapasitesi / Movement Capacity	± 14 mm



KAFES GROUP
Ostim Osb Mh. 1568 Cd. No:51
06374 Yenimahalle/Ankara/Turkey
Tel.:+90 (0) 535 248 97 85
WEB.: www.kafesgroup.com
EMAIL.: info@kafesgroup.com

KAFES GROUP PROFILE SYSTEMS

10cm Açıklık İçin Duvar-Tavan Dilatasyon Profilleri Wall-Ceiling Expansion Joint Profiles For 10cm Gaps

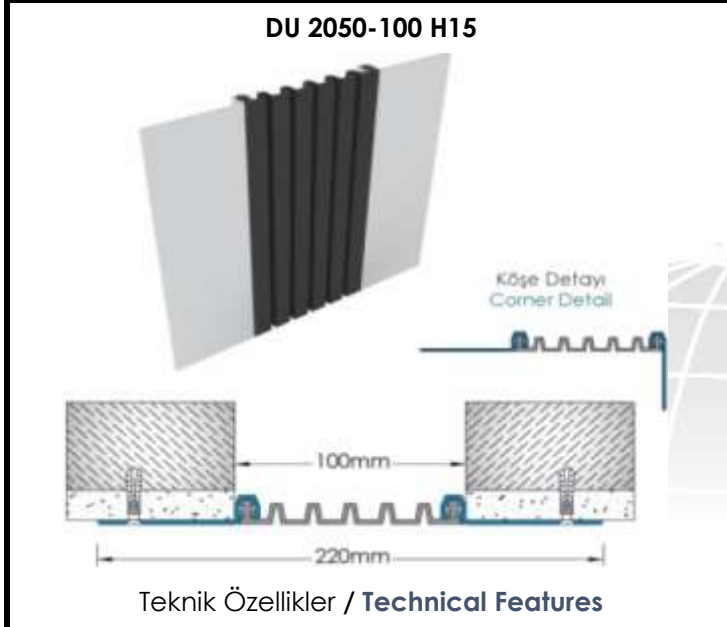

Dilatasyon Derz Açıklığı / Gap	100 mm
Yükseklik / Height	15 mm
Yüzey Genişliği / Surface Width	220 mm
Hareket Kapasitesi / Movement Capacity	+ 30/-20 mm

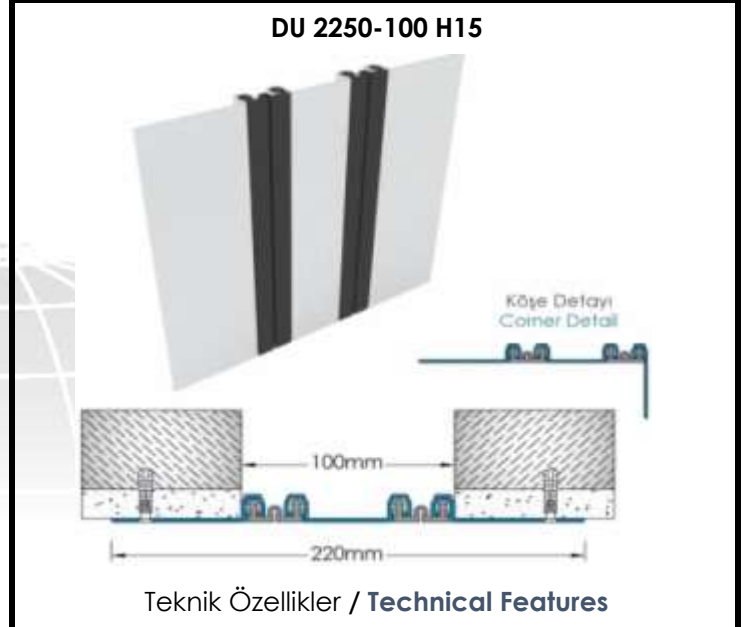

Dilatasyon Derz Açıklığı / Gap	100 mm
Yükseklik / Height	15 mm
Yüzey Genişliği / Surface Width	220 mm
Hareket Kapasitesi / Movement Capacity	± 14 mm

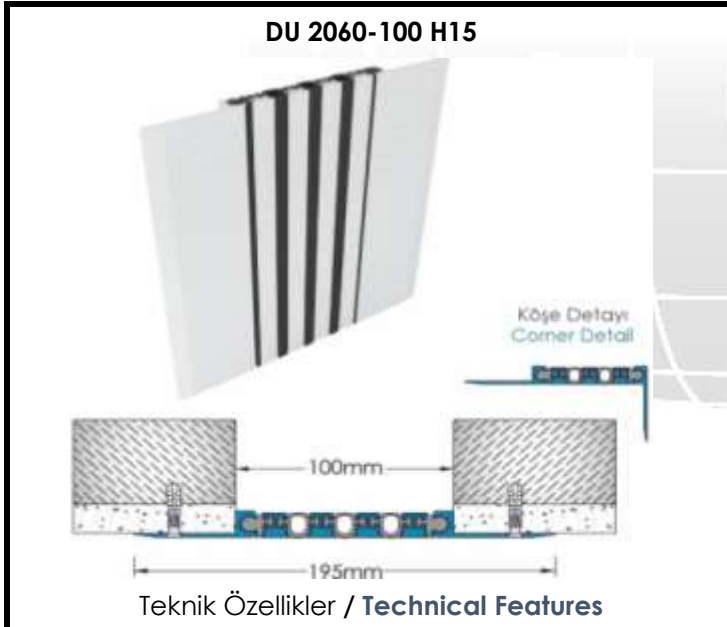

Dilatasyon Derz Açıklığı / Gap	100 mm
Yükseklik / Height	15 mm
Yüzey Genişliği / Surface Width	195 mm
Hareket Kapasitesi / Movement Capacity	± 15 mm

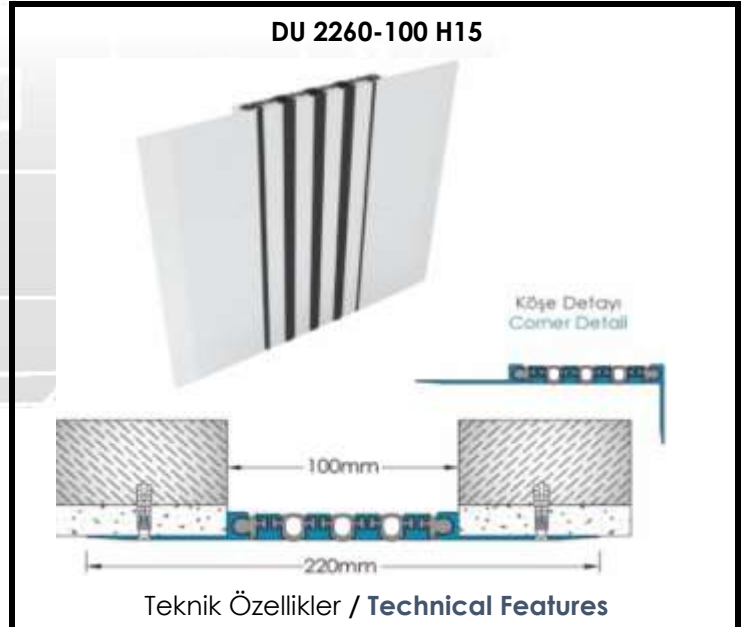

Dilatasyon Derz Açıklığı / Gap	100 mm
Yükseklik / Height	15 mm
Yüzey Genişliği / Surface Width	220 mm
Hareket Kapasitesi / Movement Capacity	± 15 mm



KAFES GROUP
Ostim Osb Mh. 1568 Cd. No:51
06374 Yenimahalle/Ankara/Turkey
Tel.:+90 (0) 535 248 97 85
WEB.: www.kafesgroup.com
EMAIL.: info@kafesgroup.com

KAFES GROUP PROFILE SYSTEMS

10cm Açıklık İçin Duvar-Tavan Dilatasyon Profilleri Wall-Ceiling Expansion Joint Profiles For 10cm Gaps

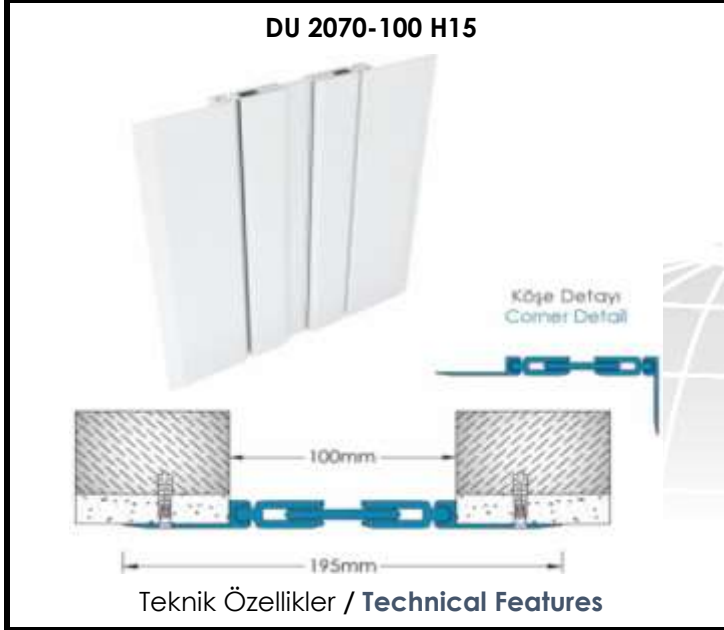

Dilatasyon Derz Açıklığı / Gap	100 mm
Yükseklik / Height	15 mm
Yüzey Genişliği / Surface Width	195 mm
Hareket Kapasitesi / Movement Capacity	± 15 mm

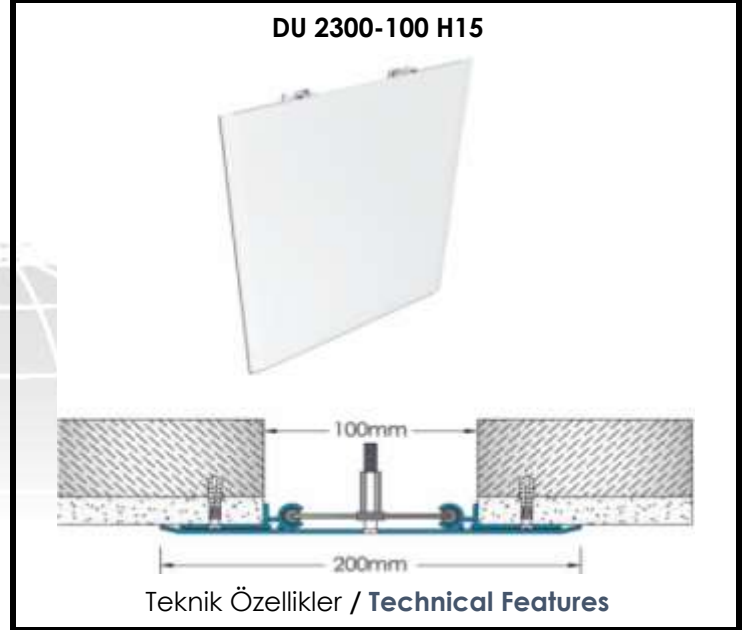

Dilatasyon Derz Açıklığı / Gap	100 mm
Yükseklik / Height	15 mm
Yüzey Genişliği / Surface Width	200 mm
Hareket Kapasitesi / Movement Capacity	± 50 mm

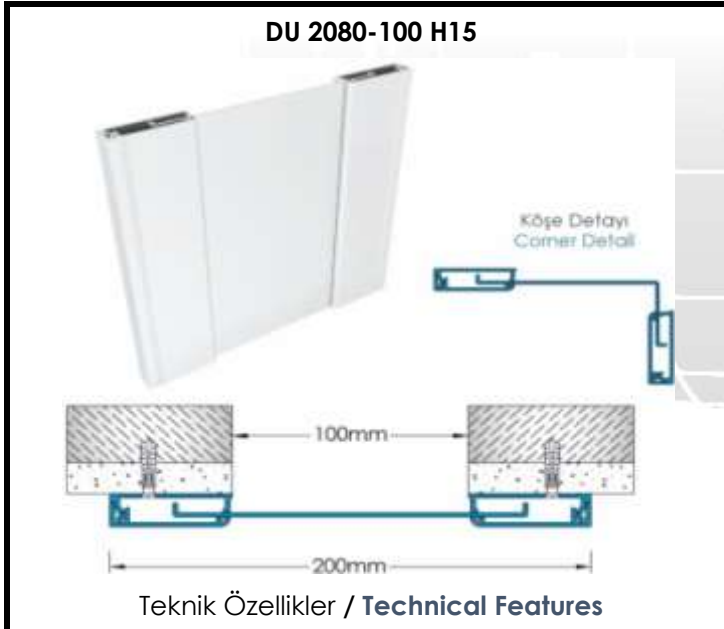

Dilatasyon Derz Açıklığı / Gap	100 mm
Yükseklik / Height	15 mm
Yüzey Genişliği / Surface Width	200 mm
Hareket Kapasitesi / Movement Capacity	± 50 mm

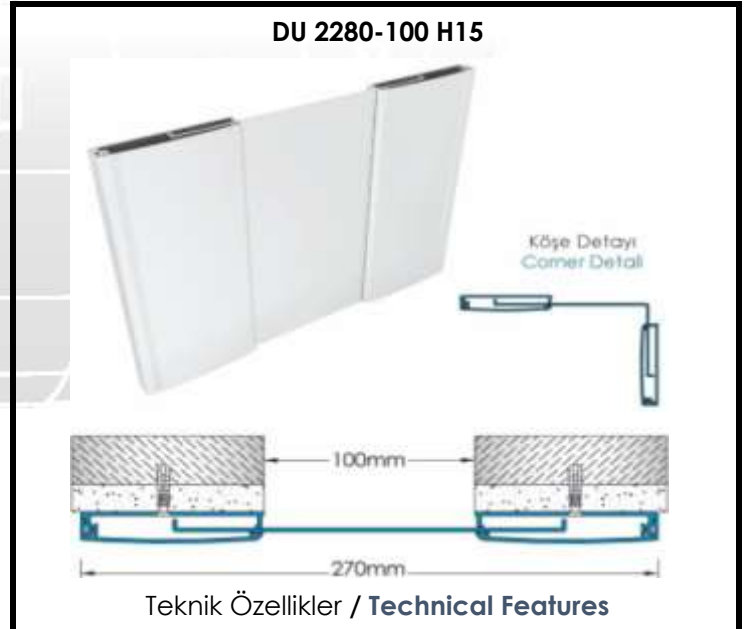

Dilatasyon Derz Açıklığı / Gap	100 mm
Yükseklik / Height	15 mm
Yüzey Genişliği / Surface Width	270 mm
Hareket Kapasitesi / Movement Capacity	± 75 mm



KAFES GROUP
Ostim Osb Mh. 1568 Cd. No:51
06374 Yenimahalle/Ankara/Turkey
Tel.:+90 (0) 535 248 97 85
WEB.: www.kafesgroup.com
EMAIL.: info@kafesgroup.com

KAFES GROUP PROFILE SYSTEMS

10cm Açıklık İçin Zemin Dilatasyon Profilleri Floor Expansion Joint Profiles For 3cm Gaps

ZA 3000-100 H45

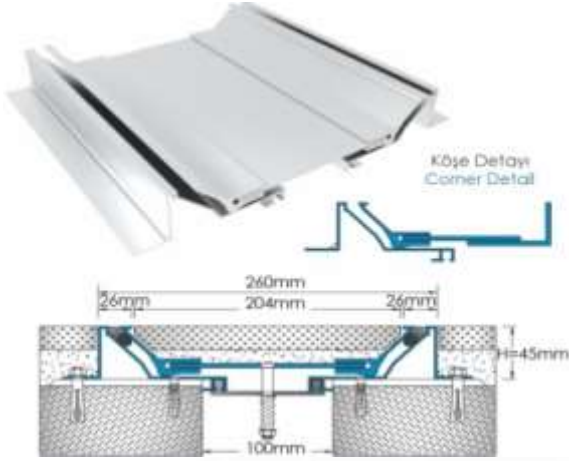

Teknik Özellikler / Technical Features

Dilatasyon Derz Açıklığı / Gap	100 mm
Yükseklik / Height	45 mm
Yüzey Genişliği / Surface Width	260 mm
Hareket Kapasitesi / Movement Capacity	± 50 mm
Yaya trafiğine dayanıklıdır / Resistant for pedestrian traffic	

ZA 3050-100 H70

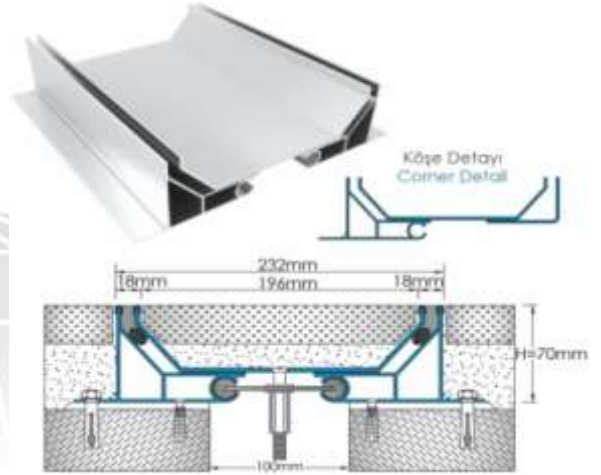

Teknik Özellikler / Technical Features

Dilatasyon Derz Açıklığı / Gap	100 mm
Yükseklik / Height	70 mm
Yüzey Genişliği / Surface Width	232 mm
Hareket Kapasitesi / Movement Capacity	± 50 mm
Yaya trafiğine dayanıklıdır / Resistant for pedestrian traffic	

ZA 3100-100 H40

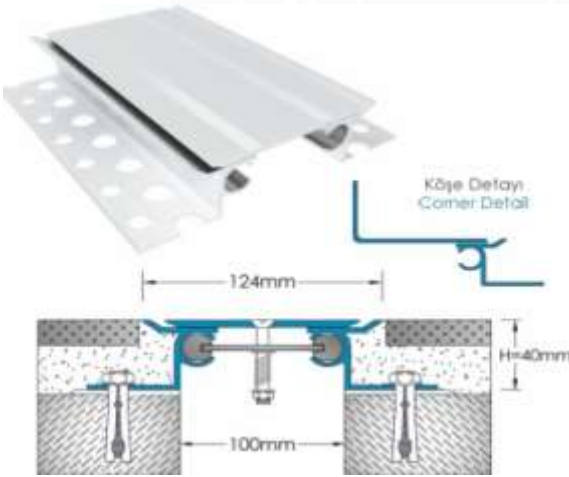

Teknik Özellikler / Technical Features

Dilatasyon Derz Açıklığı / Gap	100 mm
Yükseklik / Height	40 mm
Yüzey Genişliği / Surface Width	124 mm
Hareket Kapasitesi / Movement Capacity	± 50 mm
Hafif araç trafiğine dayanıklıdır / Resistant for light vehicle traffic	

ZA 3150-100 H40

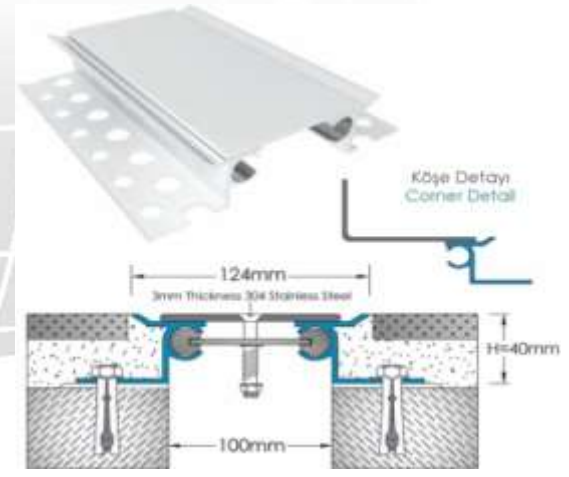

Teknik Özellikler / Technical Features

Dilatasyon Derz Açıklığı / Gap	100 mm
Yükseklik / Height	40 mm
Yüzey Genişliği / Surface Width	124 mm
Hareket Kapasitesi / Movement Capacity	± 50 mm
4,5 ton FORKLİFT, 12 ton KAMYON yüküne dayanıklıdır Resistan to the 4,5 tons FORKLIFT and 12 tons TRUCK load	



KAFES GROUP
Ostim Osb Mh. 1568 Cd. No:51
06374 Yenimahalle/Ankara/Turkey
Tel.:+90 (0) 535 248 97 85
WEB.: www.kafesgroup.com
EMAIL.: info@kafesgroup.com

KAFES GROUP PROFILE SYSTEMS

10cm Açıklık İçin Zemin Dilatasyon Profilleri Floor Expansion Joint Profiles For 3cm Gaps

ZA 3040-100 H15

Köşe Detayı
Corner Detail

100mm

100mm

H=15mm

Teknik Özellikler / Technical Features

Dilatasyon Derz Açıklığı / Gap	100 mm
Yükseklik / Height	15 mm
Yüzey Genişliği / Surface Width	10 mm
Hareket Kapasitesi / Movement Capacity	± 15 mm
Yaya trafiğine dayanıklıdır / Resistant for pedestrian traffic	

ZA 3045-100 H15

Köşe Detayı
Corner Detail

100mm

100mm

H=15mm

Teknik Özellikler / Technical Features

Dilatasyon Derz Açıklığı / Gap	100 mm
Yükseklik / Height	15 mm
Yüzey Genişliği / Surface Width	10 mm
Hareket Kapasitesi / Movement Capacity	± 12 mm
Yaya trafiğine dayanıklıdır / Resistant for pedestrian traffic	

ZA 3040-100 H30

Köşe Detayı
Corner Detail

100mm

100mm

H=30mm

Teknik Özellikler / Technical Features

Dilatasyon Derz Açıklığı / Gap	100 mm
Yükseklik / Height	30 mm
Yüzey Genişliği / Surface Width	10 mm
Hareket Kapasitesi / Movement Capacity	± 15 mm
Yaya trafiğine dayanıklıdır / Resistant for pedestrian traffic	

ZA 3045-100 H30

Köşe Detayı
Corner Detail

100mm

100mm

H=30mm

Teknik Özellikler / Technical Features

Dilatasyon Derz Açıklığı / Gap	100 mm
Yükseklik / Height	30 mm
Yüzey Genişliği / Surface Width	10 mm
Hareket Kapasitesi / Movement Capacity	± 12 mm
Yaya trafiğine dayanıklıdır / Resistant for pedestrian traffic	



KAFES GROUP
Ostim Osb Mh. 1568 Cd. No:51
06374 Yenimahalle/Ankara/Turkey
Tel.:+90 (0) 535 248 97 85
WEB.: www.kafesgroup.com
EMAIL.: info@kafesgroup.com

KAFES GROUP PROFILE SYSTEMS

10cm Açıklık İçin Zemin Dilatasyon Profilleri Floor Expansion Joint Profiles For 3cm Gaps

ZA 3040-100 H45

Köşe Detayı
Corner Detail

100mm

H=45mm

100mm

Teknik Özellikler / Technical Features

Dilatasyon Derz Açıklığı / Gap	100 mm
Yükseklik / Height	45 mm
Yüzey Genişliği / Surface Width	100 mm
Hareket Kapasitesi / Movement Capacity	± 15 mm
Yaya trafiğine dayanıklıdır / Resistant for pedestrian traffic	

ZA 3045-100 H45

Köşe Detayı
Corner Detail

100mm

H=45mm

100mm

Teknik Özellikler / Technical Features

Dilatasyon Derz Açıklığı / Gap	100 mm
Yükseklik / Height	45 mm
Yüzey Genişliği / Surface Width	100 mm
Hareket Kapasitesi / Movement Capacity	± 12 mm
Yaya trafiğine dayanıklıdır / Resistant for pedestrian traffic	

ZA 3260-100 H23

Köşe Detayı
Corner Detail

110mm

H=23mm

100mm

Teknik Özellikler / Technical Features

Dilatasyon Derz Açıklığı / Gap	100 mm
Yükseklik / Height	23 mm
Yüzey Genişliği / Surface Width	110 mm
Hareket Kapasitesi / Movement Capacity	± 15 mm
Yaya trafiğine dayanıklıdır / Resistant for pedestrian traffic	

ZA 3260-100 H43

Köşe Detayı
Corner Detail

105mm

H=43mm

100mm

Teknik Özellikler / Technical Features

Dilatasyon Derz Açıklığı / Gap	100 mm
Yükseklik / Height	43 mm
Yüzey Genişliği / Surface Width	105 mm
Hareket Kapasitesi / Movement Capacity	± 15 mm
Hafif araç trafiğine dayanıklıdır / Resistant for light vehicle traffic	



KAFES GROUP
Ostim Osb Mh. 1568 Cd. No:51
06374 Yenimahalle/Ankara/Turkey
Tel.:+90 (0) 535 248 97 85
WEB.: www.kafesgroup.com
EMAIL.: info@kafesgroup.com

KAFES GROUP PROFILE SYSTEMS

10cm Açıklık İçin Zemin Dilatasyon Profilleri Floor Expansion Joint Profiles For 3cm Gaps

ZA 3060-100 H43

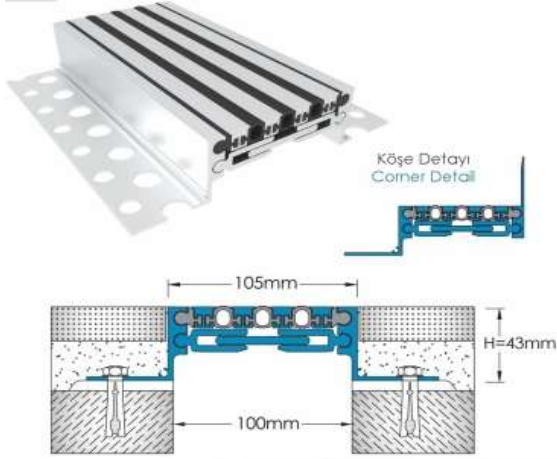

Teknik Özellikler / Technical Features

Dilatasyon Derz Açıklığı / Gap	100 mm
Yükseklik / Height	43 mm
Yüzey Genişliği / Surface Width	105 mm
Hareket Kapasitesi / Movement Capacity	± 15 mm
Hafif araç trafiğine dayanıklıdır / Resistant for light vehicle traffic	

ZA 3250-100 H25

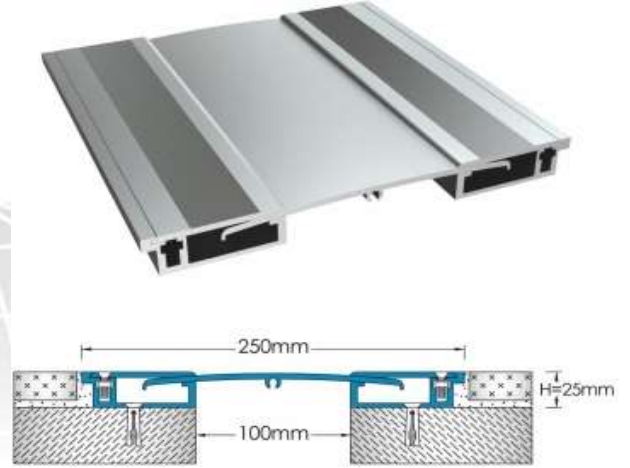

Teknik Özellikler / Technical Features

Dilatasyon Derz Açıklığı / Gap	100 mm
Yükseklik / Height	25 mm
Yüzey Genişliği / Surface Width	250 mm
Hareket Kapasitesi / Movement Capacity	+ 50/-30 mm
Hafif araç trafiğine dayanıklıdır / Resistant for light vehicle traffic	

ZA 3070-100 H15

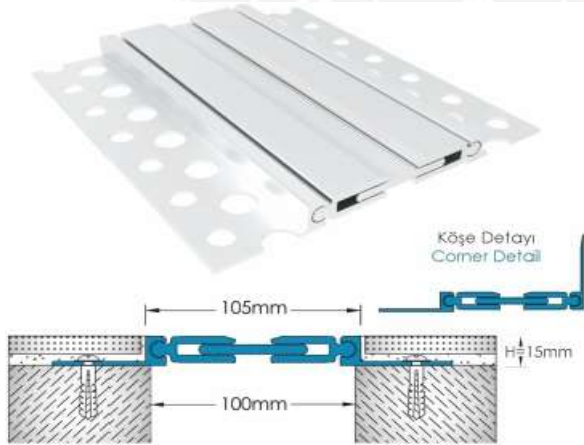

Teknik Özellikler / Technical Features

Dilatasyon Derz Açıklığı / Gap	100 mm
Yükseklik / Height	15 mm
Yüzey Genişliği / Surface Width	105 mm
Hareket Kapasitesi / Movement Capacity	± 15 mm
Yaya trafiğine dayanıklıdır / Resistant for pedestrian traffic	

ZA 3070-100 H43

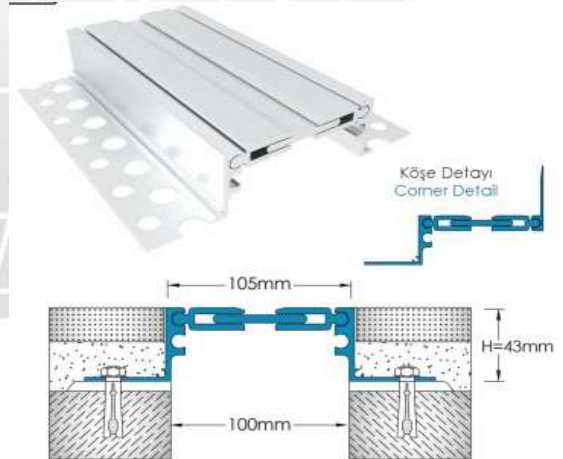

Teknik Özellikler / Technical Features

Dilatasyon Derz Açıklığı / Gap	100 mm
Yükseklik / Height	43 mm
Yüzey Genişliği / Surface Width	105 mm
Hareket Kapasitesi / Movement Capacity	± 15 mm
Hafif araç trafiğine dayanıklıdır / Resistant for light vehicle traffic	



KAFES GROUP
Ostim Osb Mh. 1568 Cd. No:51
06374 Yenimahalle/Ankara/Turkey
Tel.:+90 (0) 535 248 97 85
WEB.: www.kafesgroup.com
EMAIL.: info@kafesgroup.com

KAFES GROUP PROFILE SYSTEMS

10cm Açıklık İçin Zemin Dilatasyon Profilleri Floor Expansion Joint Profiles For 3cm Gaps

ZA 3130-100 H50

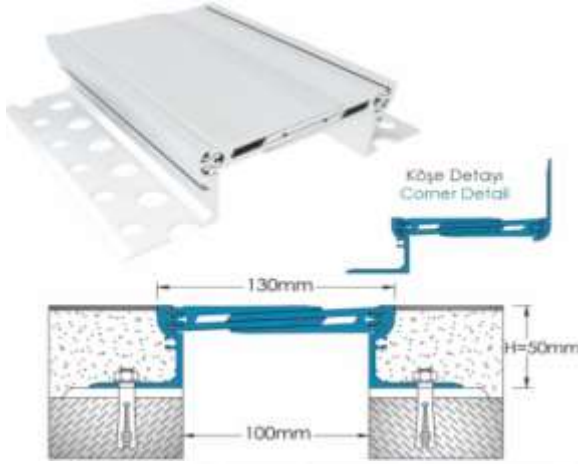

Teknik Özellikler / Technical Features

Dilatasyon Derz Açıklığı / Gap	100 mm
Yükseklik / Height	50 mm
Yüzey Genişliği / Surface Width	130 mm
Hareket Kapasitesi / Movement Capacity	± 20 mm
6,5 ton FORKLİFT, 30 ton KAMYON yüküne dayanıklıdır Resistan to the 6,5 tons FORKLIFT and 30 tons TRUCK load	

ZA 3130-100 H70

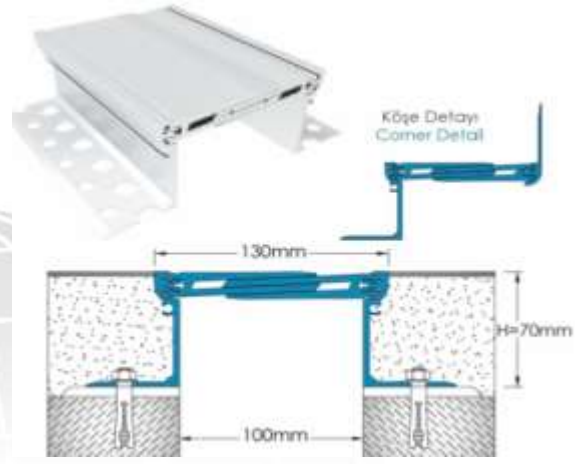

Teknik Özellikler / Technical Features

Dilatasyon Derz Açıklığı / Gap	100 mm
Yükseklik / Height	70 mm
Yüzey Genişliği / Surface Width	130 mm
Hareket Kapasitesi / Movement Capacity	± 20 mm
6,5 ton FORKLİFT, 30 ton KAMYON yüküne dayanıklıdır Resistan to the 6,5 tons FORKLIFT and 30 tons TRUCK load	

ZA 3030-100 H50

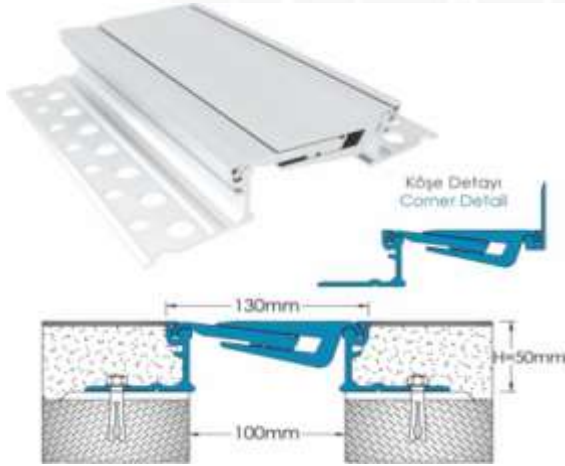

Teknik Özellikler / Technical Features

Dilatasyon Derz Açıklığı / Gap	100 mm
Yükseklik / Height	50 mm
Yüzey Genişliği / Surface Width	130 mm
Hareket Kapasitesi / Movement Capacity	± 20 mm
6,5 ton FORKLİFT, 30 ton KAMYON yüküne dayanıklıdır Resistan to the 6,5 tons FORKLIFT and 30 tons TRUCK load	

ZA 3030-100 H70

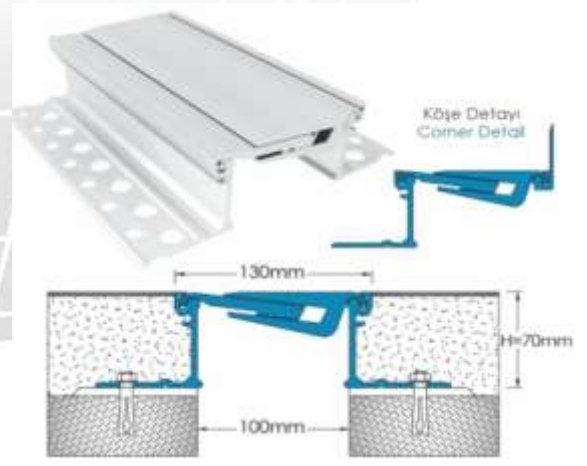

Teknik Özellikler / Technical Features

Dilatasyon Derz Açıklığı / Gap	100 mm
Yükseklik / Height	50 mm
Yüzey Genişliği / Surface Width	130 mm
Hareket Kapasitesi / Movement Capacity	± 20 mm
6,5 ton FORKLİFT, 30 ton KAMYON yüküne dayanıklıdır Resistan to the 6,5 tons FORKLIFT and 30 tons TRUCK load	



KAFES GROUP
Ostim Osb Mh. 1568 Cd. No:51
06374 Yenimahalle/Ankara/Turkey
Tel.:+90 (0) 535 248 97 85
WEB.: www.kafesgroup.com
EMAIL.: info@kafesgroup.com

KAFES GROUP PROFILE SYSTEMS

10cm Açıklık İçin Zemin Dilatasyon Profilleri Floor Expansion Joint Profiles For 3cm Gaps

ZA 3090-100 H60

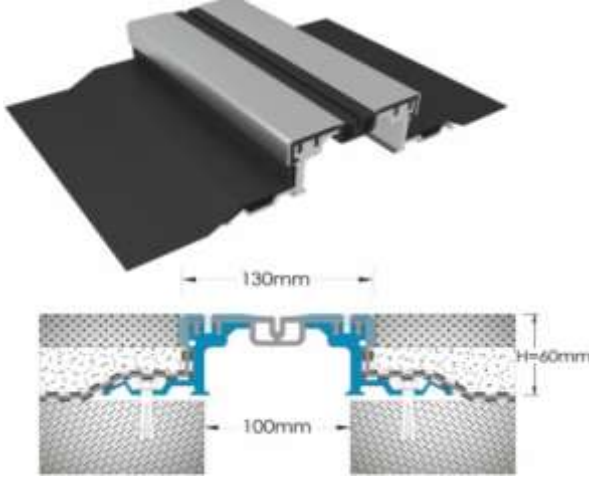

Teknik Özellikler / Technical Features

Dilatasyon Derz Açıklığı / Gap	100 mm
Yükseklik / Height	60 mm
Yüzey Genişliği / Surface Width	130 mm
Hareket Kapasitesi / Movement Capacity	± 20 mm
3,5 ton FORKLİFT, 9 ton KAMYON yüküne dayanıklıdır Resistan to the 3,5 tons FORKLIFT and 9 tons TRUCK load	

ZA 3290-100 H60

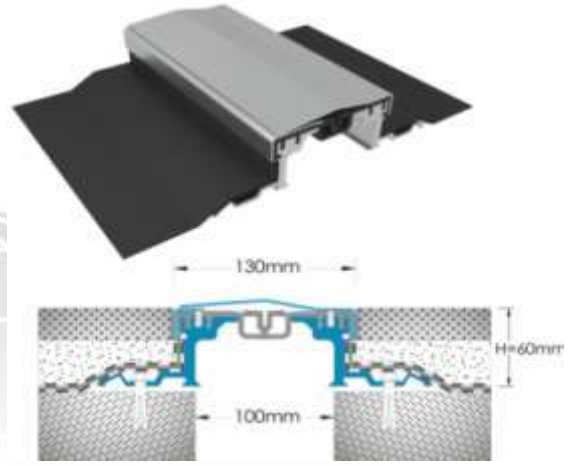

Teknik Özellikler / Technical Features

Dilatasyon Derz Açıklığı / Gap	100 mm
Yükseklik / Height	60 mm
Yüzey Genişliği / Surface Width	130 mm
Hareket Kapasitesi / Movement Capacity	± 20 mm
3,5 ton FORKLİFT, 9 ton KAMYON yüküne dayanıklıdır Resistan to the 3,5 tons FORKLIFT and 9 tons TRUCK load	

ZU 4090-100 H65

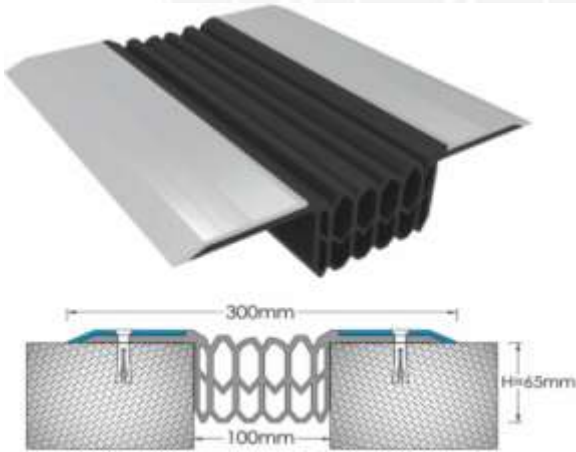

Teknik Özellikler / Technical Features

Dilatasyon Derz Açıklığı / Gap	100 mm
Yükseklik / Height	65 mm
Yüzey Genişliği / Surface Width	300 mm
Hareket Kapasitesi / Movement Capacity	± 25 mm
Hafif araç trafiğine dayanıklıdır / Resistant for light vehicle traffic	

ZU 4250-100 H100

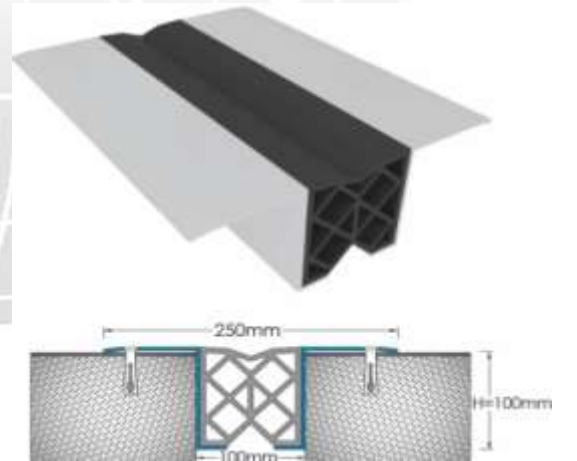

Teknik Özellikler / Technical Features

Dilatasyon Derz Açıklığı / Gap	100 mm
Yükseklik / Height	100 mm
Yüzey Genişliği / Surface Width	250 mm
Hareket Kapasitesi / Movement Capacity	± 25 mm
Hafif araç trafiğine dayanıklıdır / Resistant for light vehicle traffic	



KAFES GROUP
Ostim Osb Mh. 1568 Cd. No:51
06374 Yenimahalle/Ankara/Turkey
Tel.:+90 (0) 535 248 97 85
WEB.: www.kafesgroup.com
EMAIL.: info@kafesgroup.com

KAFES GROUP PROFILE SYSTEMS

10cm Açıklık İçin Zemin Dilatasyon Profilleri Floor Expansion Joint Profiles For 3cm Gaps

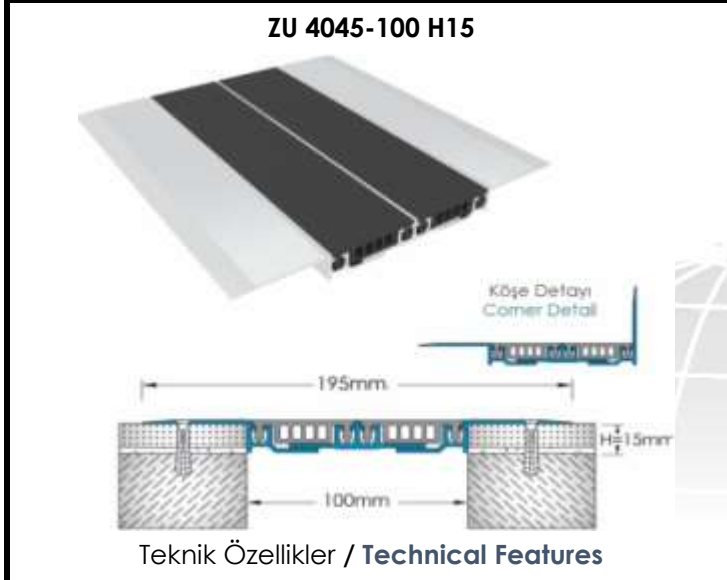

Dilatasyon Derz Açıklığı / Gap	100 mm
Yükseklik / Height	15 mm
Yüzey Genişliği / Surface Width	195 mm
Hareket Kapasitesi / Movement Capacity	± 12 mm
Yaya trafiğine dayanıklıdır / Resistant for pedestrian traffic	

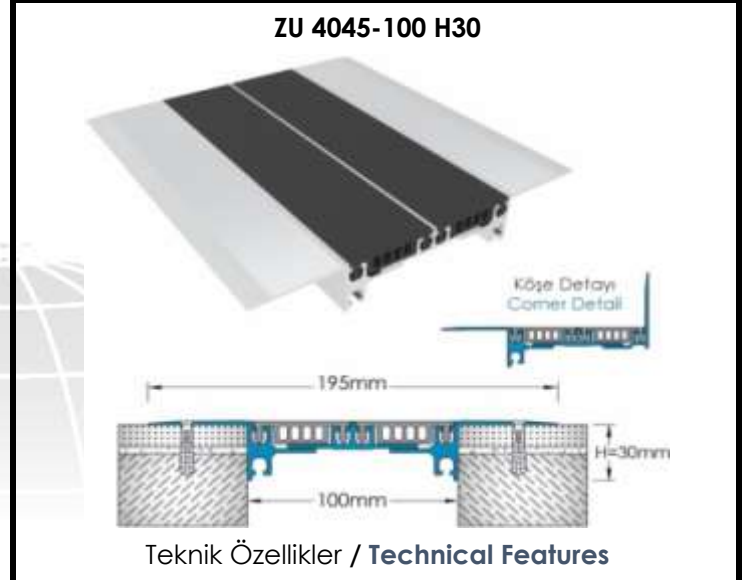

Dilatasyon Derz Açıklığı / Gap	100 mm
Yükseklik / Height	30 mm
Yüzey Genişliği / Surface Width	195 mm
Hareket Kapasitesi / Movement Capacity	± 12 mm
Yaya trafiğine dayanıklıdır / Resistant for pedestrian traffic	



Dilatasyon Derz Açıklığı / Gap	100 mm
Yükseklik / Height	30 mm
Yüzey Genişliği / Surface Width	220 mm
Hareket Kapasitesi / Movement Capacity	± 14 mm
Hafif araç trafiğine dayanıklıdır / Resistant for light vehicle traffic	

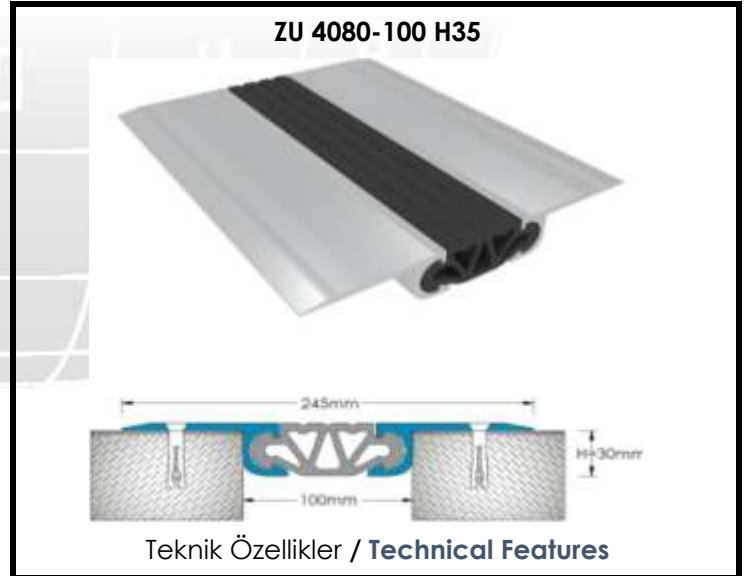

Dilatasyon Derz Açıklığı / Gap	100 mm
Yükseklik / Height	30 mm
Yüzey Genişliği / Surface Width	245 mm
Hareket Kapasitesi / Movement Capacity	± 15 mm
30 ton KAMYON yüküne dayanabilir. / Resistant to 30 tons TRUCK load.	



KAFES GROUP
Ostim Osb Mh. 1568 Cd. No:51
06374 Yenimahalle/Ankara/Turkey
Tel.:+90 (0) 535 248 97 85
WEB.: www.kafesgroup.com
EMAIL.: info@kafesgroup.com

KAFES GROUP PROFILE SYSTEMS

10cm Açıklık İçin Zemin Dilatasyon Profilleri Floor Expansion Joint Profiles For 3cm Gaps

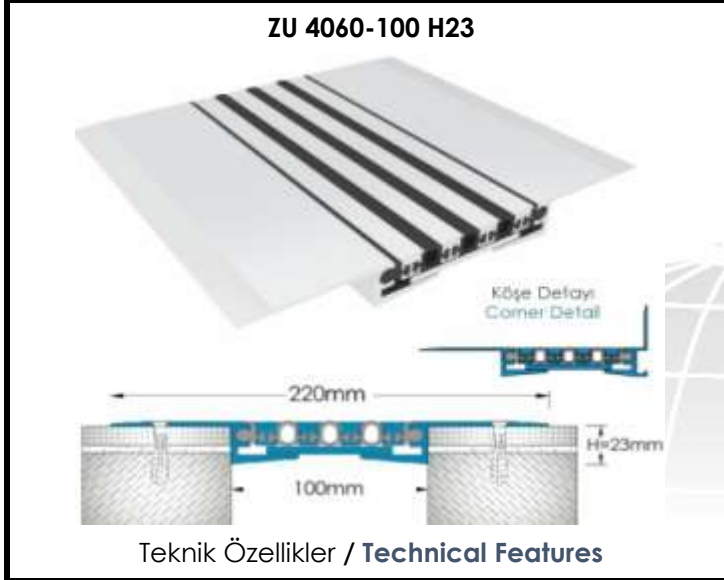

Dilatasyon Derz Açıklığı / Gap	100 mm
Yükseklik / Height	23 mm
Yüzey Genişliği / Surface Width	220 mm
Hareket Kapasitesi / Movement Capacity	± 15 mm
Hafif araç trafiğine dayanıklıdır / Resistant for light vehicle traffic	

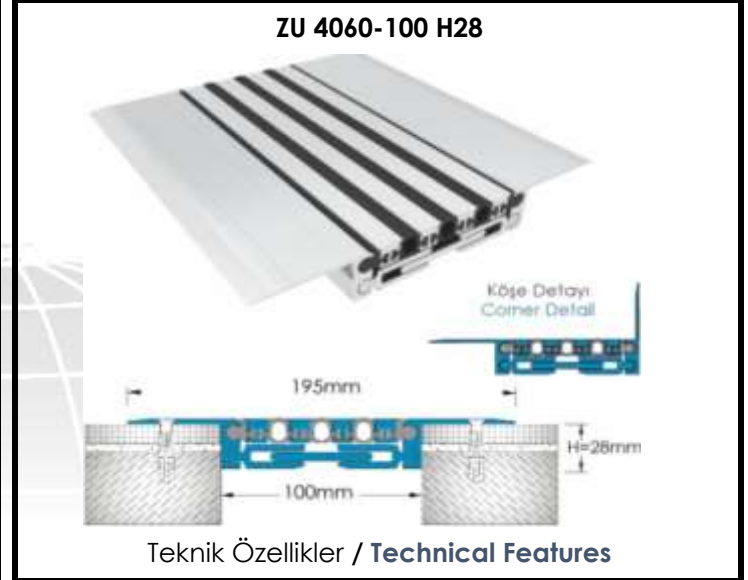

Dilatasyon Derz Açıklığı / Gap	100 mm
Yükseklik / Height	28 mm
Yüzey Genişliği / Surface Width	195 mm
Hareket Kapasitesi / Movement Capacity	± 15 mm
Hafif araç trafiğine dayanıklıdır / Resistant for light vehicle traffic	



Dilatasyon Derz Açıklığı / Gap	100 mm
Yükseklik / Height	14 mm
Yüzey Genişliği / Surface Width	245 mm
Hareket Kapasitesi / Movement Capacity	± 12 mm
1,5 ton FORKLİFT, 6 ton KAMYON yüküne dayanıklıdır Resistan to the 1,5 tons FORKLIFT and 6 tons TRUCK load	



Dilatasyon Derz Açıklığı / Gap	100 mm
Yükseklik / Height	16 mm
Yüzey Genişliği / Surface Width	235 mm
Hareket Kapasitesi / Movement Capacity	± 12 mm
1,5 ton FORKLİFT, 6 ton KAMYON yüküne dayanıklıdır Resistan to the 1,5 tons FORKLIFT and 6 tons TRUCK load	



KAFES GROUP
Ostim Osb Mh. 1568 Cd. No:51
06374 Yenimahalle/Ankara/Turkey
Tel.:+90 (0) 535 248 97 85
WEB.: www.kafesgroup.com
EMAIL.: info@kafesgroup.com

KAFES GROUP PROFILE SYSTEMS

12cm Açıklık İçin Duvar-Tavan Dilatasyon Profilleri Wall-Ceiling Expansion Joint Profiles For 12cm Gaps

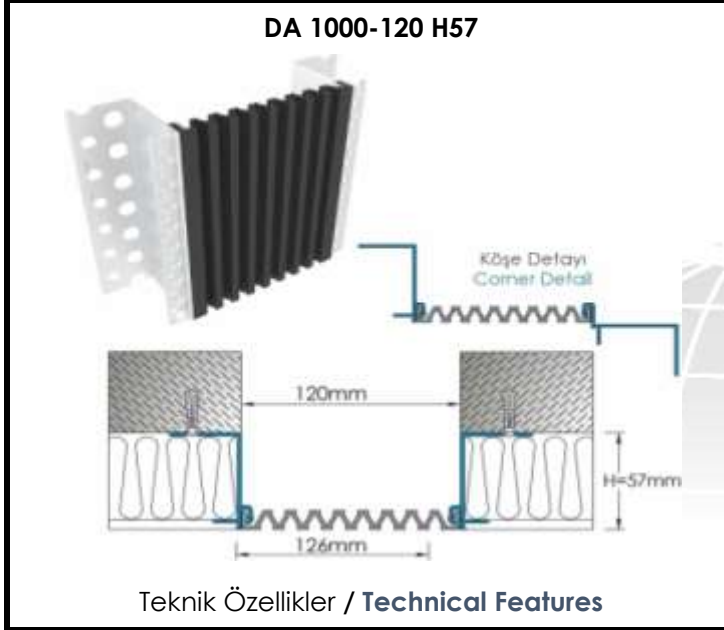

Dilatasyon Derz Açıklığı / Gap	120 mm
Yükseklik / Height	57 mm
Yüzey Genişliği / Surface Width	126 mm
Hareket Kapasitesi / Movement Capacity	± 60 mm

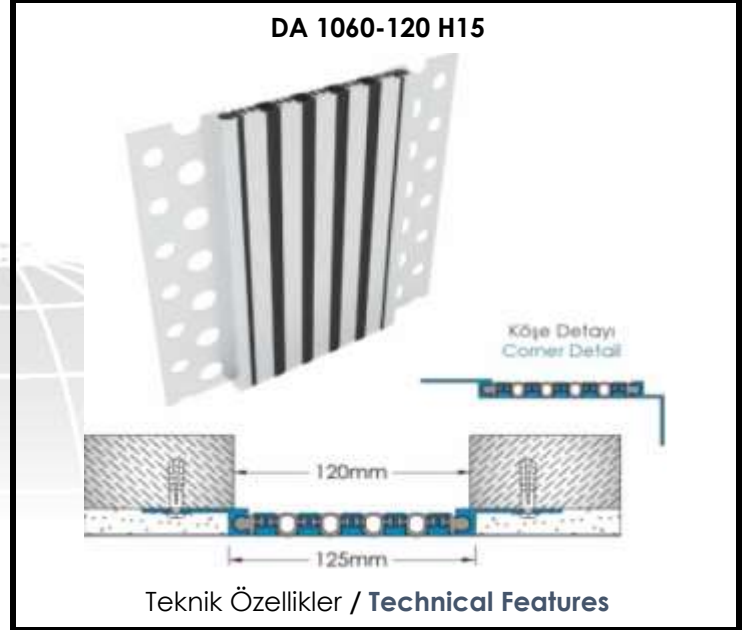

Dilatasyon Derz Açıklığı / Gap	120 mm
Yükseklik / Height	15 mm
Yüzey Genişliği / Surface Width	125 mm
Hareket Kapasitesi / Movement Capacity	± 20 mm

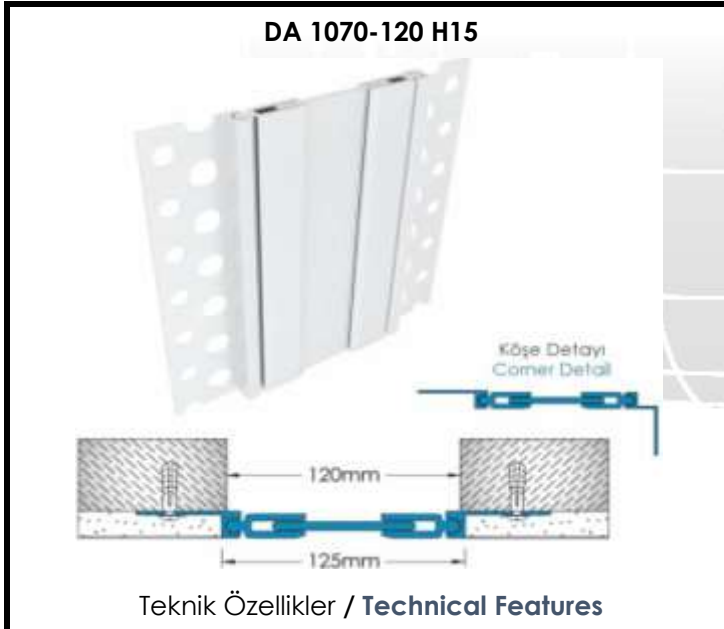

Dilatasyon Derz Açıklığı / Gap	120 mm
Yükseklik / Height	15 mm
Yüzey Genişliği / Surface Width	125 mm
Hareket Kapasitesi / Movement Capacity	± 20 mm

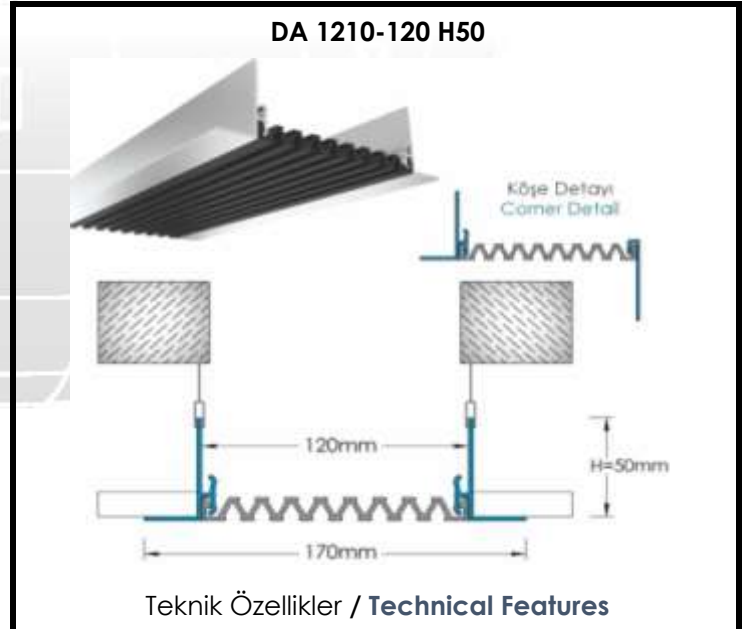

Dilatasyon Derz Açıklığı / Gap	120 mm
Yükseklik / Height	50 mm
Yüzey Genişliği / Surface Width	170 mm
Hareket Kapasitesi / Movement Capacity	± 60 mm



KAFES GROUP
Ostim Osb Mh. 1568 Cd. No:51
06374 Yenimahalle/Ankara/Turkey
Tel.:+90 (0) 535 248 97 85
WEB.: www.kafesgroup.com
EMAIL.: info@kafesgroup.com

KAFES GROUP PROFILE SYSTEMS

12cm Açıklık İçin Duvar-Tavan Dilatasyon Profilleri Wall-Ceiling Expansion Joint Profiles For 12cm Gaps

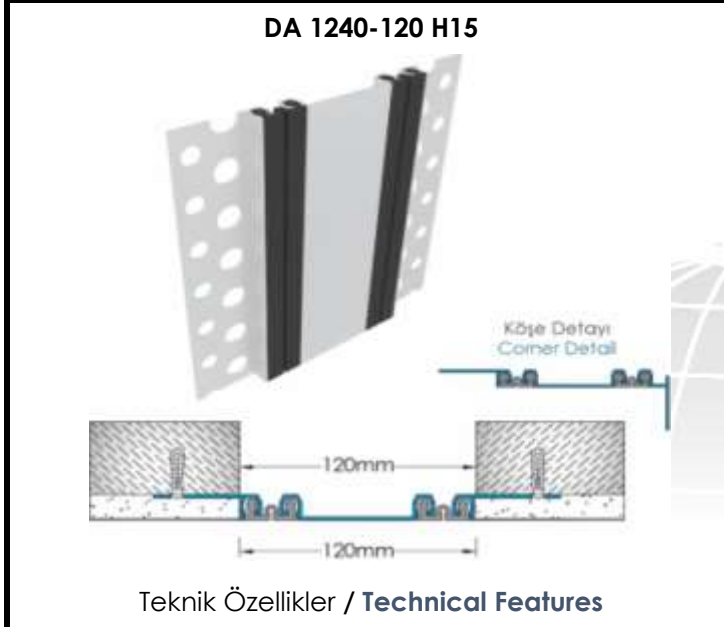

Dilatasyon Derz Açıklığı / Gap	120 mm
Yükseklik / Height	15 mm
Yüzey Genişliği / Surface Width	120 mm
Hareket Kapasitesi / Movement Capacity	± 14 mm

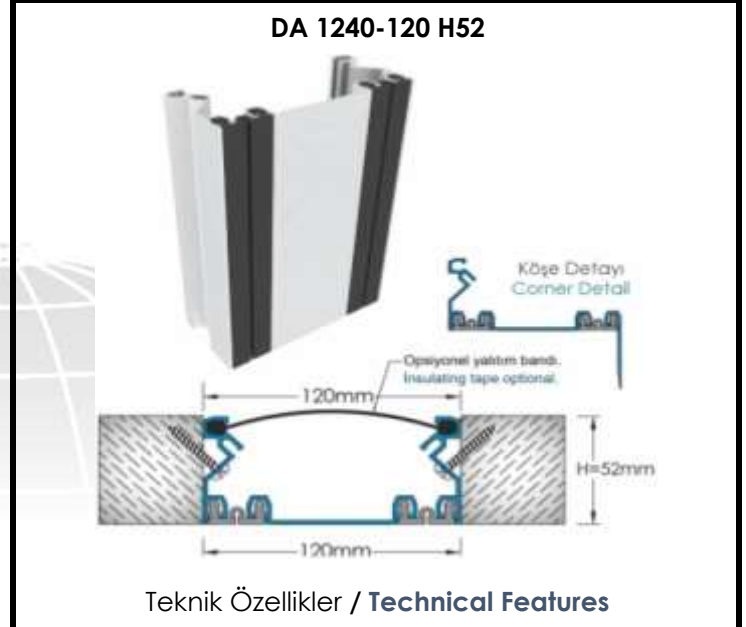

Dilatasyon Derz Açıklığı / Gap	120 mm
Yükseklik / Height	52 mm
Yüzey Genişliği / Surface Width	120 mm
Hareket Kapasitesi / Movement Capacity	± 14 mm

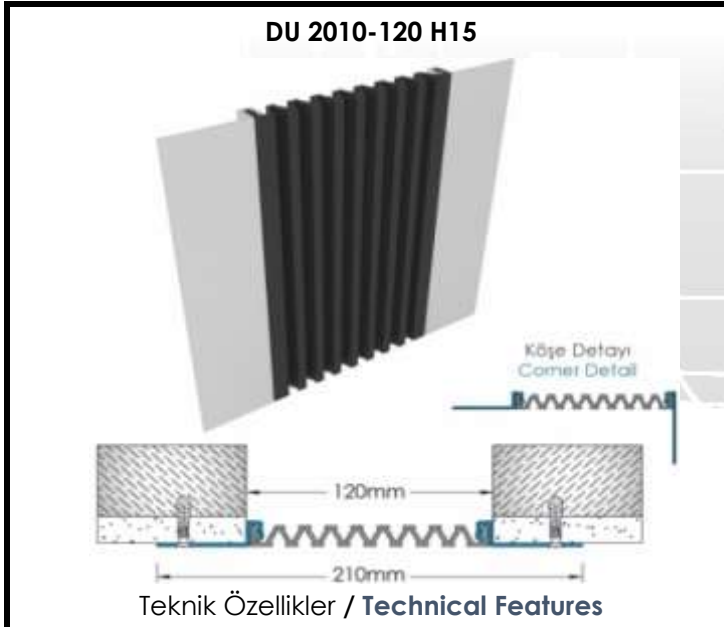

Dilatasyon Derz Açıklığı / Gap	120 mm
Yükseklik / Height	15 mm
Yüzey Genişliği / Surface Width	210 mm
Hareket Kapasitesi / Movement Capacity	± 60 mm

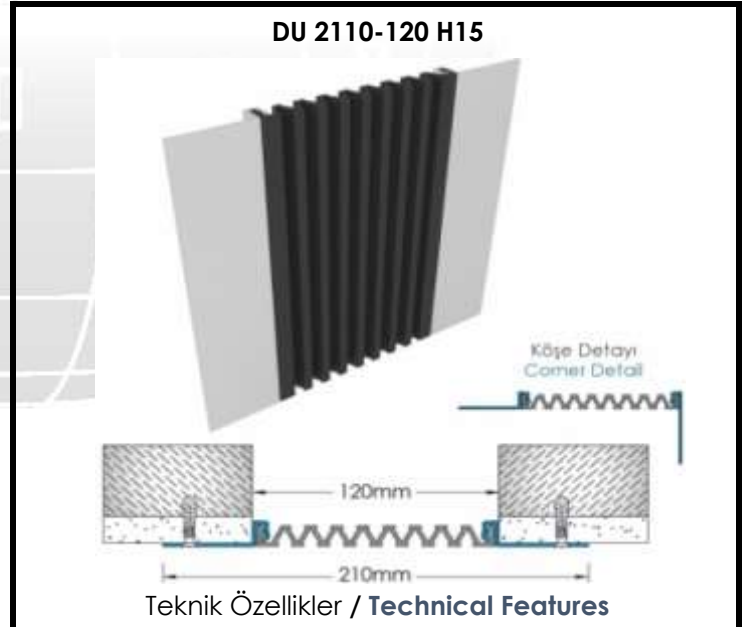

Dilatasyon Derz Açıklığı / Gap	120 mm
Yükseklik / Height	15 mm
Yüzey Genişliği / Surface Width	230 mm
Hareket Kapasitesi / Movement Capacity	± 60 mm



KAFES GROUP
Ostim Osb Mh. 1568 Cd. No:51
06374 Yenimahalle/Ankara/Turkey
Tel.:+90 (0) 535 248 97 85
WEB.: www.kafesgroup.com
EMAIL.: info@kafesgroup.com

KAFES GROUP PROFILE SYSTEMS

12cm Açıklık İçin Duvar-Tavan Dilatasyon Profilleri Wall-Ceiling Expansion Joint Profiles For 12cm Gaps

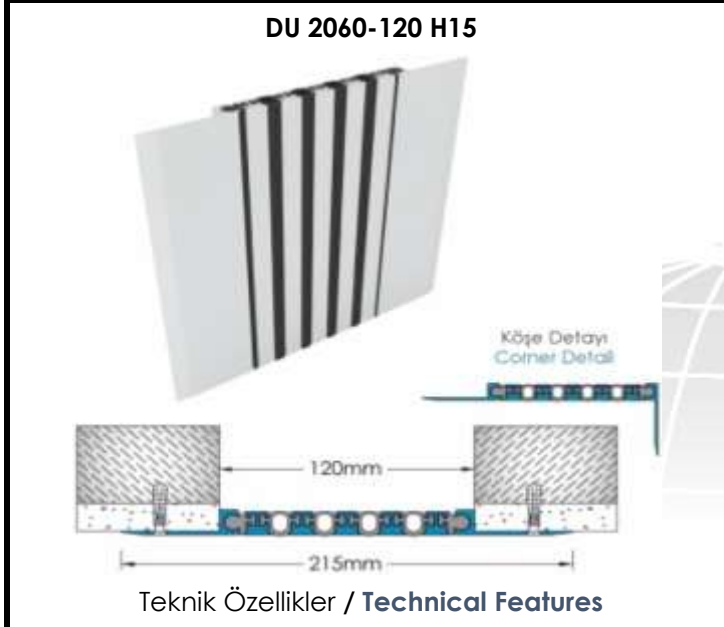

Dilatasyon Derz Açıklığı / Gap	120 mm
Yükseklik / Height	15 mm
Yüzey Genişliği / Surface Width	215 mm
Hareket Kapasitesi / Movement Capacity	± 20 mm

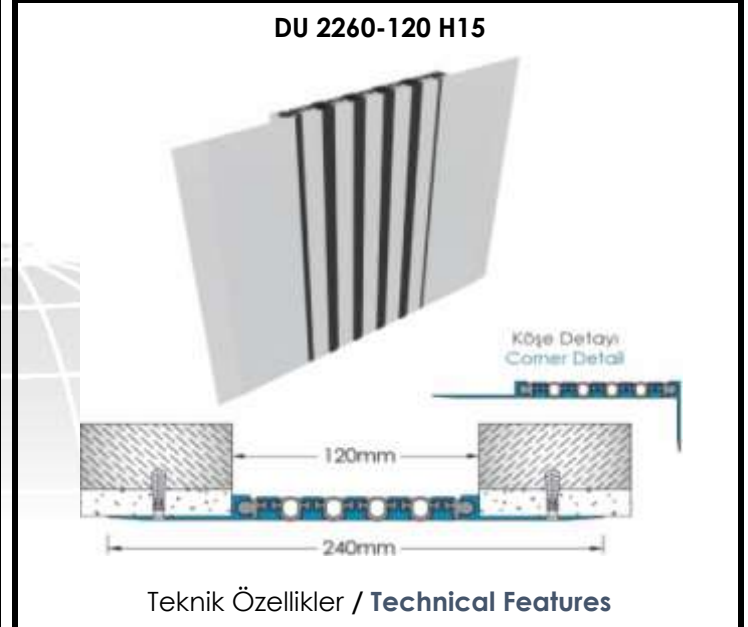

Dilatasyon Derz Açıklığı / Gap	120 mm
Yükseklik / Height	15 mm
Yüzey Genişliği / Surface Width	240 mm
Hareket Kapasitesi / Movement Capacity	± 20 mm

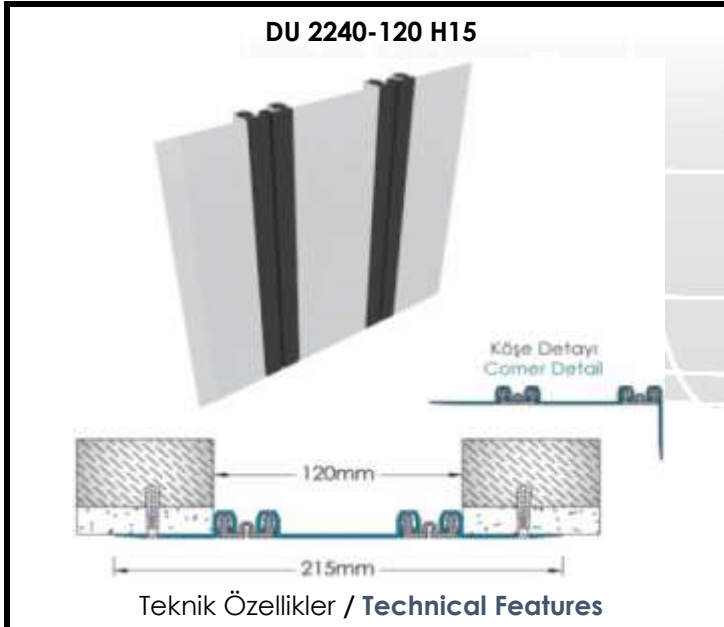

Dilatasyon Derz Açıklığı / Gap	120 mm
Yükseklik / Height	15 mm
Yüzey Genişliği / Surface Width	215 mm
Hareket Kapasitesi / Movement Capacity	± 14 mm

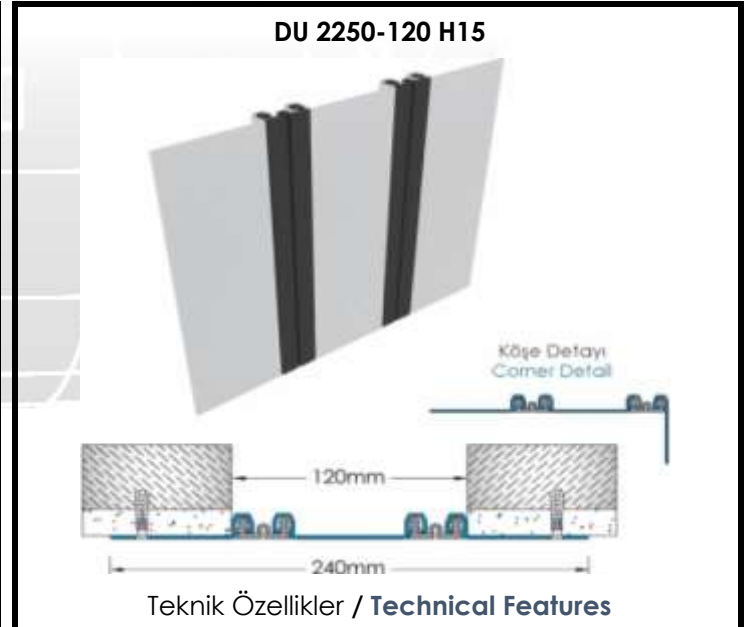

Dilatasyon Derz Açıklığı / Gap	120 mm
Yükseklik / Height	15 mm
Yüzey Genişliği / Surface Width	240 mm
Hareket Kapasitesi / Movement Capacity	± 14 mm



KAFES GROUP
Ostim Osb Mh. 1568 Cd. No:51
06374 Yenimahalle/Ankara/Turkey
Tel.:+90 (0) 535 248 97 85
WEB.: www.kafesgroup.com
EMAIL.: info@kafesgroup.com

KAFES GROUP PROFILE SYSTEMS

12cm Açıklık İçin Duvar-Tavan Dilatasyon Profilleri Wall-Ceiling Expansion Joint Profiles For 12cm Gaps

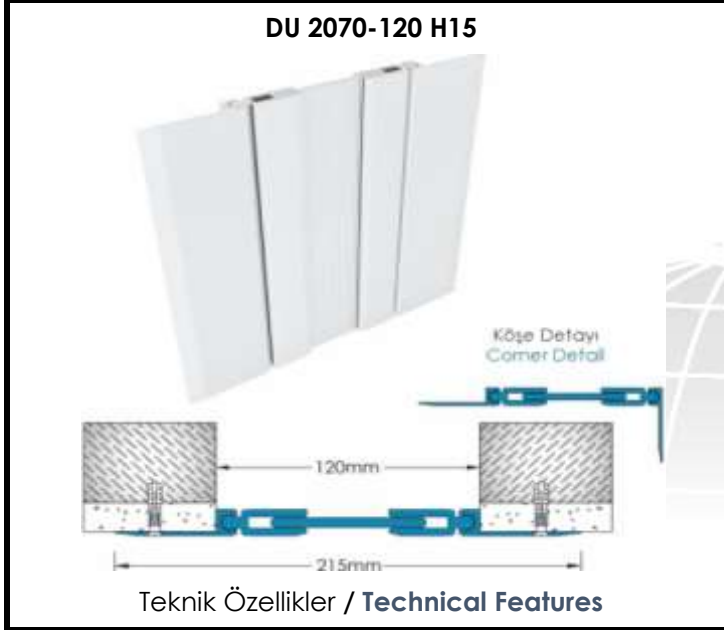

Dilatasyon Derz Açıklığı / Gap	120 mm
Yükseklik / Height	15 mm
Yüzey Genişliği / Surface Width	215 mm
Hareket Kapasitesi / Movement Capacity	± 20 mm

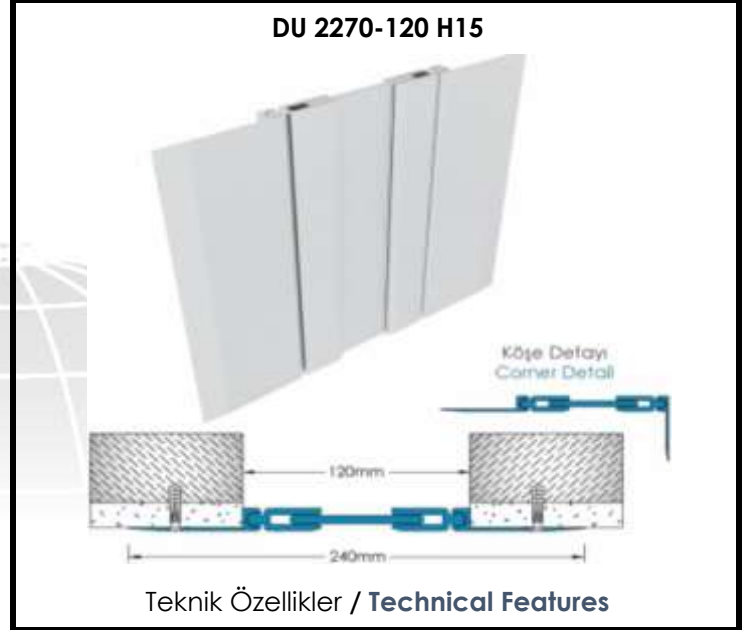

Dilatasyon Derz Açıklığı / Gap	120 mm
Yükseklik / Height	15 mm
Yüzey Genişliği / Surface Width	240 mm
Hareket Kapasitesi / Movement Capacity	± 20 mm

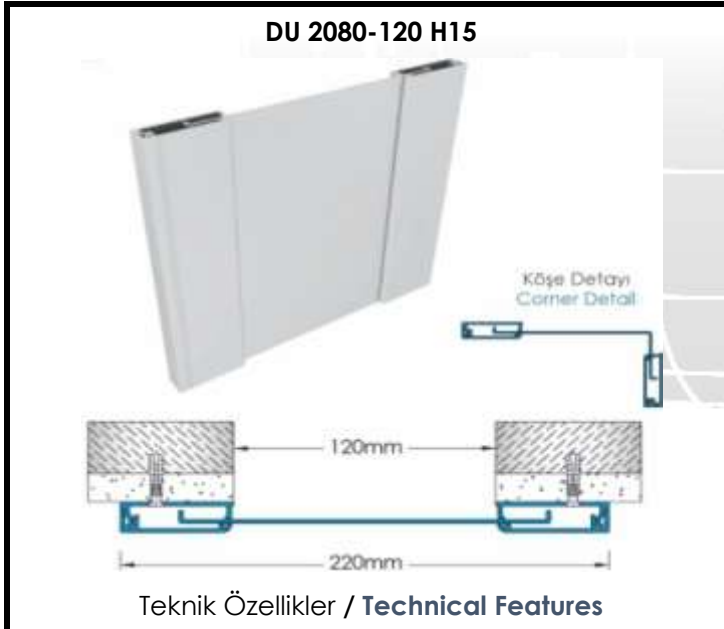

Dilatasyon Derz Açıklığı / Gap	120 mm
Yükseklik / Height	15 mm
Yüzey Genişliği / Surface Width	220 mm
Hareket Kapasitesi / Movement Capacity	± 60 mm

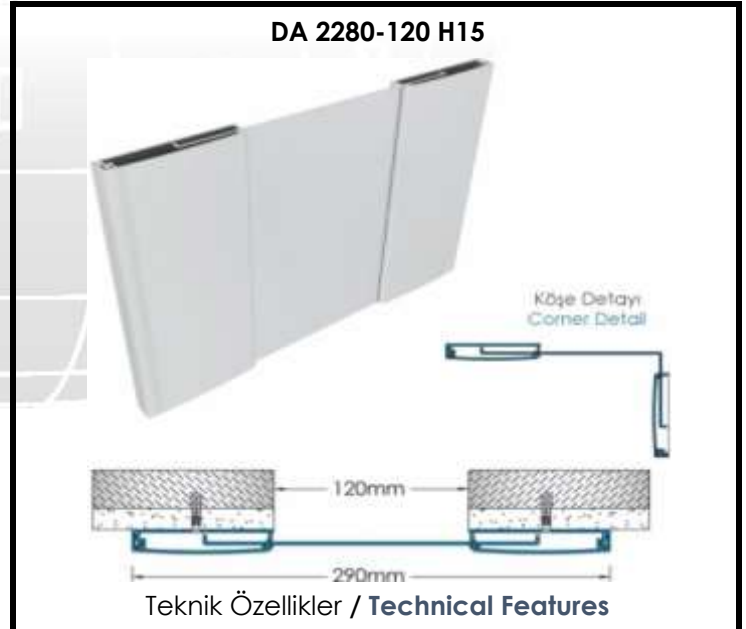

Dilatasyon Derz Açıklığı / Gap	120 mm
Yükseklik / Height	15 mm
Yüzey Genişliği / Surface Width	290 mm
Hareket Kapasitesi / Movement Capacity	± 75 mm



KAFES GROUP
Ostim Osb Mh. 1568 Cd. No:51
06374 Yenimahalle/Ankara/Turkey
Tel.:+90 (0) 535 248 97 85
WEB.: www.kafesgroup.com
EMAIL.: info@kafesgroup.com

KAFES GROUP PROFILE SYSTEMS

12cm Açıklık İçin Zemin Dilatasyon Profilleri Floor Expansion Joint Profiles For 12cm Gaps

ZA 3000-120 H45

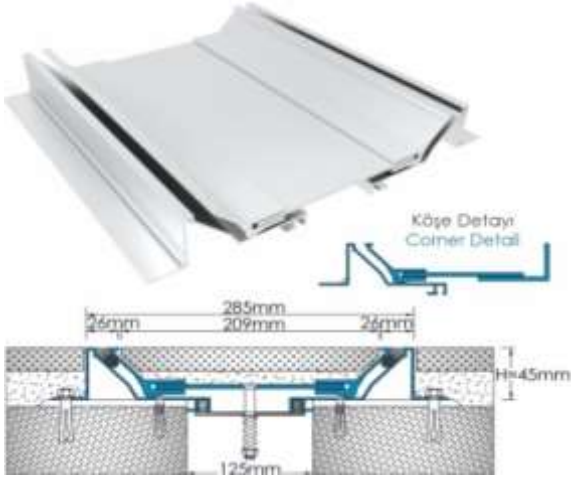

Teknik Özellikler / Technical Features

Dilatasyon Derz Açıklığı / Gap	125 mm
Yükseklik / Height	45 mm
Yüzey Genişliği / Surface Width	285 mm
Hareket Kapasitesi / Movement Capacity	± 60 mm
Yaya trafiğine dayanıklıdır / Resistant for pedestrian traffic	

ZA 3040-120 H30

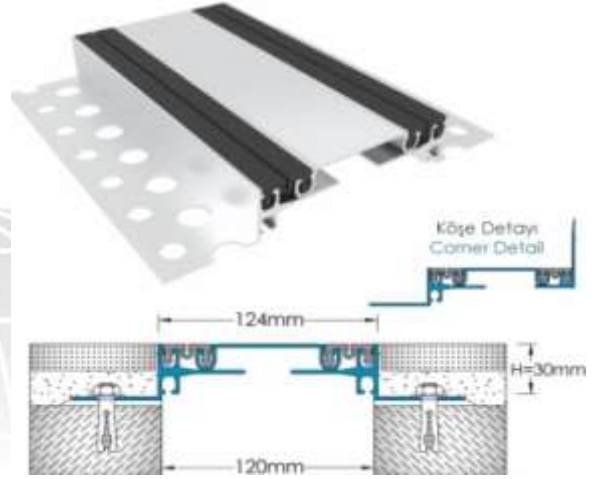

Teknik Özellikler / Technical Features

Dilatasyon Derz Açıklığı / Gap	120 mm
Yükseklik / Height	30 mm
Yüzey Genişliği / Surface Width	124 mm
Hareket Kapasitesi / Movement Capacity	± 14 mm
Yaya trafiğine dayanıklıdır / Resistant for pedestrian traffic	

ZA 3100-120 H40

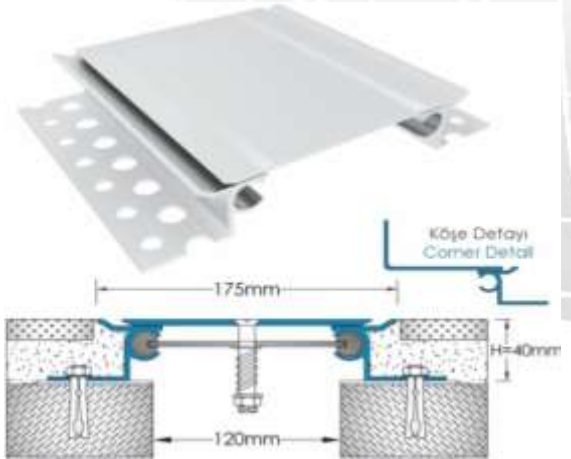

Teknik Özellikler / Technical Features

Dilatasyon Derz Açıklığı / Gap	120 mm
Yükseklik / Height	40 mm
Yüzey Genişliği / Surface Width	175 mm
Hareket Kapasitesi / Movement Capacity	± 60 mm
Yaya trafiğine dayanıklıdır / Resistant for pedestrian traffic	

ZA 3150-120 H40

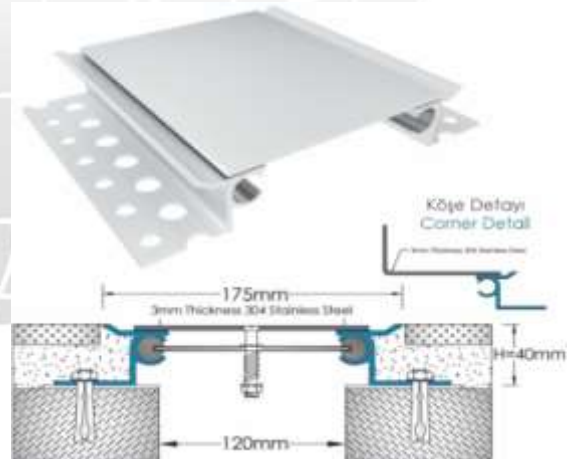

Teknik Özellikler / Technical Features

Dilatasyon Derz Açıklığı / Gap	120 mm
Yükseklik / Height	40 mm
Yüzey Genişliği / Surface Width	175 mm
Hareket Kapasitesi / Movement Capacity	± 60 mm
Hafif araç trafiğine dayanıklıdır / Resistant for light vehicle traffic	



KAFES GROUP
Ostim Osb Mh. 1568 Cd. No:51
06374 Yenimahalle/Ankara/Turkey
Tel.:+90 (0) 535 248 97 85
WEB.: www.kafesgroup.com
EMAIL.: info@kafesgroup.com

KAFES GROUP PROFILE SYSTEMS

12cm Açıklık İçin Zemin Dilatasyon Profilleri Floor Expansion Joint Profiles For 12cm Gaps

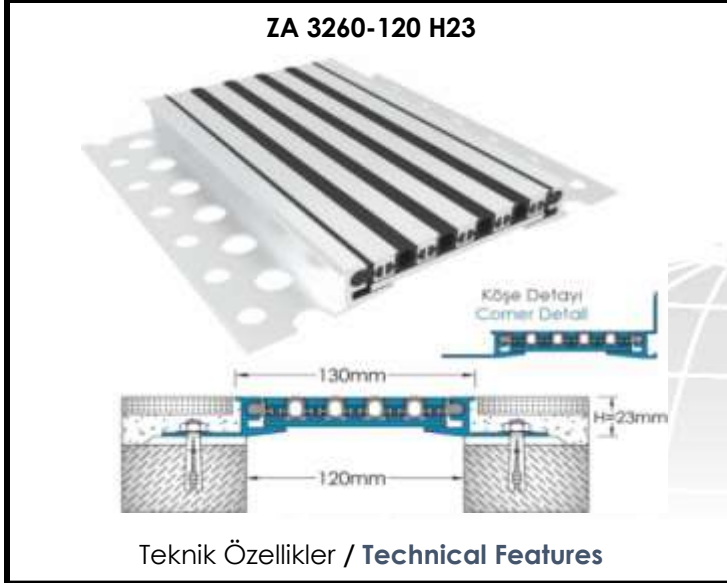

Dilatasyon Derz Açıklığı / Gap	120 mm
Yükseklik / Height	23 mm
Yüzey Genişliği / Surface Width	130 mm
Hareket Kapasitesi / Movement Capacity	± 20 mm
Yaya trafiğine dayanıklıdır / Resistant for pedestrian traffic	

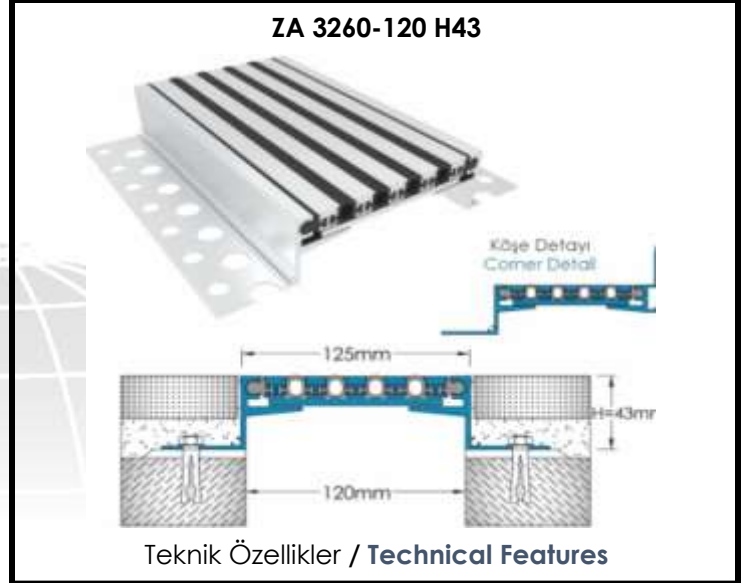

Dilatasyon Derz Açıklığı / Gap	120 mm
Yükseklik / Height	43 mm
Yüzey Genişliği / Surface Width	125 mm
Hareket Kapasitesi / Movement Capacity	± 20 mm
Yaya trafiğine dayanıklıdır / Resistant for pedestrian traffic	



Dilatasyon Derz Açıklığı / Gap	120 mm
Yükseklik / Height	28 mm
Yüzey Genişliği / Surface Width	125 mm
Hareket Kapasitesi / Movement Capacity	± 20 mm
Yaya trafiğine dayanıklıdır / Resistant for pedestrian traffic	

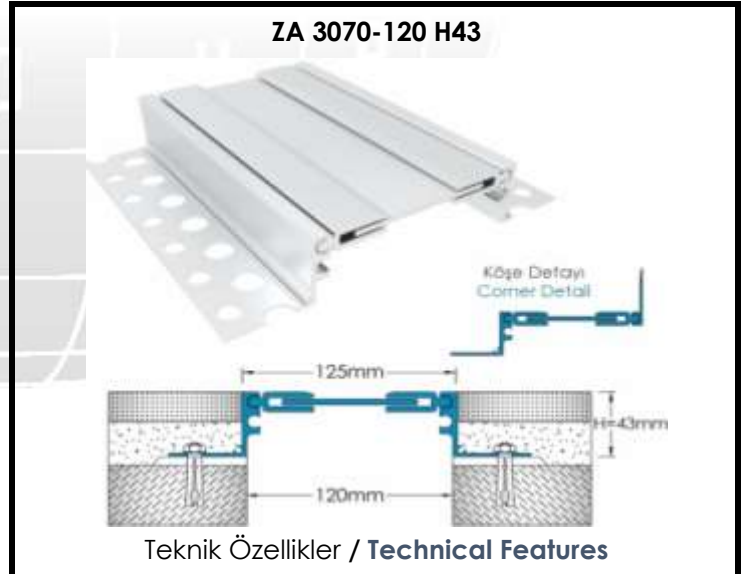

Dilatasyon Derz Açıklığı / Gap	120 mm
Yükseklik / Height	43 mm
Yüzey Genişliği / Surface Width	125 mm
Hareket Kapasitesi / Movement Capacity	± 20 mm
Yaya trafiğine dayanıklıdır / Resistant for pedestrian traffic	



KAFES GROUP
Ostim Osb Mh. 1568 Cd. No:51
06374 Yenimahalle/Ankara/Turkey
Tel.:+90 (0) 535 248 97 85
WEB.: www.kafesgroup.com
EMAIL.: info@kafesgroup.com

KAFES GROUP PROFILE SYSTEMS

12cm Açıklık İçin Zemin Dilatasyon Profilleri Floor Expansion Joint Profiles For 12cm Gaps

ZU 4050-120 H30

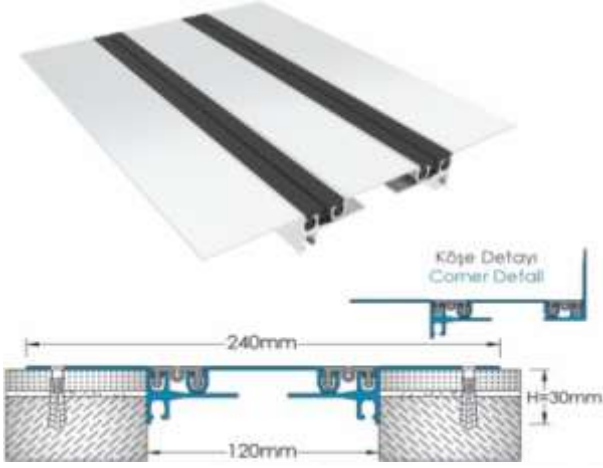

Teknik Özellikler / Technical Features

Dilatasyon Derz Açıklığı / Gap	120 mm
Yükseklik / Height	30 mm
Yüzey Genişliği / Surface Width	240 mm
Hareket Kapasitesi / Movement Capacity	± 14 mm
Yaya trafiğine dayanıklıdır / Resistant for pedestrian traffic	

ZU 4060-120 H23

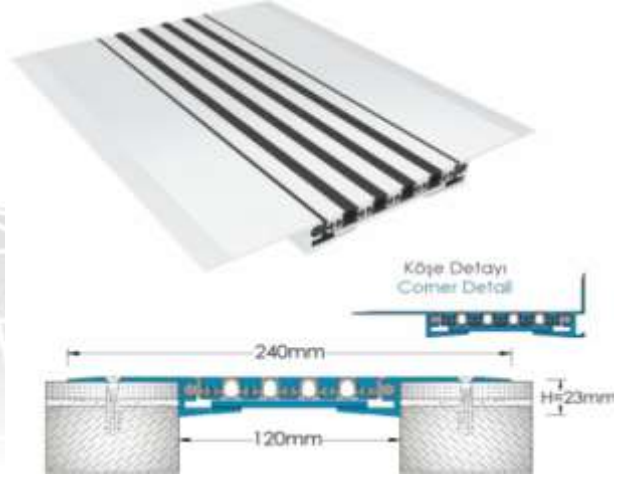

Teknik Özellikler / Technical Features

Dilatasyon Derz Açıklığı / Gap	120 mm
Yükseklik / Height	23 mm
Yüzey Genişliği / Surface Width	240 mm
Hareket Kapasitesi / Movement Capacity	± 20 mm
Yaya trafiğine dayanıklıdır / Resistant for pedestrian traffic	

ZU 4030-120 H14



Teknik Özellikler / Technical Features

Dilatasyon Derz Açıklığı / Gap	120 mm
Yükseklik / Height	24 mm
Yüzey Genişliği / Surface Width	265 mm
Hareket Kapasitesi / Movement Capacity	± 20 mm
1,5 ton FORKLİFT, 4 ton KAMYON yüküne dayanıklıdır Resistan to the 1,5 tons FORKLIFT and 4 tons TRUCK load	

ZU 4070-120 H28

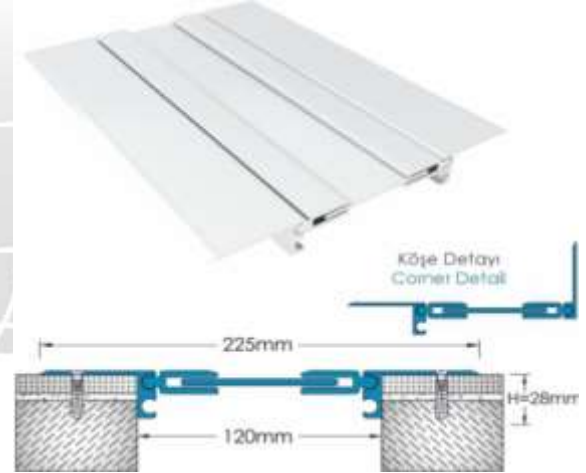

Teknik Özellikler / Technical Features

Dilatasyon Derz Açıklığı / Gap	120 mm
Yükseklik / Height	28 mm
Yüzey Genişliği / Surface Width	25 mm
Hareket Kapasitesi / Movement Capacity	± 20 mm
Yaya trafiğine dayanıklıdır / Resistant for pedestrian traffic	



KAFES GROUP
Ostim Osb Mh. 1568 Cd. No:51
06374 Yenimahalle/Ankara/Turkey
Tel.:+90 (0) 535 248 97 85
WEB.: www.kafesgroup.com
EMAIL.: info@kafesgroup.com

KAFES GROUP PROFILE SYSTEMS

15cm Açıklık İçin Duvar-Tavan Dilatasyon Profilleri Wall-Ceiling Expansion Joint Profiles For 15cm Gaps

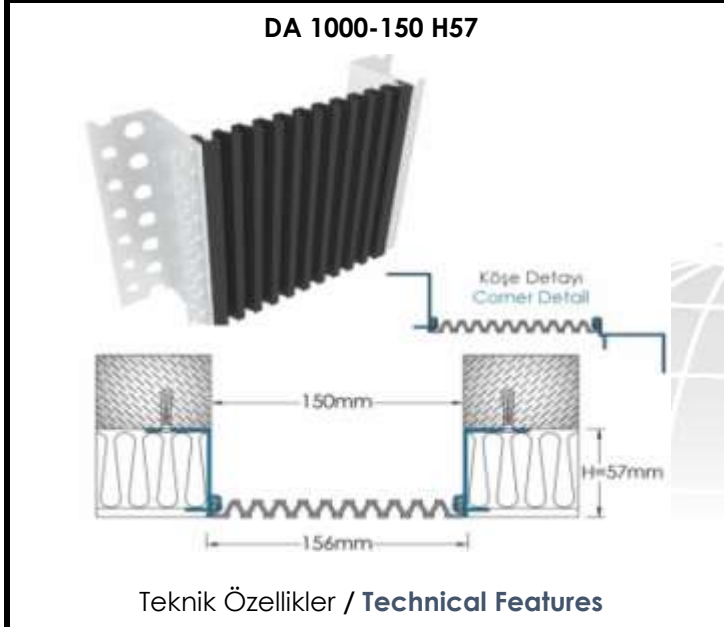

Dilatasyon Derz Açıklığı / Gap	150 mm
Yükseklik / Height	57 mm
Yüzey Genişliği / Surface Width	156 mm
Hareket Kapasitesi / Movement Capacity	± 75 mm

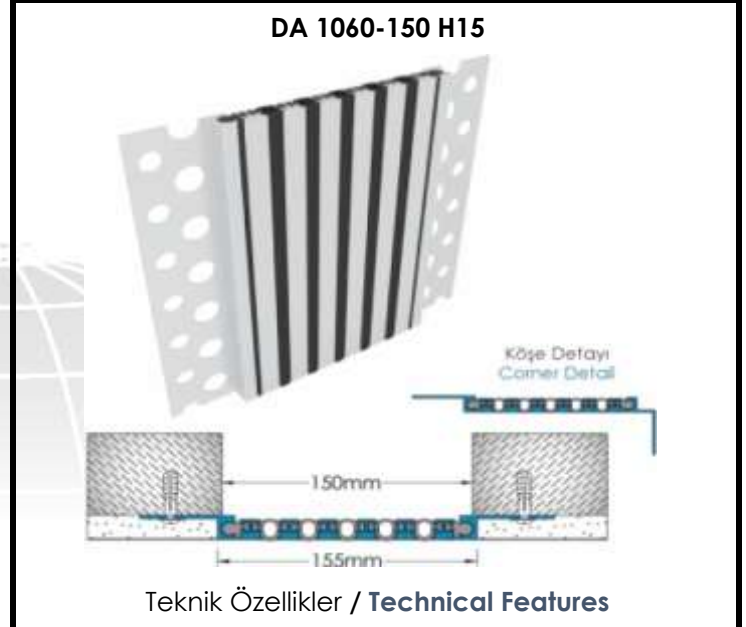

Dilatasyon Derz Açıklığı / Gap	150 mm
Yükseklik / Height	55 mm
Yüzey Genişliği / Surface Width	155 mm
Hareket Kapasitesi / Movement Capacity	± 25 mm

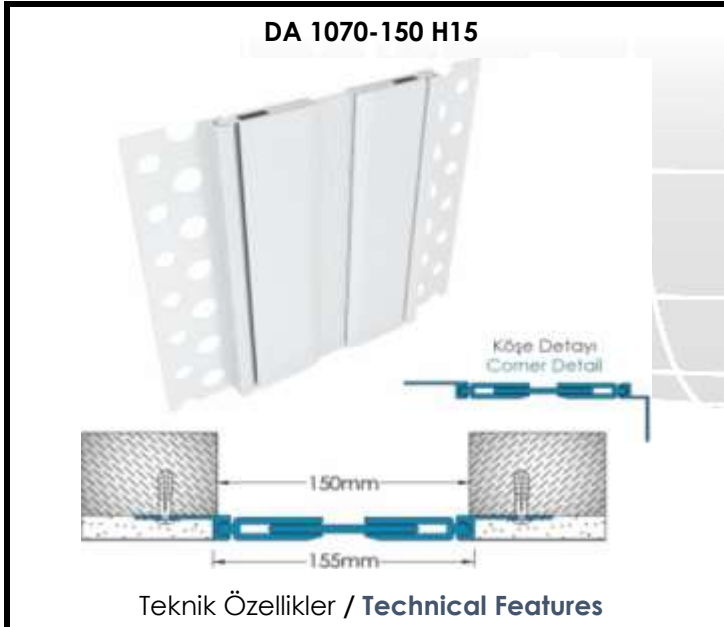

Dilatasyon Derz Açıklığı / Gap	150 mm
Yükseklik / Height	55 mm
Yüzey Genişliği / Surface Width	155 mm
Hareket Kapasitesi / Movement Capacity	± 25 mm

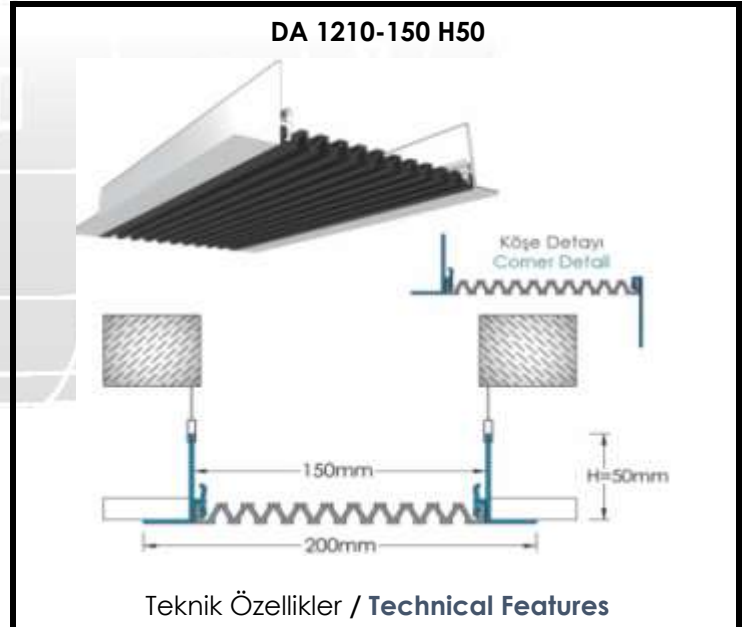

Dilatasyon Derz Açıklığı / Gap	150 mm
Yükseklik / Height	50 mm
Yüzey Genişliği / Surface Width	200 mm
Hareket Kapasitesi / Movement Capacity	± 75 mm



KAFES GROUP
Ostim Osb Mh. 1568 Cd. No:51
06374 Yenimahalle/Ankara/Turkey
Tel.:+90 (0) 535 248 97 85
WEB.: www.kafesgroup.com
EMAIL.: info@kafesgroup.com

KAFES GROUP PROFILE SYSTEMS

15cm Açıklık İçin Duvar-Tavan Dilatasyon Profilleri Wall-Ceiling Expansion Joint Profiles For 15cm Gaps

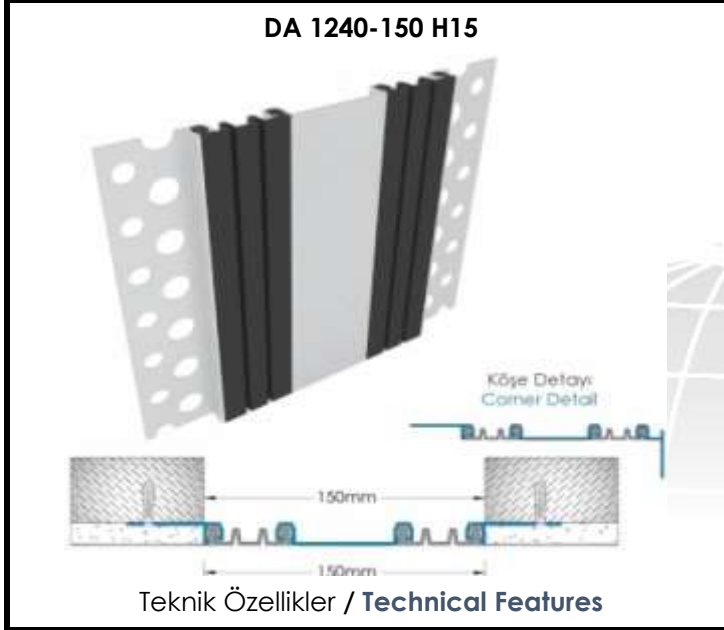

Dilatasyon Derz Açıklığı / Gap	150 mm
Yükseklik / Height	57 mm
Yüzey Genişliği / Surface Width	150 mm
Hareket Kapasitesi / Movement Capacity	± 50 mm

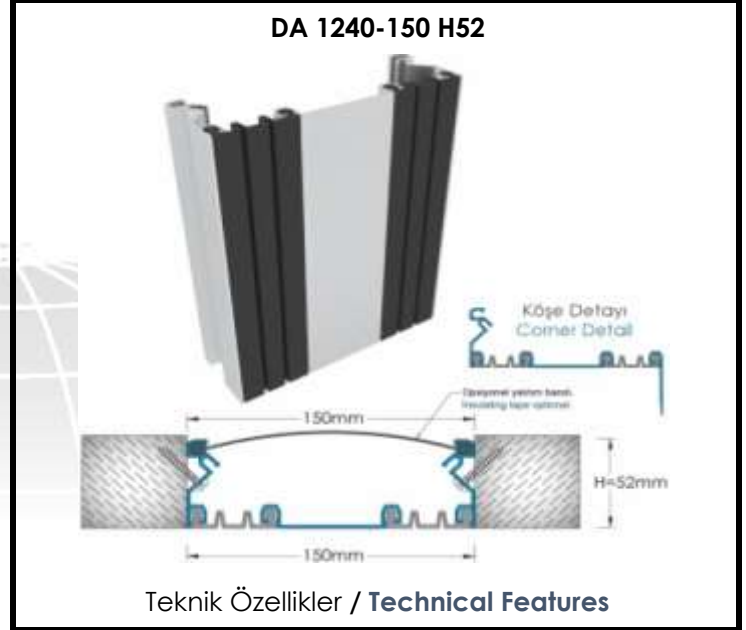

Dilatasyon Derz Açıklığı / Gap	150 mm
Yükseklik / Height	52 mm
Yüzey Genişliği / Surface Width	150 mm
Hareket Kapasitesi / Movement Capacity	± 50 mm

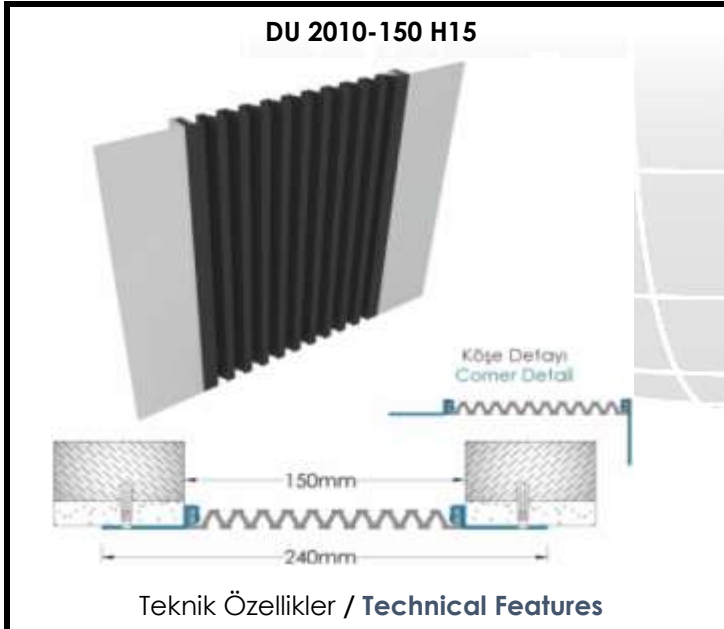

Dilatasyon Derz Açıklığı / Gap	150 mm
Yükseklik / Height	52 mm
Yüzey Genişliği / Surface Width	240 mm
Hareket Kapasitesi / Movement Capacity	± 75 mm

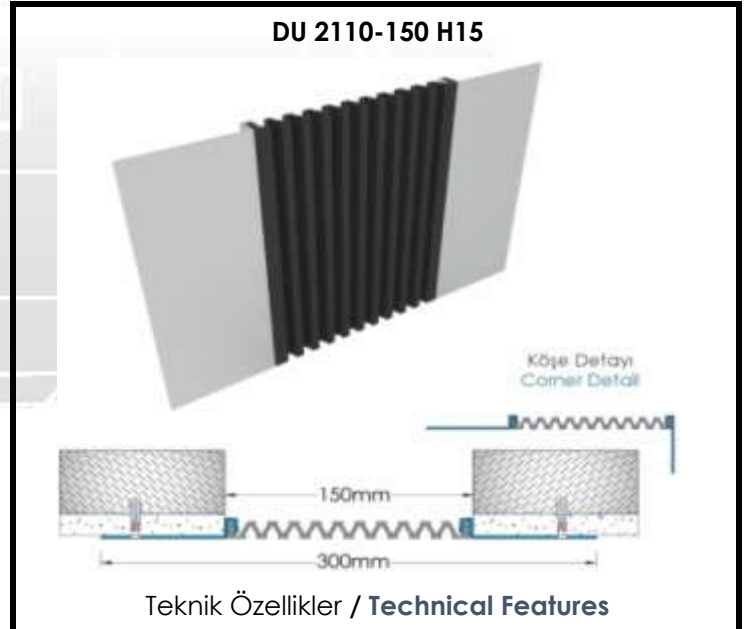

Dilatasyon Derz Açıklığı / Gap	150 mm
Yükseklik / Height	15 mm
Yüzey Genişliği / Surface Width	300 mm
Hareket Kapasitesi / Movement Capacity	± 75 mm



KAFES GROUP
Ostim Osb Mh. 1568 Cd. No:51
06374 Yenimahalle/Ankara/Turkey
Tel.:+90 (0) 535 248 97 85
WEB.: www.kafesgroup.com
EMAIL.: info@kafesgroup.com

KAFES GROUP PROFILE SYSTEMS

15cm Açıklık İçin Duvar-Tavan Dilatasyon Profilleri Wall-Ceiling Expansion Joint Profiles For 15cm Gaps

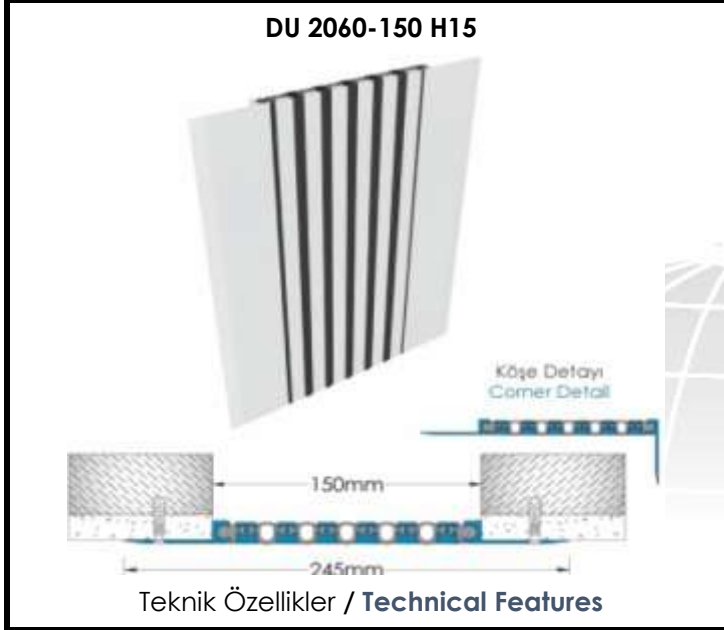

Dilatasyon Derz Açıklığı / Gap	150 mm
Yükseklik / Height	15 mm
Yüzey Genişliği / Surface Width	245 mm
Hareket Kapasitesi / Movement Capacity	± 25 mm

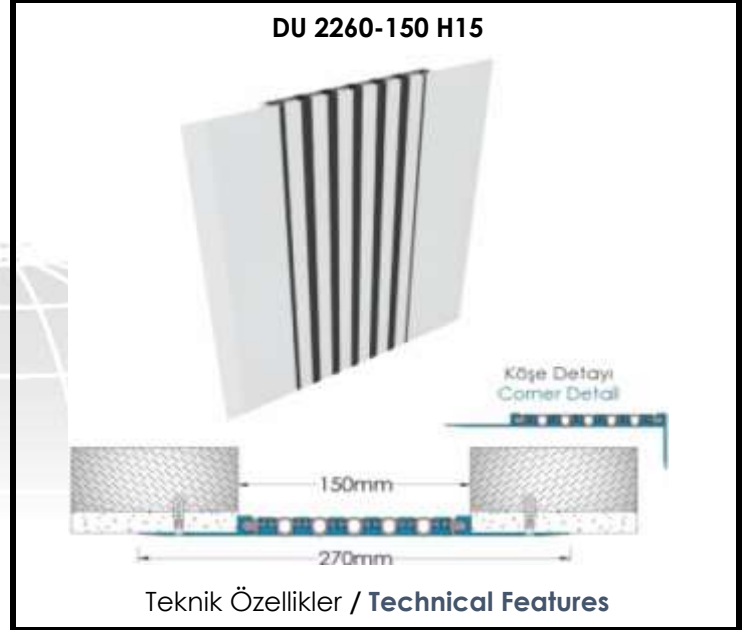

Dilatasyon Derz Açıklığı / Gap	150 mm
Yükseklik / Height	15 mm
Yüzey Genişliği / Surface Width	270 mm
Hareket Kapasitesi / Movement Capacity	± 25 mm

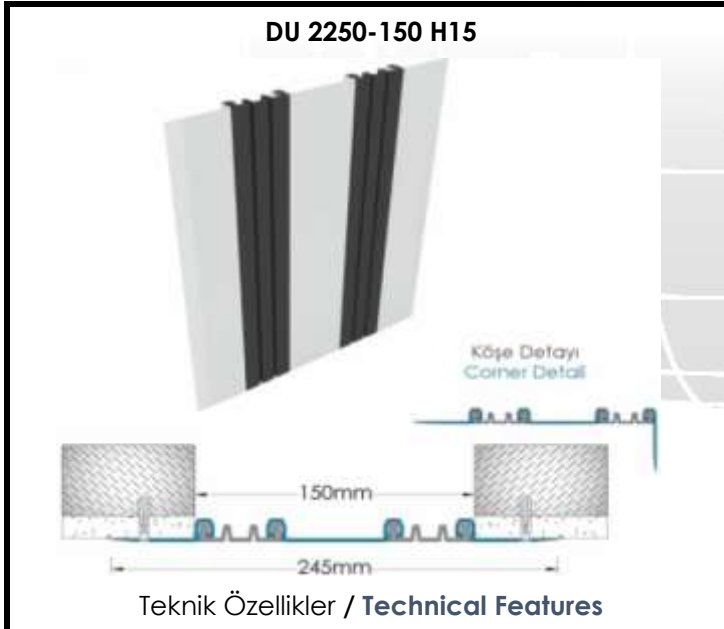

Dilatasyon Derz Açıklığı / Gap	150 mm
Yükseklik / Height	15 mm
Yüzey Genişliği / Surface Width	245 mm
Hareket Kapasitesi / Movement Capacity	± 50 mm

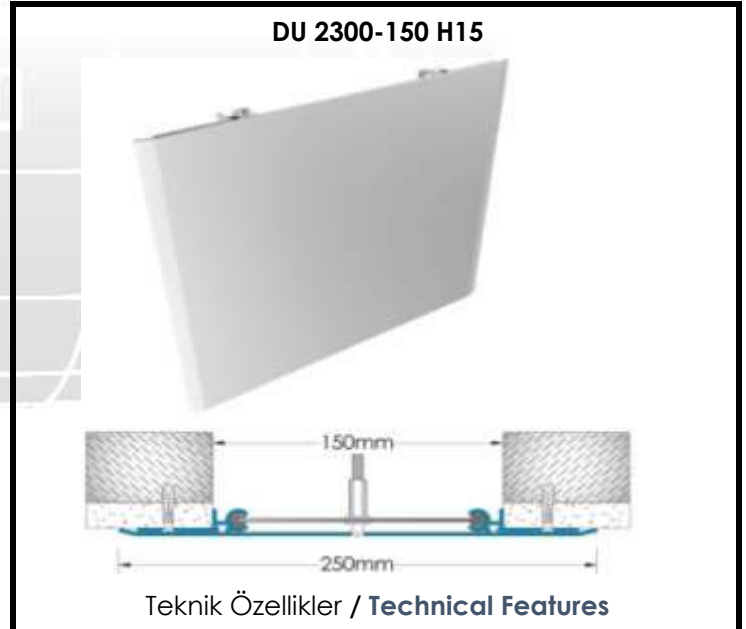

Dilatasyon Derz Açıklığı / Gap	150 mm
Yükseklik / Height	15 mm
Yüzey Genişliği / Surface Width	250 mm
Hareket Kapasitesi / Movement Capacity	± 75 mm



KAFES GROUP
Ostim Osb Mh. 1568 Cd. No:51
06374 Yenimahalle/Ankara/Turkey
Tel.:+90 (0) 535 248 97 85
WEB.: www.kafesgroup.com
EMAIL.: info@kafesgroup.com

KAFES GROUP PROFILE SYSTEMS

15cm Açıklık İçin Duvar-Tavan Dilatasyon Profilleri Wall-Ceiling Expansion Joint Profiles For 15cm Gaps

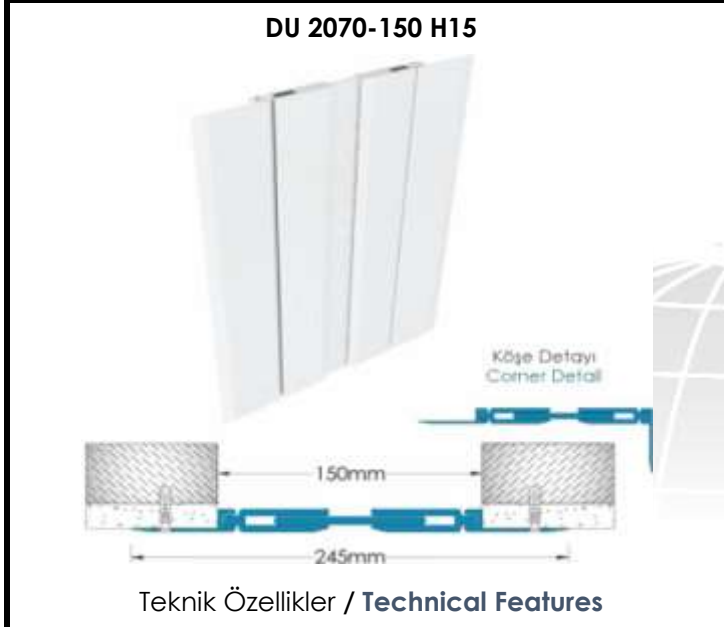

Dilatasyon Derz Açıklığı / Gap	150 mm
Yükseklik / Height	15 mm
Yüzey Genişliği / Surface Width	245 mm
Hareket Kapasitesi / Movement Capacity	± 25 mm

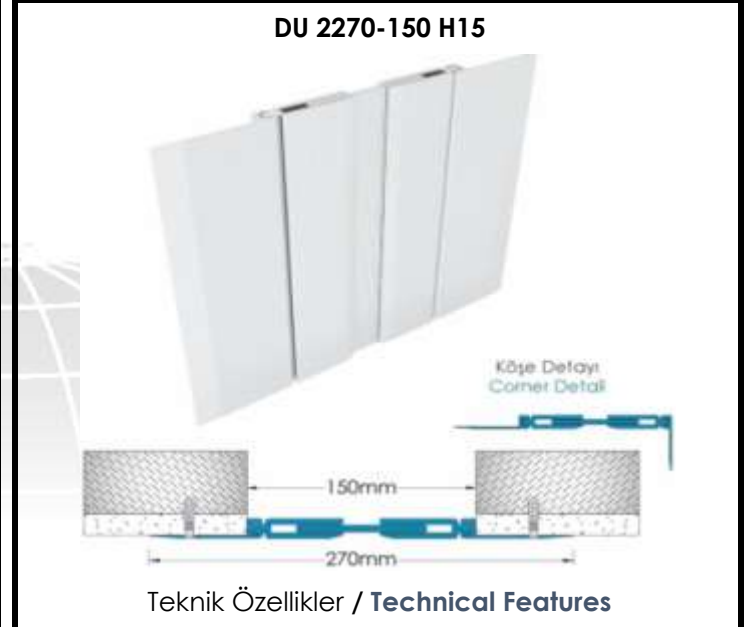

Dilatasyon Derz Açıklığı / Gap	150 mm
Yükseklik / Height	15 mm
Yüzey Genişliği / Surface Width	270 mm
Hareket Kapasitesi / Movement Capacity	± 25 mm

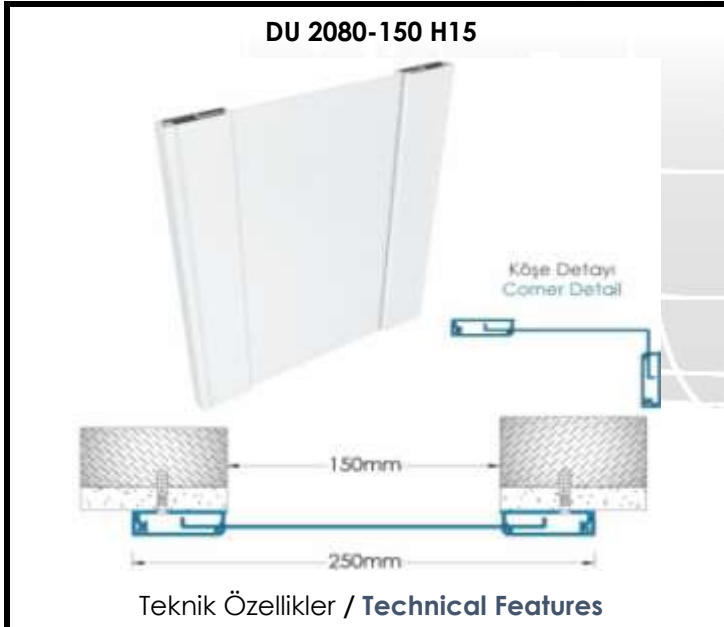

Dilatasyon Derz Açıklığı / Gap	150 mm
Yükseklik / Height	15 mm
Yüzey Genişliği / Surface Width	250 mm
Hareket Kapasitesi / Movement Capacity	± 65 mm

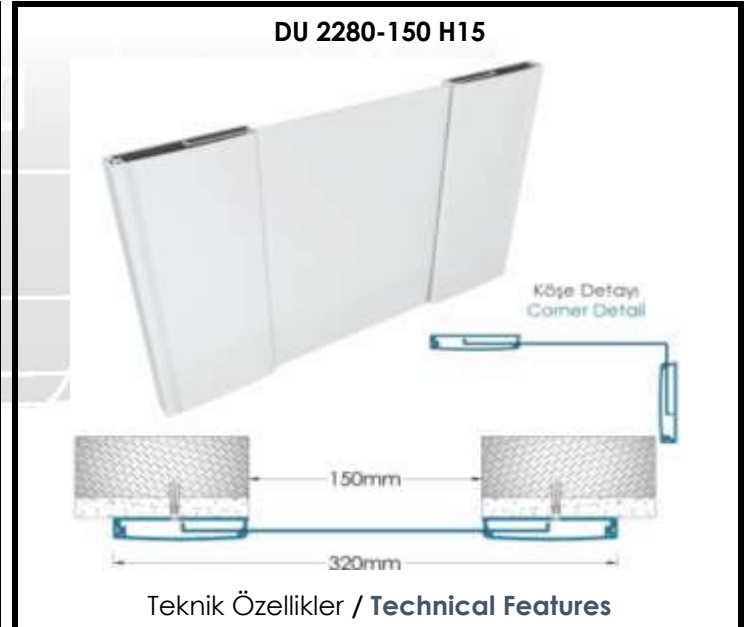

Dilatasyon Derz Açıklığı / Gap	150 mm
Yükseklik / Height	15 mm
Yüzey Genişliği / Surface Width	320 mm
Hareket Kapasitesi / Movement Capacity	± 75 mm



KAFES GROUP
Ostim Osb Mh. 1568 Cd. No:51
06374 Yenimahalle/Ankara/Turkey
Tel.:+90 (0) 535 248 97 85
WEB.: www.kafesgroup.com
EMAIL.: info@kafesgroup.com

KAFES GROUP PROFILE SYSTEMS

15cm Açıklık İçin Zemin Dilatasyon Profilleri Floor Expansion Joint Profiles For 3cm Gaps

ZA 3000-150 H45

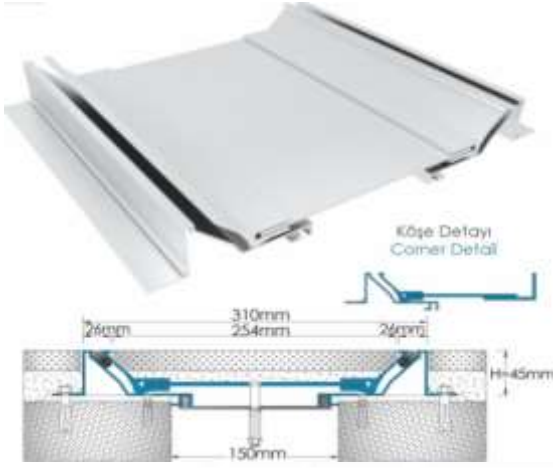

Teknik Özellikler / Technical Features

Dilatasyon Derz Açıklığı / Gap	150 mm
Yükseklik / Height	45 mm
Yüzey Genişliği / Surface Width	310 mm
Hareket Kapasitesi / Movement Capacity	± 75 mm
Yaya trafiğine dayanıklıdır / Resistant for pedestrian traffic	

ZA 3050-150 H70

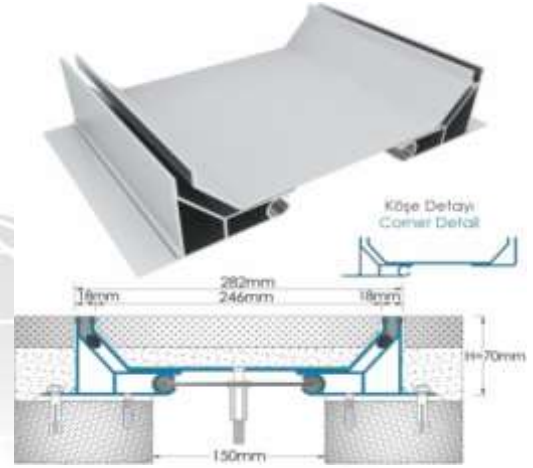

Teknik Özellikler / Technical Features

Dilatasyon Derz Açıklığı / Gap	150 mm
Yükseklik / Height	70 mm
Yüzey Genişliği / Surface Width	282 mm
Hareket Kapasitesi / Movement Capacity	± 75 mm
Yaya trafiğine dayanıklıdır / Resistant for pedestrian traffic	

ZA 3100-150 H40

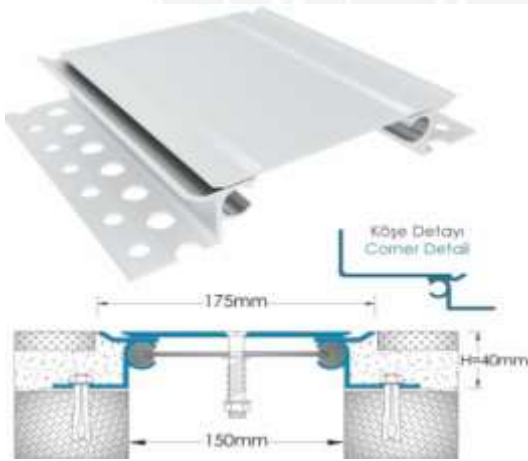

Teknik Özellikler / Technical Features

Dilatasyon Derz Açıklığı / Gap	150 mm
Yükseklik / Height	40 mm
Yüzey Genişliği / Surface Width	175 mm
Hareket Kapasitesi / Movement Capacity	± 60 mm
Yaya trafiğine dayanıklıdır / Resistant for pedestrian traffic	

ZA 3150-150 H40

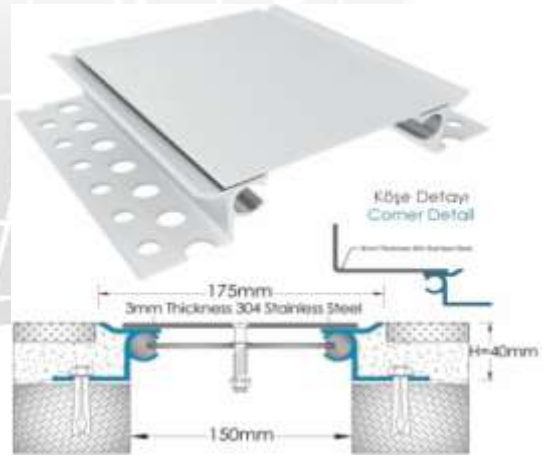

Teknik Özellikler / Technical Features

Dilatasyon Derz Açıklığı / Gap	150 mm
Yükseklik / Height	40 mm
Yüzey Genişliği / Surface Width	175 mm
Hareket Kapasitesi / Movement Capacity	± 60 mm
Hafif araç trafiğine dayanıklıdır / Resistant for light vehicle traffic	



KAFES GROUP
Ostim Osb Mh. 1568 Cd. No:51
06374 Yenimahalle/Ankara/Turkey
Tel.:+90 (0) 535 248 97 85
WEB.: www.kafesgroup.com
EMAIL.: info@kafesgroup.com

KAFES GROUP PROFILE SYSTEMS

15cm Açıklık İçin Zemin Dilatasyon Profilleri Floor Expansion Joint Profiles For 3cm Gaps

ZA 3040-150 H30

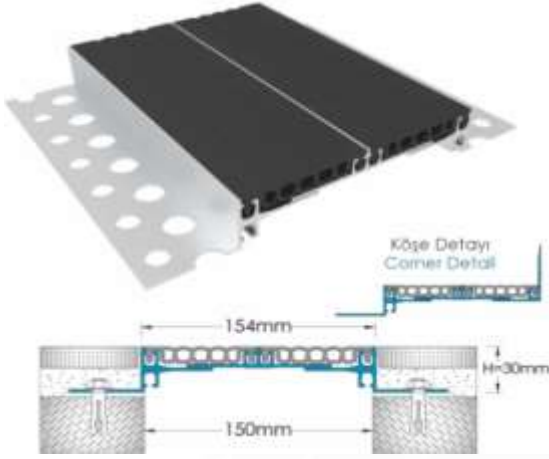

Teknik Özellikler / Technical Features

Dilatasyon Derz Açıklığı / Gap	150 mm
Yükseklik / Height	30 mm
Yüzey Genişliği / Surface Width	145 mm
Hareket Kapasitesi / Movement Capacity	± 30 mm
Yaya trafiğine dayanıklıdır / Resistant for pedestrian traffic	

ZA 3130-150 H50

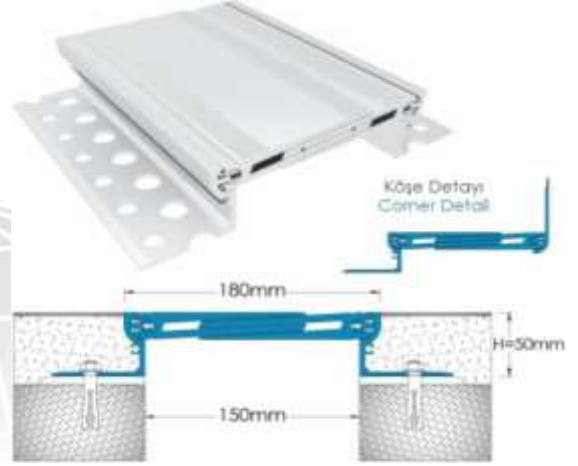

Teknik Özellikler / Technical Features

Dilatasyon Derz Açıklığı / Gap	150 mm
Yükseklik / Height	50 mm
Yüzey Genişliği / Surface Width	180 mm
Hareket Kapasitesi / Movement Capacity	± 20 mm
2,5 ton FORKLİFT, 9 ton KAMYON yüküne dayanıklıdır Resistant to the 2,5 tons FORKLIFT and 9 tons TRUCK load	

ZA 3260-150 H23

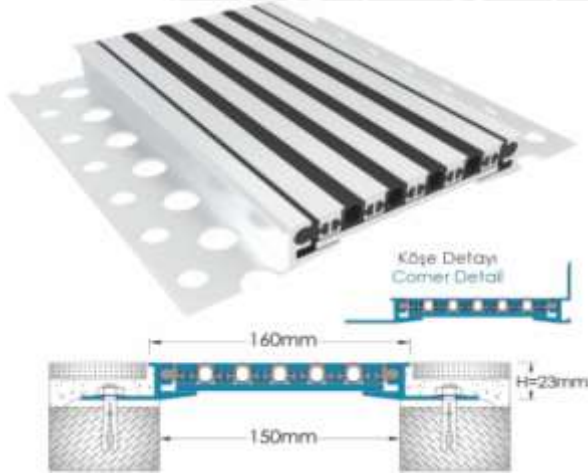

Teknik Özellikler / Technical Features

Dilatasyon Derz Açıklığı / Gap	150 mm
Yükseklik / Height	23 mm
Yüzey Genişliği / Surface Width	160 mm
Hareket Kapasitesi / Movement Capacity	± 25 mm
Yaya trafiğine dayanıklıdır / Resistant for pedestrian traffic	

ZA 3260-150 H50

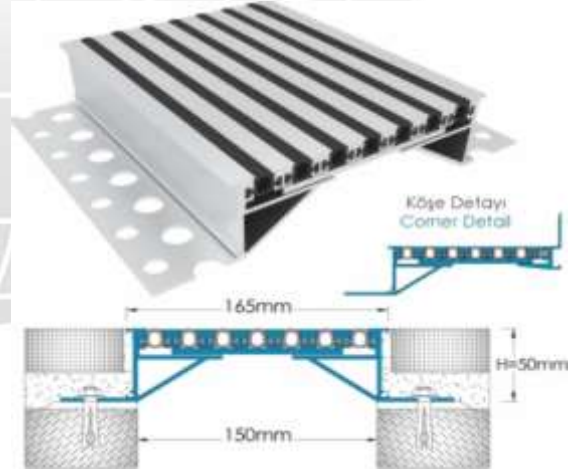

Teknik Özellikler / Technical Features

Dilatasyon Derz Açıklığı / Gap	150 mm
Yükseklik / Height	50 mm
Yüzey Genişliği / Surface Width	165 mm
Hareket Kapasitesi / Movement Capacity	± 25 mm
Yaya trafiğine dayanıklıdır / Resistant for pedestrian traffic	



KAFES GROUP
Ostim Osb Mh. 1568 Cd. No:51
06374 Yenimahalle/Ankara/Turkey
Tel.:+90 (0) 535 248 97 85
WEB.: www.kafesgroup.com
EMAIL.: info@kafesgroup.com

KAFES GROUP PROFILE SYSTEMS

15cm Açıklık İçin Zemin Dilatasyon Profilleri Floor Expansion Joint Profiles For 3cm Gaps

ZA 3070-150 H28

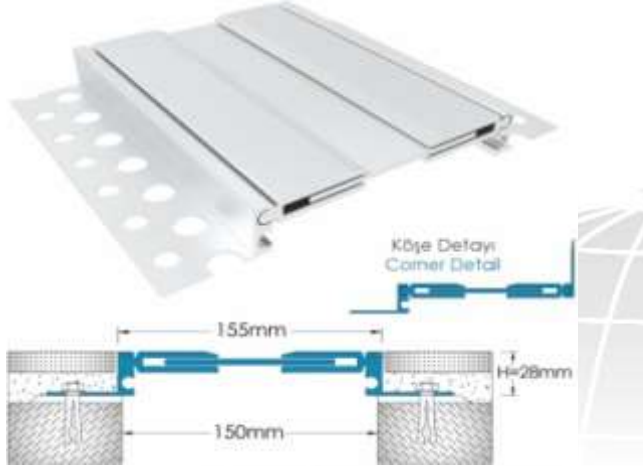

Teknik Özellikler / Technical Features

Dilatasyon Derz Açıklığı / Gap	150 mm
Yükseklik / Height	28 mm
Yüzey Genişliği / Surface Width	155 mm
Hareket Kapasitesi / Movement Capacity	± 25 mm
Yaya trafiğine dayanıklıdır / Resistant for pedestrian traffic	

ZA 3070-150 H43

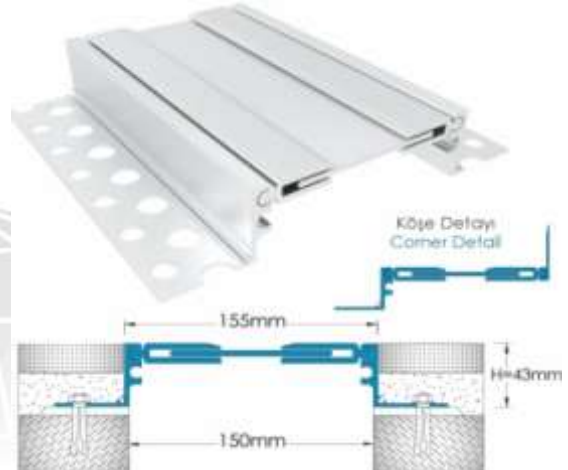

Teknik Özellikler / Technical Features

Dilatasyon Derz Açıklığı / Gap	150 mm
Yükseklik / Height	43 mm
Yüzey Genişliği / Surface Width	155 mm
Hareket Kapasitesi / Movement Capacity	± 25 mm
Yaya trafiğine dayanıklıdır / Resistant for pedestrian traffic	

ZU 4070-150 H28

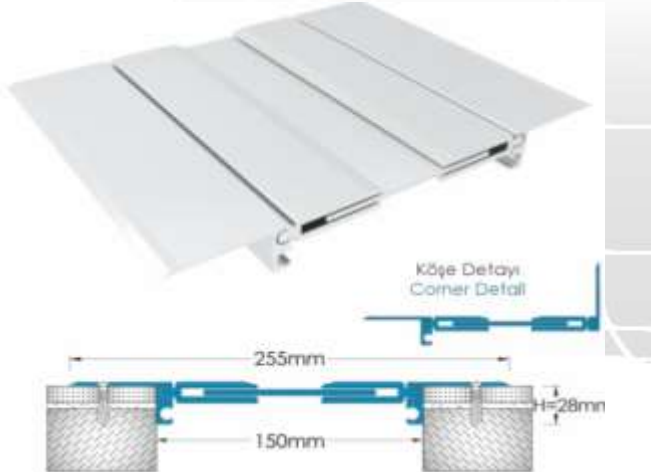

Teknik Özellikler / Technical Features

Dilatasyon Derz Açıklığı / Gap	150 mm
Yükseklik / Height	28 mm
Yüzey Genişliği / Surface Width	255 mm
Hareket Kapasitesi / Movement Capacity	± 25 mm
Yaya trafiğine dayanıklıdır / Resistant for pedestrian traffic	

ZU 4130-150 H20

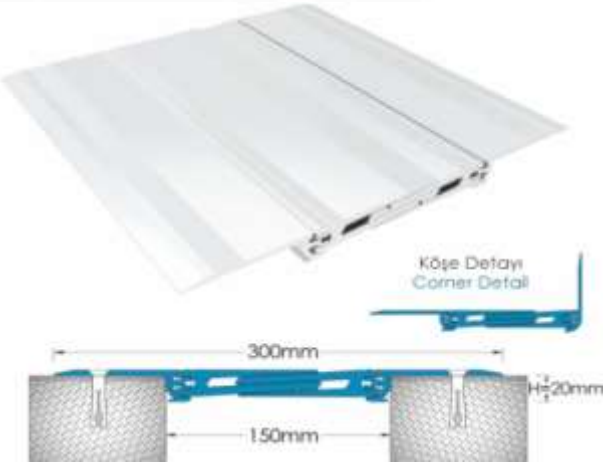

Teknik Özellikler / Technical Features

Dilatasyon Derz Açıklığı / Gap	150 mm
Yükseklik / Height	20 mm
Yüzey Genişliği / Surface Width	300 mm
Hareket Kapasitesi / Movement Capacity	± 25 mm
1,5 ton FORKLİFT, 3,5 ton KAMYON yüküne dayanıklıdır Resistant to the 1,5 tons FORKLIFT and 3,5 tons TRUCK load	



KAFES GROUP
Ostim Osb Mh. 1568 Cd. No:51
06374 Yenimahalle/Ankara/Turkey
Tel.:+90 (0) 535 248 97 85
WEB.: www.kafesgroup.com
EMAIL.: info@kafesgroup.com

KAFES GROUP PROFILE SYSTEMS

15cm Açıklık İçin Zemin Dilatasyon Profilleri Floor Expansion Joint Profiles For 3cm Gaps

ZU 4040-150 H30

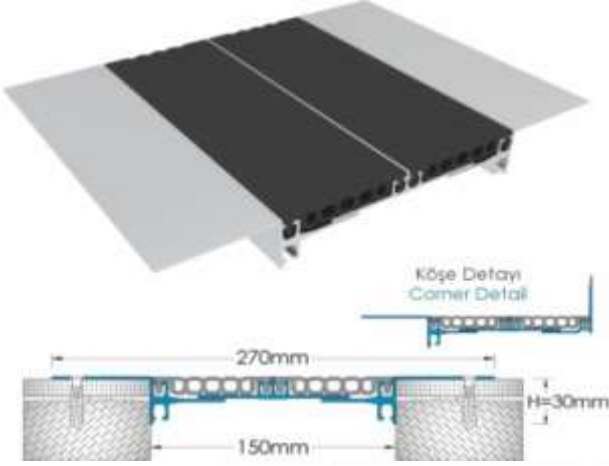

Teknik Özellikler / Technical Features

Dilatasyon Derz Açıklığı / Gap	150 mm
Yükseklik / Height	30 mm
Yüzey Genişliği / Surface Width	270 mm
Hareket Kapasitesi / Movement Capacity	± 30 mm
Yaya trafiğine dayanıklıdır / Resistant for pedestrian traffic	

ZU 4080-150 H35

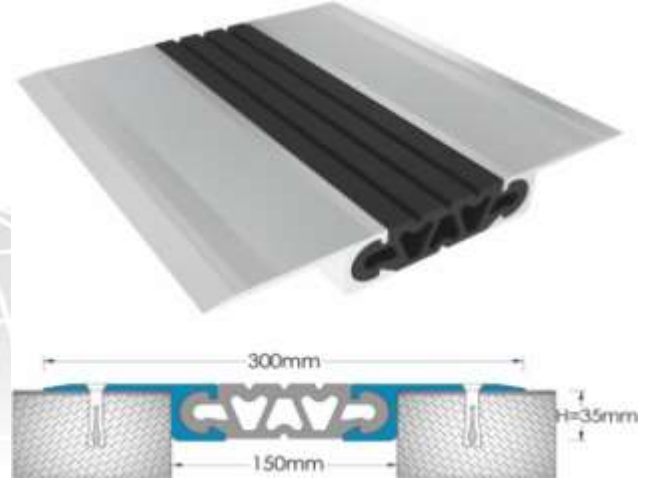

Teknik Özellikler / Technical Features

Dilatasyon Derz Açıklığı / Gap	150 mm
Yükseklik / Height	35 mm
Yüzey Genişliği / Surface Width	300 mm
Hareket Kapasitesi / Movement Capacity	± 25 mm
30 ton KAMYON yüküne dayanıklıdır / Resistant to 30 tons TRUCK load	

ZU 4060-150 H24

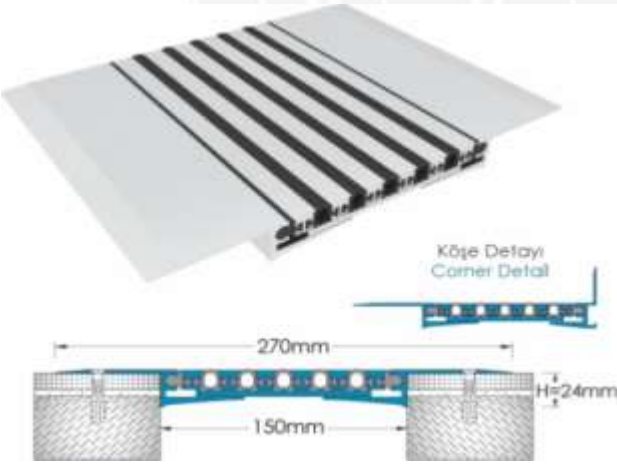

Teknik Özellikler / Technical Features

Dilatasyon Derz Açıklığı / Gap	150 mm
Yükseklik / Height	24 mm
Yüzey Genişliği / Surface Width	270 mm
Hareket Kapasitesi / Movement Capacity	± 25 mm
Yaya trafiğine dayanıklıdır / Resistant for pedestrian traffic	

ZU 4300-150 H15

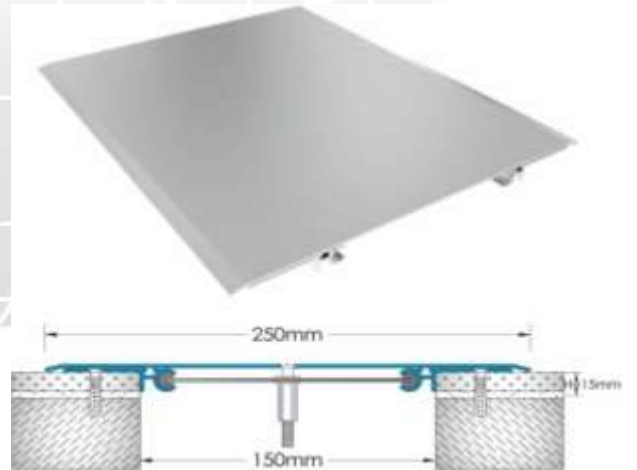

Teknik Özellikler / Technical Features

Dilatasyon Derz Açıklığı / Gap	150 mm
Yükseklik / Height	15 mm
Yüzey Genişliği / Surface Width	250 mm
Hareket Kapasitesi / Movement Capacity	± 75 mm
Yaya trafiğine dayanıklıdır / Resistant for pedestrian traffic	



KAFES GROUP
Ostim Osb Mh. 1568 Cd. No:51
06374 Yenimahalle/Ankara/Turkey
Tel.:+90 (0) 535 248 97 85
WEB.: www.kafesgroup.com
EMAIL.: info@kafesgroup.com

KAFES GROUP PROFILE SYSTEMS

20cm Açıklık İçin Duvar-Tavan Dilatasyon Profilleri Wall-Ceiling Expansion Joint Profiles For 20cm Gaps

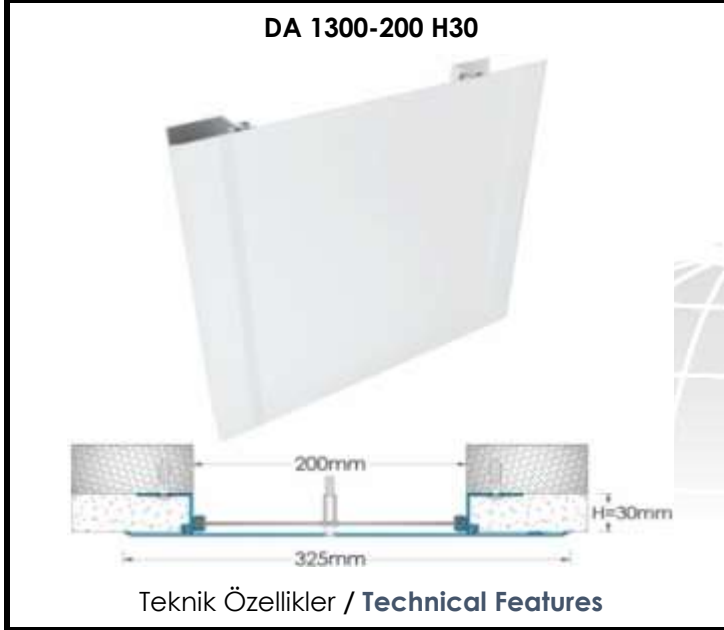

Dilatasyon Derz Açıklığı / Gap	200 mm
Yükseklik / Height	30 mm
Yüzey Genişliği / Surface Width	325 mm
Hareket Kapasitesi / Movement Capacity	± 100 mm

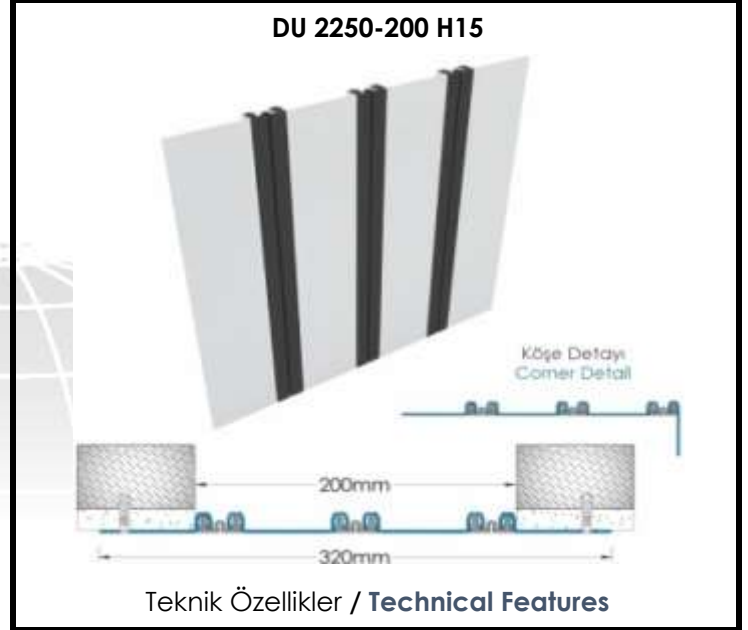

Dilatasyon Derz Açıklığı / Gap	200 mm
Yükseklik / Height	15 mm
Yüzey Genişliği / Surface Width	320 mm
Hareket Kapasitesi / Movement Capacity	+50/-40 mm

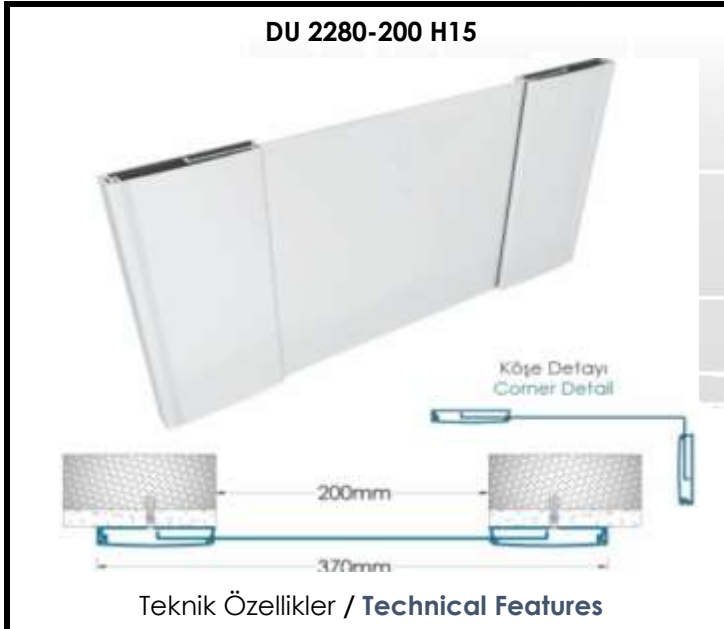

Dilatasyon Derz Açıklığı / Gap	200 mm
Yükseklik / Height	15 mm
Yüzey Genişliği / Surface Width	370 mm
Hareket Kapasitesi / Movement Capacity	± 75 mm



Dilatasyon Derz Açıklığı / Gap	200 mm
Yükseklik / Height	15 mm
Yüzey Genişliği / Surface Width	300 mm
Hareket Kapasitesi / Movement Capacity	± 100 mm



KAFES GROUP
Ostim Osb Mh. 1568 Cd. No:51
06374 Yenimahalle/Ankara/Turkey
Tel.:+90 (0) 535 248 97 85
WEB.: www.kafesgroup.com
EMAIL.: info@kafesgroup.com

KAFES GROUP PROFILE SYSTEMS

20cm Açıklık İçin Zemin Dilatasyon Profilleri Floor Expansion Joint Profiles For 20cm Gaps

ZA 3000-200 H45

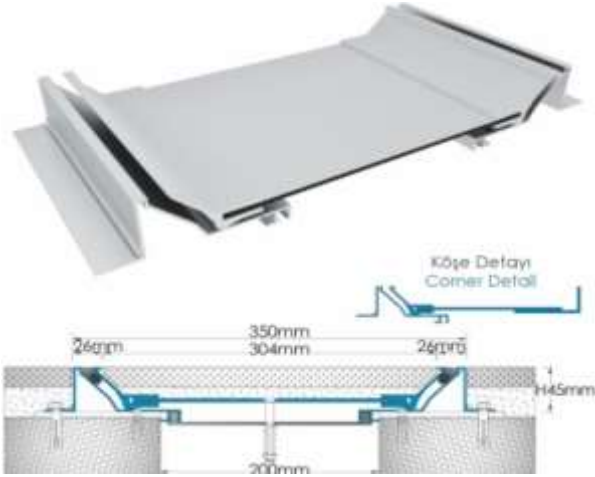

Teknik Özellikler / Technical Features

Dilatasyon Derz Açıklığı / Gap	200 mm
Yükseklik / Height	45 mm
Yüzey Genişliği / Surface Width	350 mm
Hareket Kapasitesi / Movement Capacity	± 100 mm
Yaya trafiğine dayanıklıdır / Resistant for pedestrian traffic	

ZA 3150-200 H40

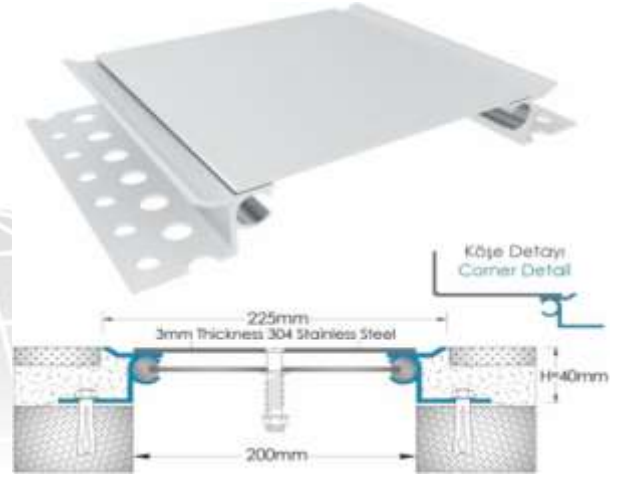

Teknik Özellikler / Technical Features

Dilatasyon Derz Açıklığı / Gap	200 mm
Yükseklik / Height	40 mm
Yüzey Genişliği / Surface Width	225 mm
Hareket Kapasitesi / Movement Capacity	+75/-100 mm
Hafif araç trafiğine dayanıklıdır / Resistant for light vehicle traffic	

ZA 3130-200 H50

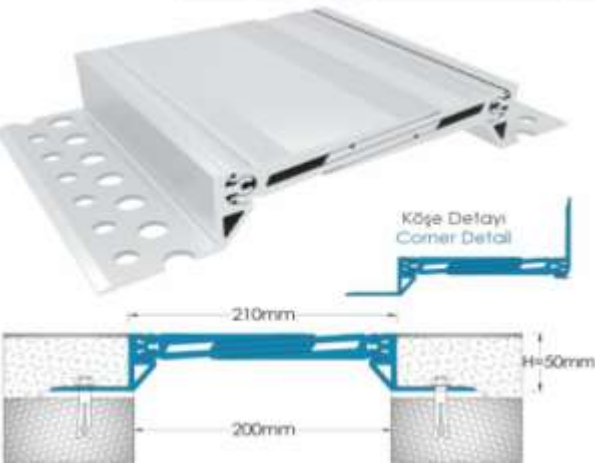

Teknik Özellikler / Technical Features

Dilatasyon Derz Açıklığı / Gap	200 mm
Yükseklik / Height	50 mm
Yüzey Genişliği / Surface Width	210 mm
Hareket Kapasitesi / Movement Capacity	± 30 mm
2,5 ton FORKLİFT, 12 ton KAMYON yüküne dayanıklıdır Resistan to the 2,5 tons FORKLIFT and 12 tons TRUCK load	

ZA 3260-200 H50

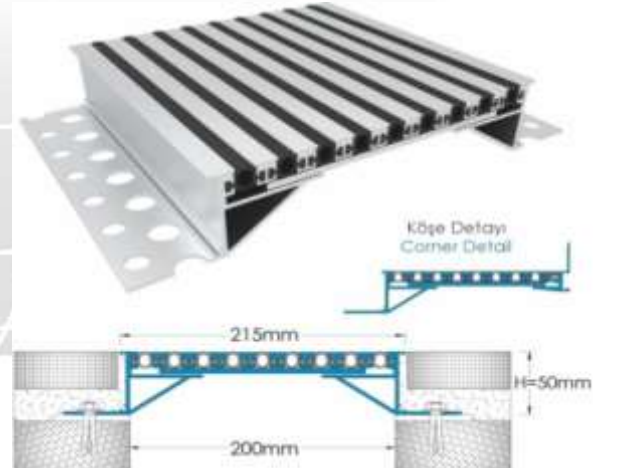

Teknik Özellikler / Technical Features

Dilatasyon Derz Açıklığı / Gap	200 mm
Yükseklik / Height	50 mm
Yüzey Genişliği / Surface Width	215 mm
Hareket Kapasitesi / Movement Capacity	± 30 mm
Yaya trafiğine dayanıklıdır / Resistant for pedestrian traffic	



KAFES GROUP
Ostim Osb Mh. 1568 Cd. No:51
06374 Yenimahalle/Ankara/Turkey
Tel.:+90 (0) 535 248 97 85
WEB.: www.kafesgroup.com
EMAIL.: info@kafesgroup.com

KAFES GROUP PROFILE SYSTEMS

20cm Açıklık İçin Zemin Dilatasyon Profilleri Floor Expansion Joint Profiles For 20cm Gaps

ZU 4060-200 H24

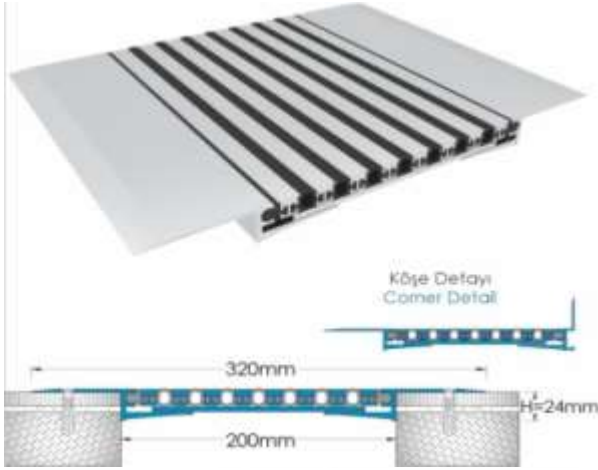

Teknik Özellikler / Technical Features

Dilatasyon Derz Açıklığı / Gap	200 mm
Yükseklik / Height	24 mm
Yüzey Genişliği / Surface Width	320 mm
Hareket Kapasitesi / Movement Capacity	± 30 mm
Yaya trafiğine dayanıklıdır / Resistant for pedestrian traffic	

ZU 4060-200 H28

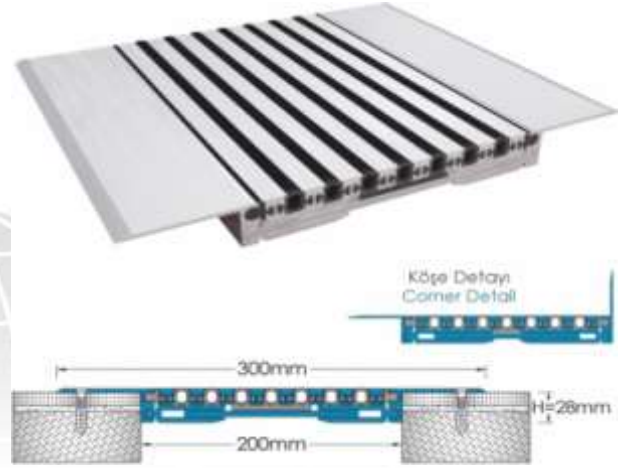

Teknik Özellikler / Technical Features

Dilatasyon Derz Açıklığı / Gap	200 mm
Yükseklik / Height	28 mm
Yüzey Genişliği / Surface Width	300 mm
Hareket Kapasitesi / Movement Capacity	± 30 mm
Yaya trafiğine dayanıklıdır / Resistant for pedestrian traffic	

ZU 4130-200 H22



Teknik Özellikler / Technical Features

Dilatasyon Derz Açıklığı / Gap	200 mm
Yükseklik / Height	22 mm
Yüzey Genişliği / Surface Width	365 mm
Hareket Kapasitesi / Movement Capacity	+40/-15 mm
1,5 ton FORKLİFT, 3,5 ton KAMYON yüküne dayanıklıdır Resistan to the 1,5 tons FORKLIFT and 3,5 tons TRUCK load	

ZU 4300-200 H15

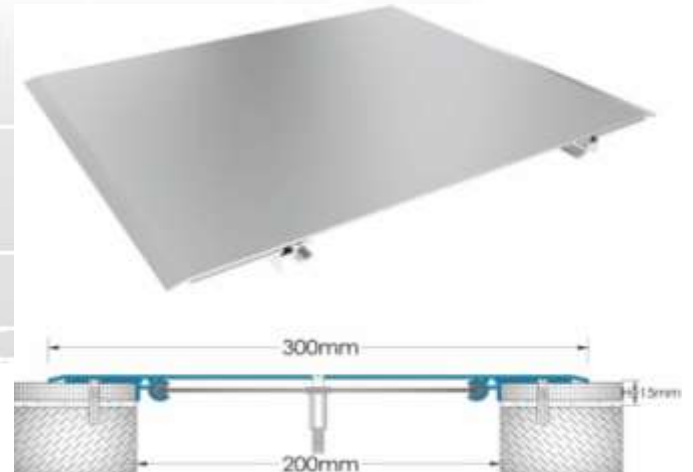

Teknik Özellikler / Technical Features

Dilatasyon Derz Açıklığı / Gap	200 mm
Yükseklik / Height	15 mm
Yüzey Genişliği / Surface Width	300 mm
Hareket Kapasitesi / Movement Capacity	± 100 mm
Yaya trafiğine dayanıklıdır / Resistant for pedestrian traffic	



KAFES GROUP
Ostim Osb Mh. 1568 Cd. No:51
06374 Yenimahalle/Ankara/Turkey
Tel.:+90 (0) 535 248 97 85
WEB.: www.kafesgroup.com
EMAIL.: info@kafesgroup.com

KAFES GROUP PROFILE SYSTEMS

Su Yalıtımlı Dilatasyon Profilleri Wateright Expansion Joint Profiles

ZA 3090-060 H60

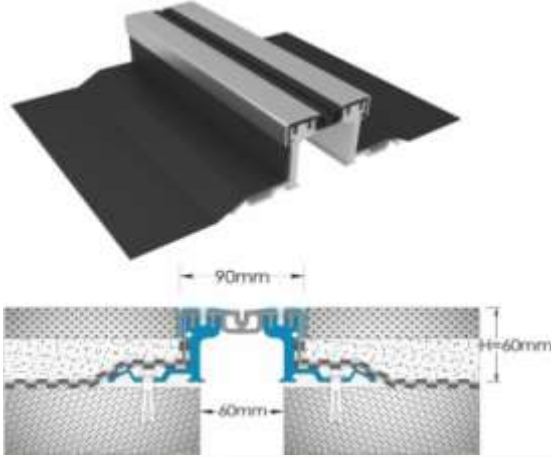

Teknik Özellikler / **Technical Features**

Dilatasyon Derz Açıklığı / Gap	60 mm
Yükseklik / Height	60 mm
Yüzey Genişliği / Surface Width	90 mm
Hareket Kapasitesi / Movement Capacity	± 20 mm
6 ton FORKLİFT, 15 ton KAMYON yüküne dayanıklıdır Resistan to the 6 tons FORKLIFT and 15 tons TRUCK load	

ZA 3290-060 H60

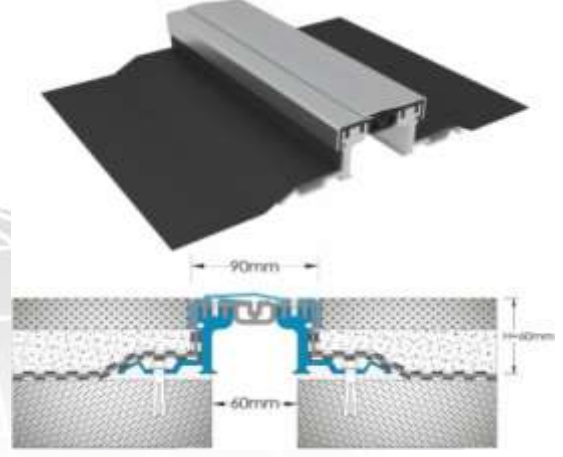

Teknik Özellikler / **Technical Features**

Dilatasyon Derz Açıklığı / Gap	60 mm
Yükseklik / Height	60 mm
Yüzey Genişliği / Surface Width	90 mm
Hareket Kapasitesi / Movement Capacity	± 20 mm
6 ton FORKLİFT, 15 ton KAMYON yüküne dayanıklıdır Resistan to the 6 tons FORKLIFT and 15 tons TRUCK load	

ZA 3090-060 H80

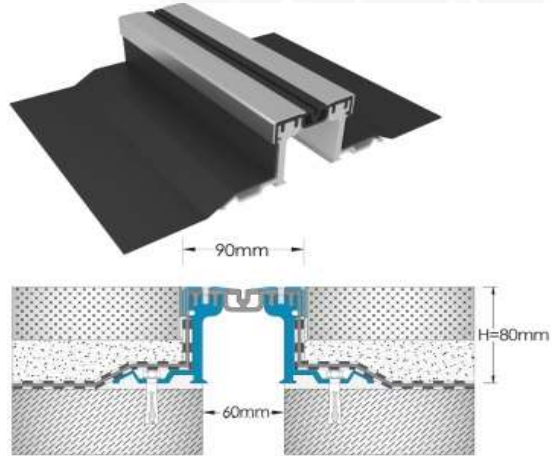

Teknik Özellikler / **Technical Features**

Dilatasyon Derz Açıklığı / Gap	60 mm
Yükseklik / Height	80 mm
Yüzey Genişliği / Surface Width	90 mm
Hareket Kapasitesi / Movement Capacity	± 20 mm
6 ton FORKLİFT, 15 ton KAMYON yüküne dayanıklıdır Resistan to the 6 tons FORKLIFT and 15 tons TRUCK load	

ZA 3290-060 H80

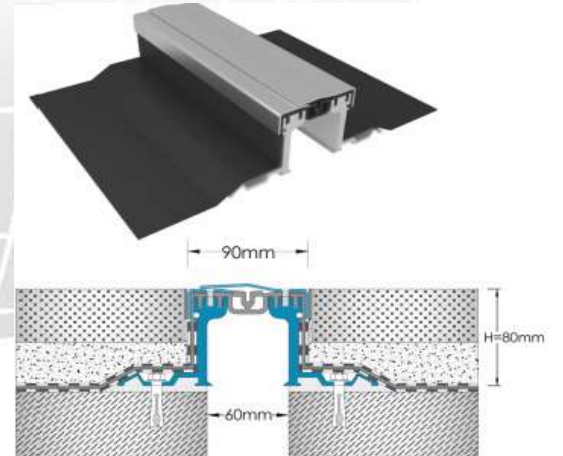

Teknik Özellikler / **Technical Features**

Dilatasyon Derz Açıklığı / Gap	60 mm
Yükseklik / Height	80 mm
Yüzey Genişliği / Surface Width	90 mm
Hareket Kapasitesi / Movement Capacity	± 20 mm
6 ton FORKLİFT, 15 ton KAMYON yüküne dayanıklıdır Resistan to the 6 tons FORKLIFT and 15 tons TRUCK load	



KAFES GROUP
Ostim Osb Mh. 1568 Cd. No:51
06374 Yenimahalle/Ankara/Turkey
Tel.:+90 (0) 535 248 97 85
WEB.: www.kafesgroup.com
EMAIL.: info@kafesgroup.com

KAFES GROUP PROFILE SYSTEMS

Kapak Dilatasyon Profilleri Cover Expansion Joint Profiles

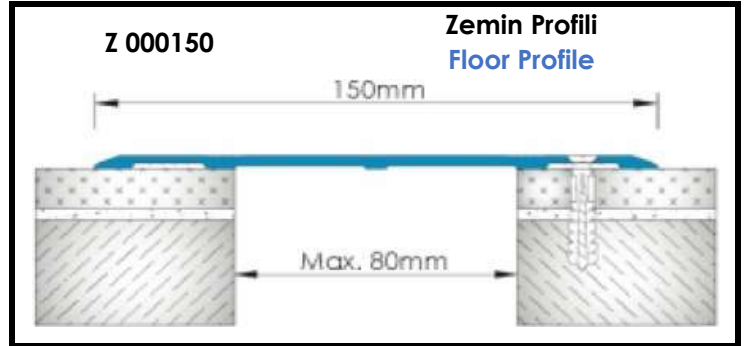
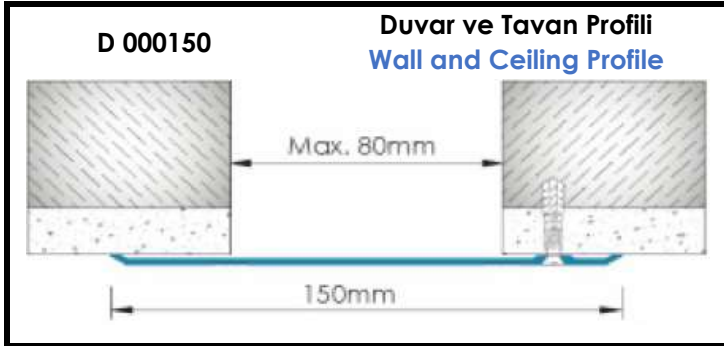
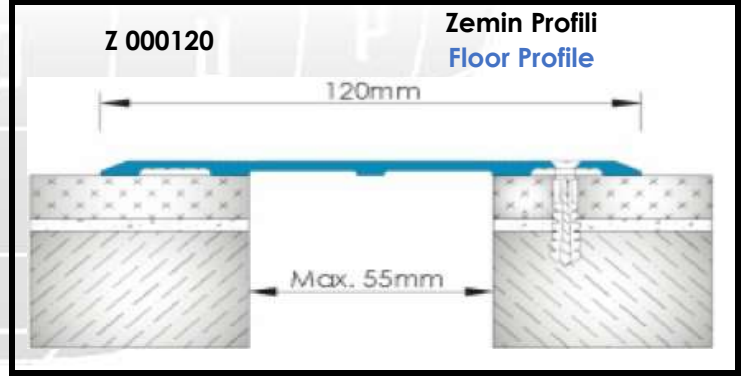
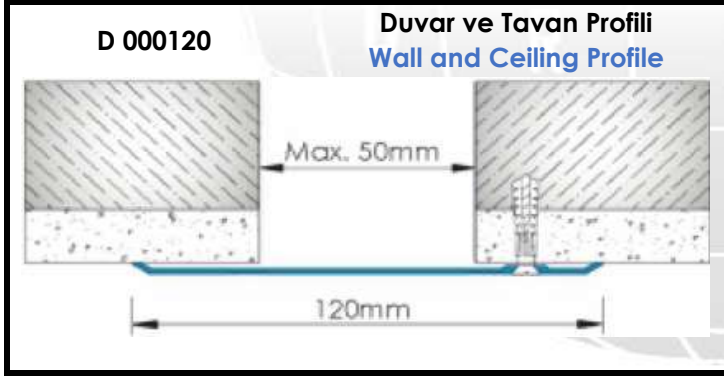
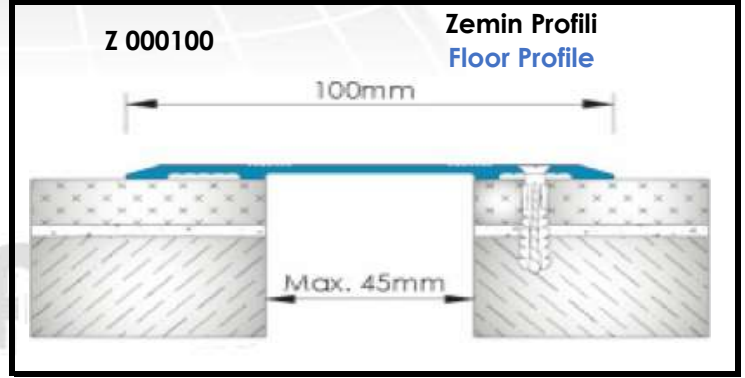
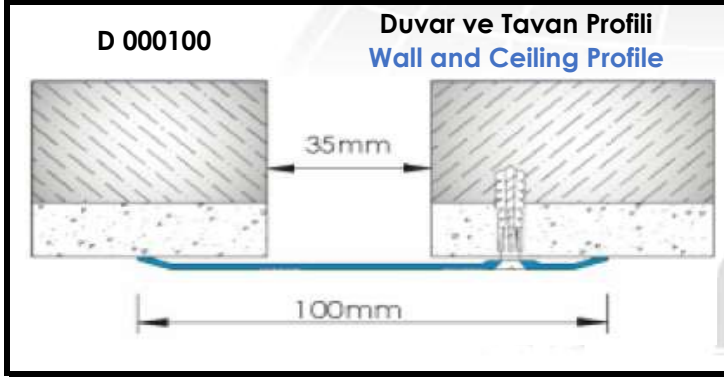



Kapak Dilatasyon Profilleri Cover Expansion Joint Profiles

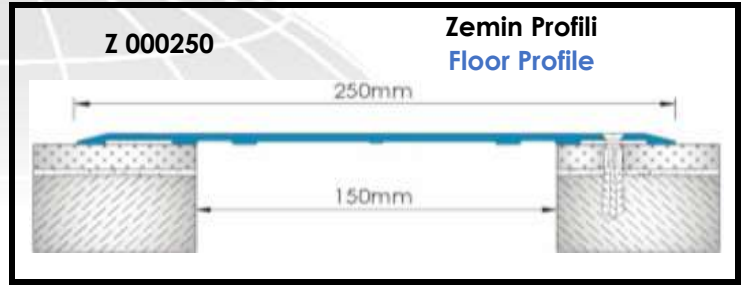
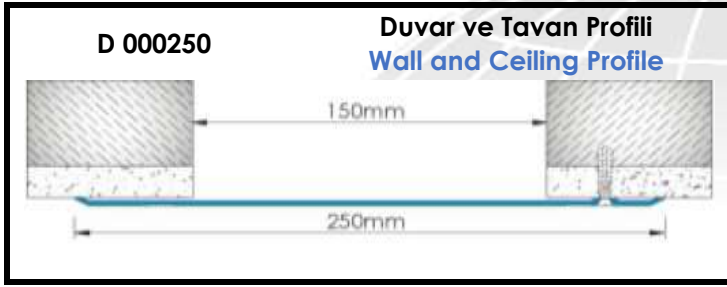
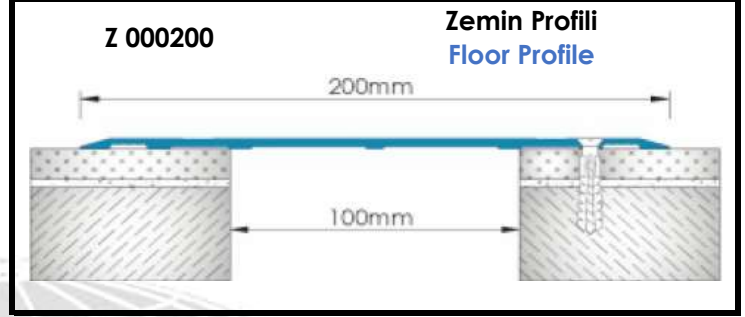
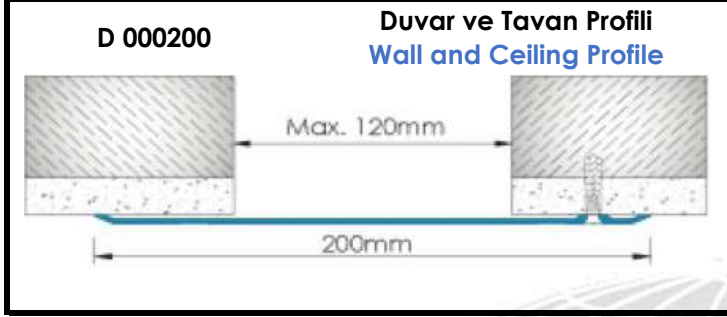

Gizli Vidalı Dilatasyon Kapak Profilleri / Hidden Screw Joint Cover Profiles

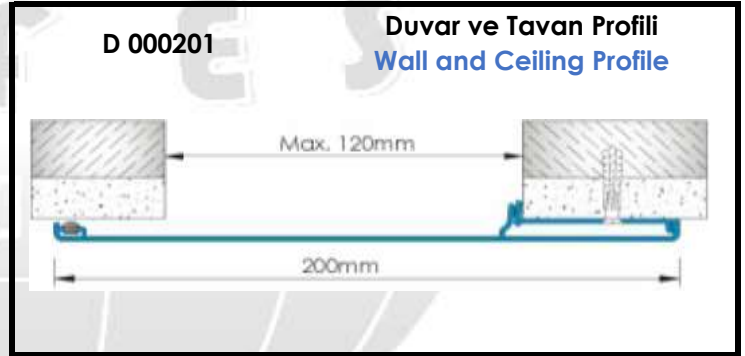
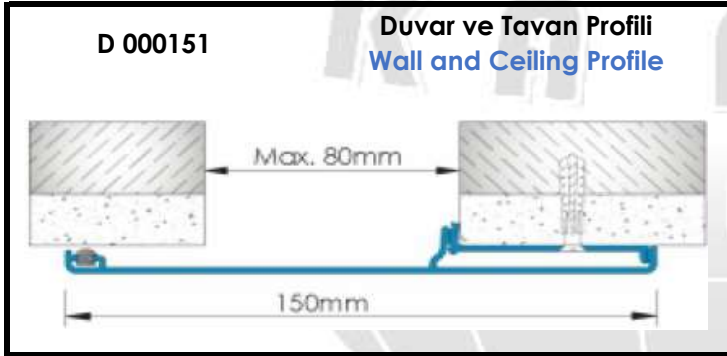

Ek Aparatı / Connection Item

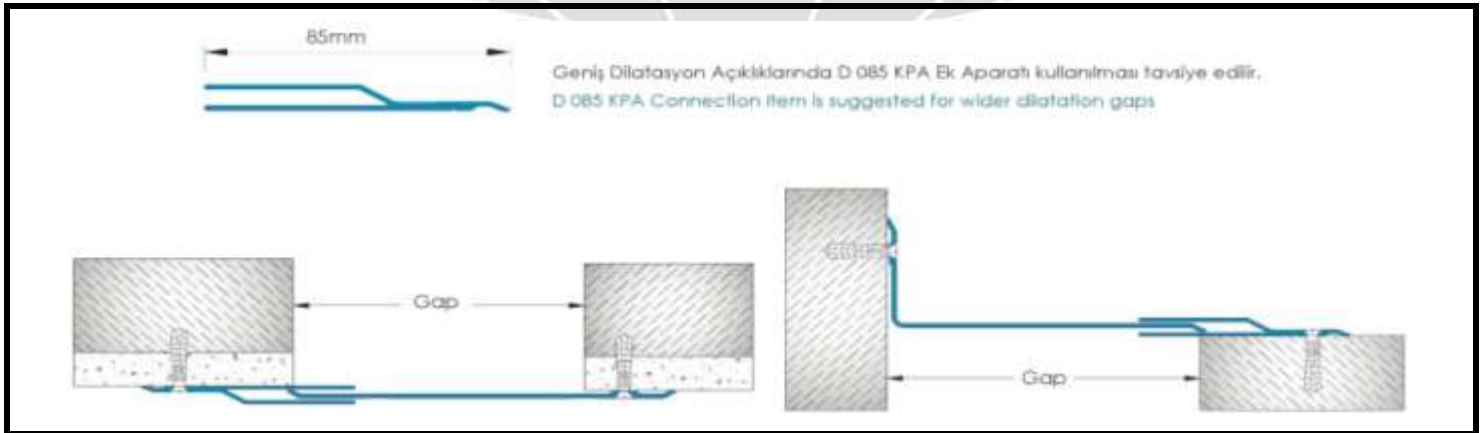



Kapak Dilatasyon Profilleri Cover Expansion Joint Profiles

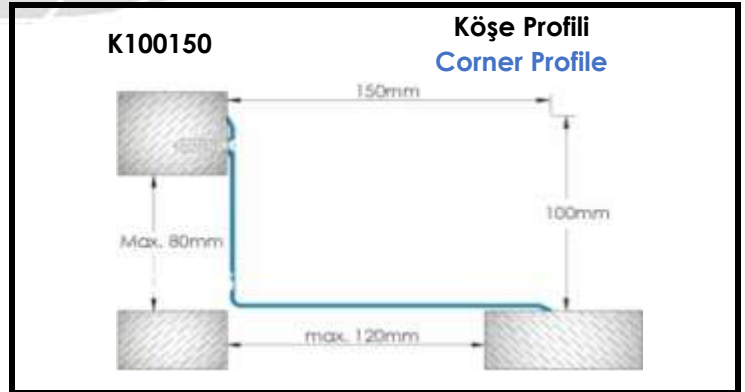
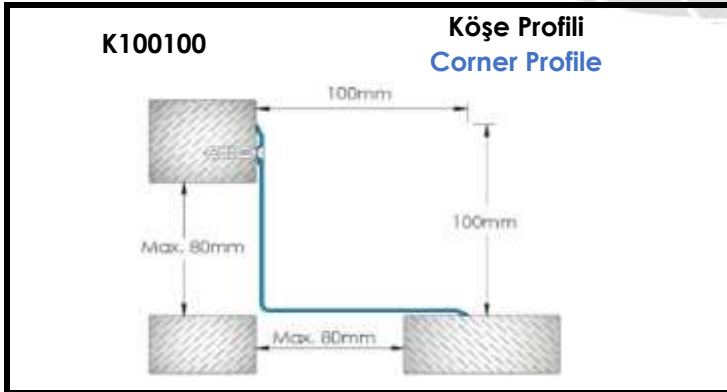
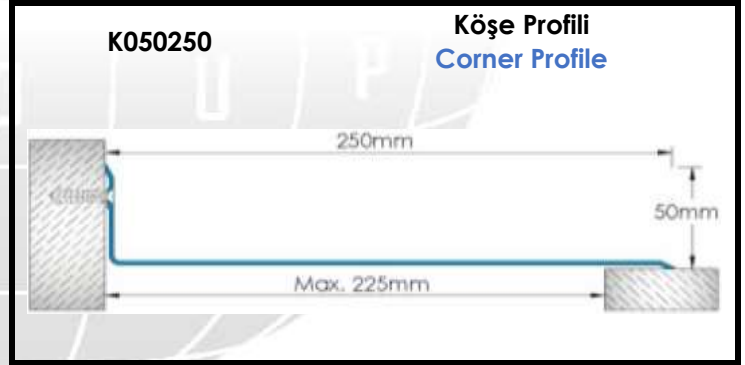
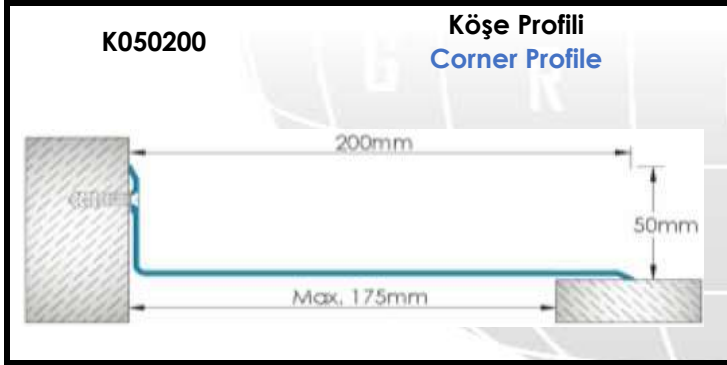
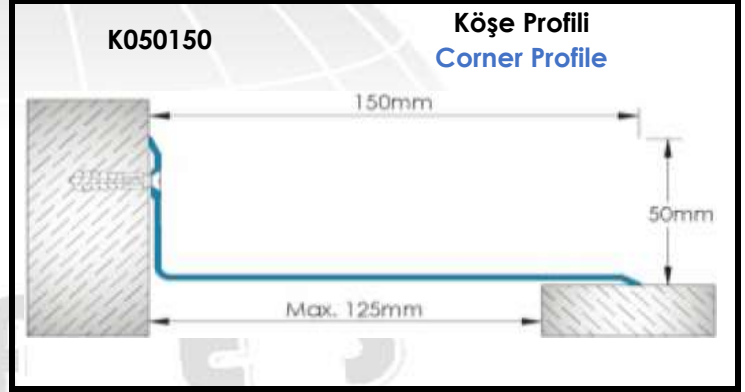
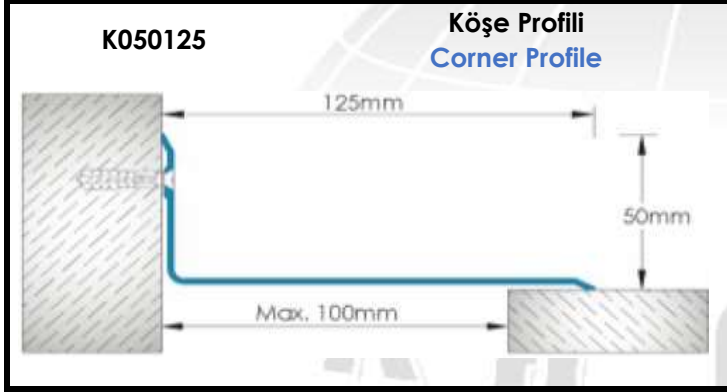
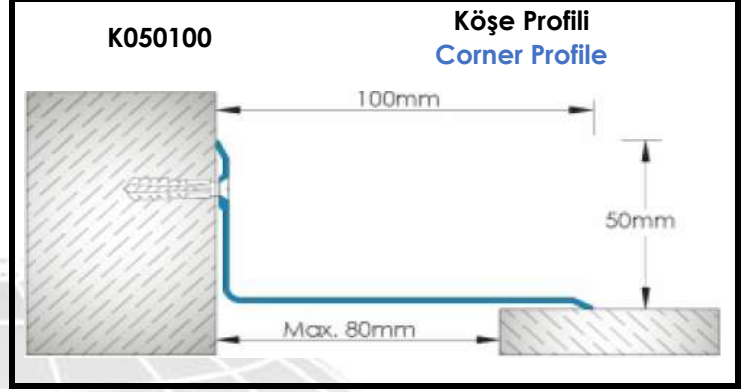
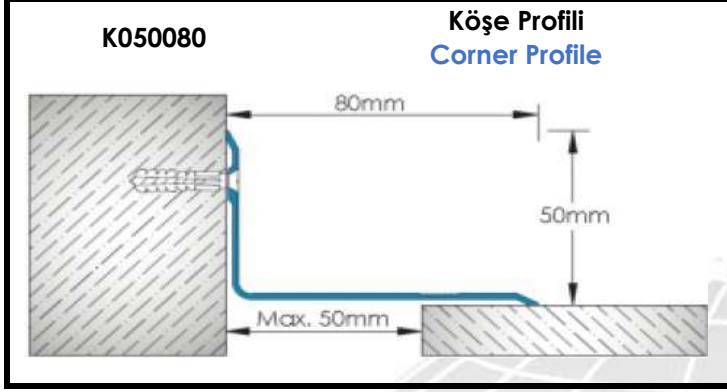



KAFES GROUP
Ostim Osb Mh. 1568 Cd. No:51
06374 Yenimahalle/Ankara/Turkey
Tel.:+90 (0) 535 248 97 85
WEB.: www.kafesgroup.com
EMAIL.: info@kafesgroup.com

KAFES GROUP PROFILE SYSTEMS

Duvar & Tavan Dilatasyon Derz Fitilleri / Wall & Ceiling Rubber Joint Profiles

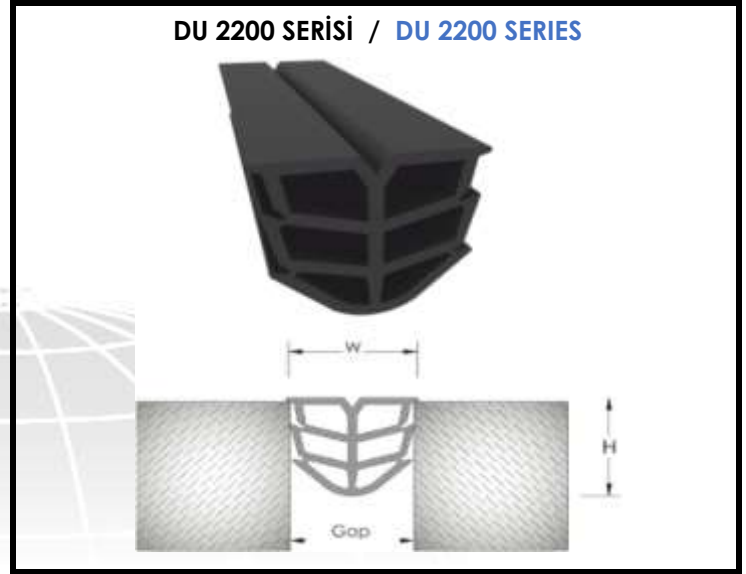
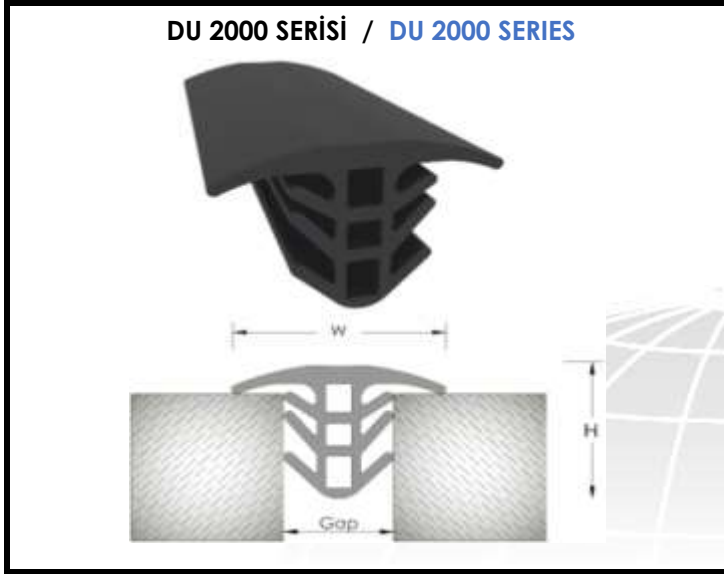

Profil Kodu Profile Code	Dilatasyon Açıklığı Gap	Yükseklik Height	Genişlik Widh	Hareket Kapasitesi Movement Ability	Renk Color
DU 2000-010	10 mm	45 mm	68 mm	+7 mm / -5 mm	Siyah / Black
DU 2000-030	30 mm	45 mm	68 mm	+7 mm / -5 mm	Siyah / Black
DU 2200-030	30 mm	28 mm	33 mm	+7 mm / -5 mm	Siyah / Black

Zemin Dilatasyon Derz Fitilleri / Floor Rubber Joint Profiles

Z 3600 SERİSİ / DU 2000 SERIES

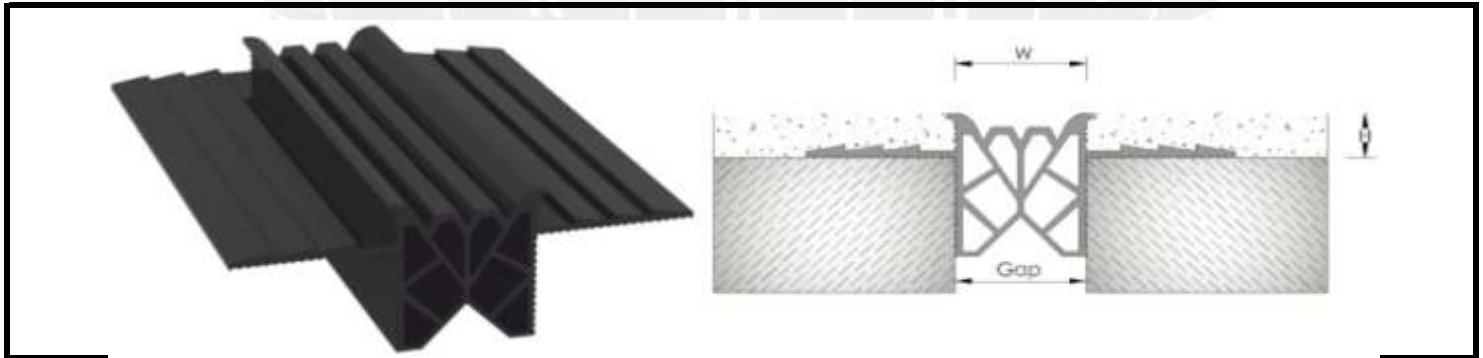

Profil Kodu Profile Code	Dilatasyon Açıklığı Gap	Yükseklik Height	Genişlik Widh	Hareket Kapasitesi Movement Ability	Yük Kapasitesi Load Capacity
ZA 3600-025	25 mm	19 mm	120 mm	+12 mm / -12 mm	
ZA 3600-050	50 mm	19 mm	154 mm	+25 mm / -25 mm	
ZA 3600-075	75 mm	19 mm	179 mm	+37 mm / -37 mm	
ZA 3600-100	100 mm	19 mm	204 mm	+50 mm / -50 mm	
ZA 3600-125	125 mm	19 mm	229 mm	+62 mm / -62 mm	
ZA 3600-150	150 mm	19 mm	254 mm	+75 mm / -75 mm	



KAFES GROUP
Ostim Osb Mh. 1568 Cd. No:51
06374 Yenimahalle/Ankara/Turkey
Tel.:+90 (0) 535 248 97 85
WEB.: www.kafesgroup.com
EMAIL.: info@kafesgroup.com

KAFES GROUP PROFILE SYSTEMS

Zemin Dilatasyon Derz Fitilleri / Floor Rubber Joint Profiles

ZU 4200 SERİSİ / ZU 4200 SERIES



ZU 4200 Serisi Epdm Fitillerimiz, Elastomerik yapısı sayesinde 65mm'ye kadar olan genişleme hareketlerini yanal ve dikey olarak karşılar. Özel tasarım yüksek kaliteli yapısı sayesinde yağlara, yakıtlara, UV ışınlarına, Radyasyona ve diğer kimyasallara uzun ömürlü olarak direnç sağlar. Epoksi bazlı yapıştırıcılar ile uygulanacağı zemine kolayca yapıştırılabilir.

By means of it's elastomeric structure, ZU 4200 Series EPDM Seal Rubber meet the expansion movements up to 65 mm laterally and vertically. Thanks to the high-quality special design rubber, it provides long lasting to oils, fuels, UV rays, radiation and other chemicals. Can easily be banded to the applied floor with epoxy based adhesive.

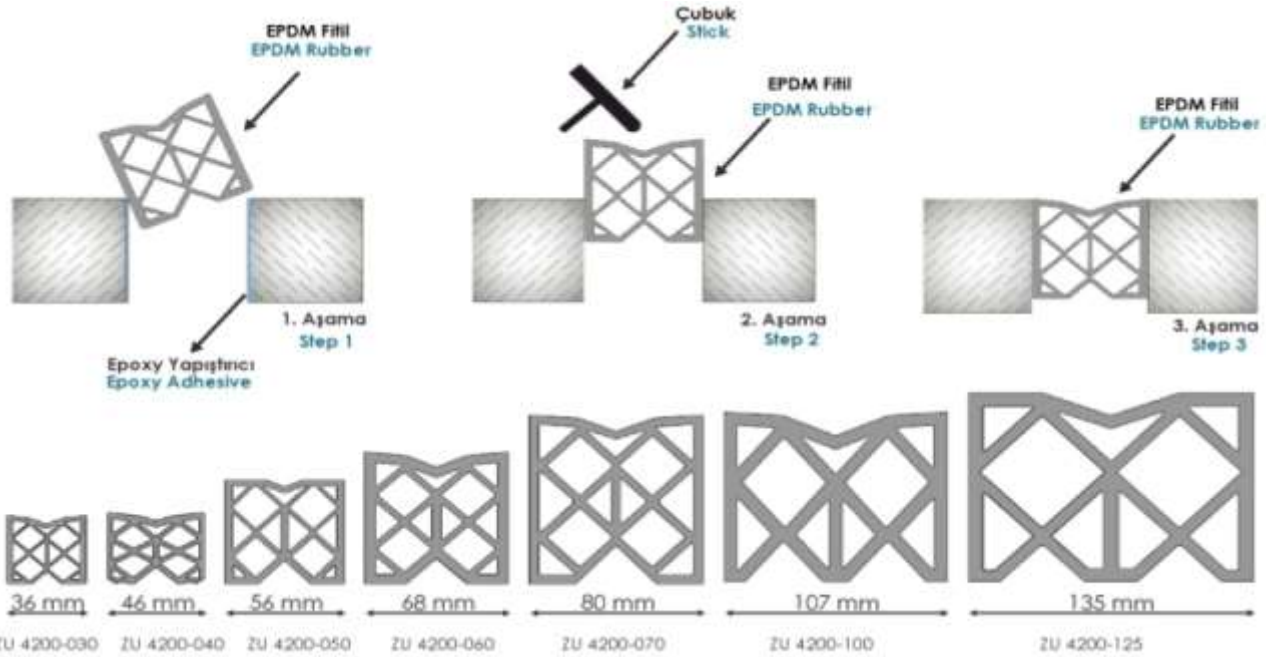

Profil Kodu Profile Code	Dilatasyon Açıklığı Gap	Yükseklik Height	Genişlik Widh	Hareket Kapasitesi Movement Ability	Yük Kapasitesi Load Capacity
ZU 4200-030 H35	min 18mm / max 30mm	35 mm	36 mm	12 mm	
ZU 4200-040 H37	min 20mm / max 40mm	37 mm	46 mm	20 mm	
ZU 4200-050 H55	min 25mm / max 50mm	55 mm	56 mm	25 mm	
ZU 4200-060 H70	min 30mm / max 60mm	70 mm	68 mm	30 mm	
ZU 4200-070 H87	min 35mm / max 70mm	87 mm	80 mm	35 mm	
ZU 4200-0100 H90	min 50mm / max 100mm	90 mm	107 mm	50 mm	
ZU 4200-0125 H100	min 55mm / max 125mm	100 mm	135 mm	70 mm	



KAFES GROUP
Ostim Osb Mh. 1568 Cd. No:51
06374 Yenimahalle/Ankara/Turkey
Tel.:+90 (0) 535 248 97 85
WEB.: www.kafesgroup.com
EMAIL.: info@kafesgroup.com

KAFES GROUP PROFILE SYSTEMS

Çelik Dilatasyon Proflleri / Steel Expansion Joint Profiles

ZA 5000 SERİSİ / ZA 5000 SERIES

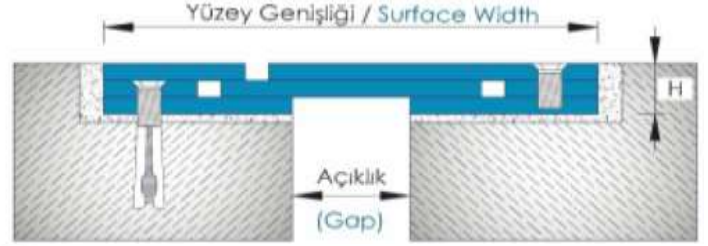

Profil Kodu Profile Code	Dilatasyon Açıklığı Gap	Yükseklik Height	Yüzey Geniřliđi Surface Width	Hareket Kapasitesi Movement Ability	Yük Kapasitesi Load Capacity
ZA 5000-030	30 mm	21-24 mm	160 mm	± 10 mm	
ZA 5000-050	50 mm	24-26-28 mm	210 mm	± 10 mm	
ZA 5000-080	80 mm	24-26-28 mm	240 mm	± 10 mm	
ZA 5000-100	100 mm	28 mm	300 mm	± 10 mm	
ZA 5000-120	120 mm	28-33 mm	320 mm	± 10 mm	
ZA 5000-150	150 mm	28-30-33 mm	330 mm	± 10 mm	
ZA 5000-200	200 mm	30-33-35-40 mm	440 mm	± 15 mm	
ZA 5000-250	250 mm	30-35-40 mm	40 mm	± 15 mm	
ZA 5000-300	300 mm	30-35-40-43 mm	540 mm	± 20 mm	
ZA 5000-500	500 mm	30-35-40-53 mm	800 mm	± 25 mm	

Ađır yük geiři iin dizayn edilmiř Çelik Profillerle yapılmıř Sinüz Plakalı özel bir tasarımıdır. Sinüz řeklindeki derz boşlukları sayesinde tekerlek ile derz arasında boşluk kalmadıđından tekerleđin süreli yüzeye temasına imkan verir. Dikey aralıklı aksine Sinüz Plakalı genleřme derzlerinin üzerinden geen araç cinsi ile ilgili herhangi bir kısıtlama yoktur. Reach Truck, Forklift ve Trabspalet araçlarının Sinüz Plakaların üzerinden sorunsuz bir řekilde geerek dilatasyon derzlerinin bozulmasına olanak sađlamayacaktır.

Its is a steel profiles sinuz plated with special design for heavy load transition. with the help of sinus shoped joint gaps, it blocks the gap between wheels and joints and helps the wheels meeting with surface clearly. with these sinus plated expansion joint profiles there is no restriction about the type of vehicle. and also these profiles let the truck forklifts and transpattes an easy transition without any and dilatation joints.

Alüminyum Otopark Proflleri / Aluminium Carpark Profiles

Z 000 SERİSİ / Z 000 SERIES



Profil Kodu Profile Code	Dilatasyon Açıklığı Gap	Kalınlık Thickness	Yüzey Geniřliđi Surface Width	Yük Kapasitesi Load Capacity
Z 000101	35 mm	4 mm	100 mm	
Z 000151	80 mm	5 mm	150 mm	
Z 000201	100 mm	5 mm	200 mm	

KAFES GROUP INDUSTRY LTD.CO.

Ostim Osb Mh. 1568 Cd. No:51 06105 Yenimahalle/ANKARA

Ostim V.D. 4871013616

Tic.Sic.No. 447343



KAFES GROUP
Ostim Osb Mh. 1568 Cd. No:51
06374 Yenimahalle/Ankara/Turkey
Tel.:+90 (0) 535 248 97 85
WEB.: www.kafesgroup.com
EMAIL.: info@kafesgroup.com

KAFES GROUP PROFILE SYSTEMS

Kauçuk Otopark Zemin Proflleri / Rubber Carpark Floor Profiles

ZK SERİSİ / ZK SERIES



Profil Kodu Profile Code	Dilatasyon Açıklığı Gap	Yükseklik Height	Yüzey Geniřliđi Surface Widh	Yük Kapasitesi Load Capacity
ZK 200	50 mm	10 mm	200 mm	35 kN / 160 kN
ZK 250	100 mm	12 mm	250 mm	25 kN / 90 kN
ZK 300	150 mm	14 mm	300 mm	
ZK 350	200 mm	16 mm	350 mm	
ZK 400	250 mm	18 mm	400 mm	

ZK Kauçuk Otopark Profili, otopark, depo, fabrika gibi endüstriyel zeminlerde yoğun araç trafiđine maruz kalan yerler için özel olarak tasarlanmıřtır. İçerisindeki ST37 çelik lama profili kalınlığı ve geniřliđi, dilatasyon boşluđuna göre farklı ölçülerde üretilir ve vulkanizasyon işlemi ile preslenmiř EPDM kauçuk içerisine gömülür. Kauçuk yapısı sayesinde geçişlerde sesi azaltır ve çelik profilin zarar görmesini engeller

ZK Rubber Carpark Profiles is speciacly designed for industrial floors that is exposed to heavy load traffic. the thickness and width of the inner ST37 steel profiles are produced different sizes according to the expansion joint gap, and embedded into the pressed EPDM rubber by vulcanization process. Thanks it's rubber structure, it reduces the noise prebents the steel profile.





KAFES GROUP
Ostim Osb Mh. 1568 Cd. No:51
06374 Yenimahalle/Ankara/Turkey
Tel.:+90 (0) 535 248 97 85
WEB.: www.kafesgroup.com
EMAIL.: info@kafesgroup.com

KAFES GROUP PROFILE SYSTEMS

Kasisli Otopark Dilatasyon Profilleri / Carpark Profiles

ZU 4000 SERİSİ / ZU 4000 SERIES

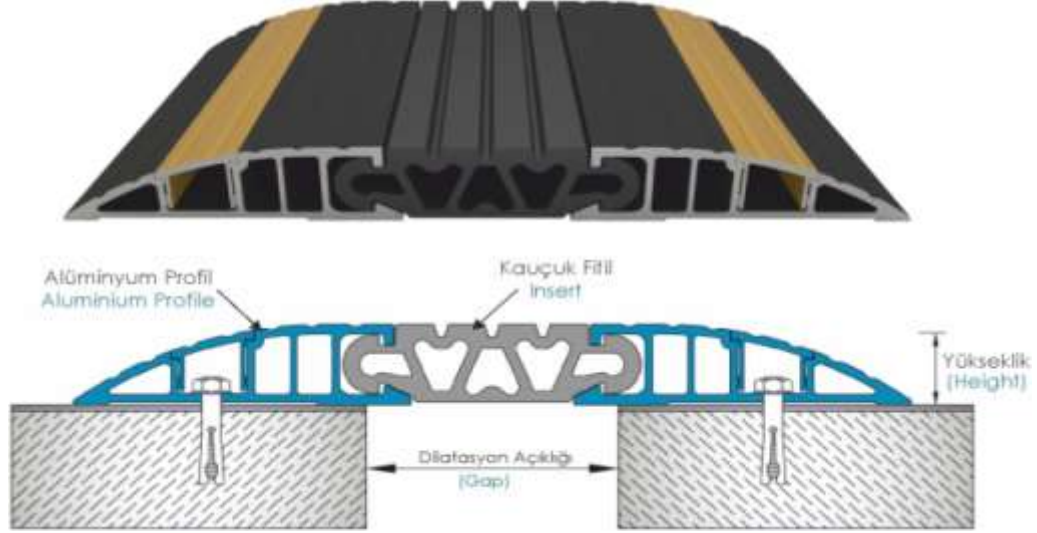

Profil Kodu Profile Code	Dilatasyon Açıklığı Gap	Yükseklik Height	Yüzey Genişliği Surface Width	Hareket Kapasitesi Movement Ability	Yük Kapasitesi Load Capacity
ZU 4000-050	50 mm	35 mm	300 mm	± 10 mm	
ZU 4000-100	100 mm	35 mm	327 mm	± 10 mm	
ZU 4000-150	150 mm	40 mm	365 mm	± 25 mm	

ZU 4005 SERİSİ / ZU 4005 SERIES

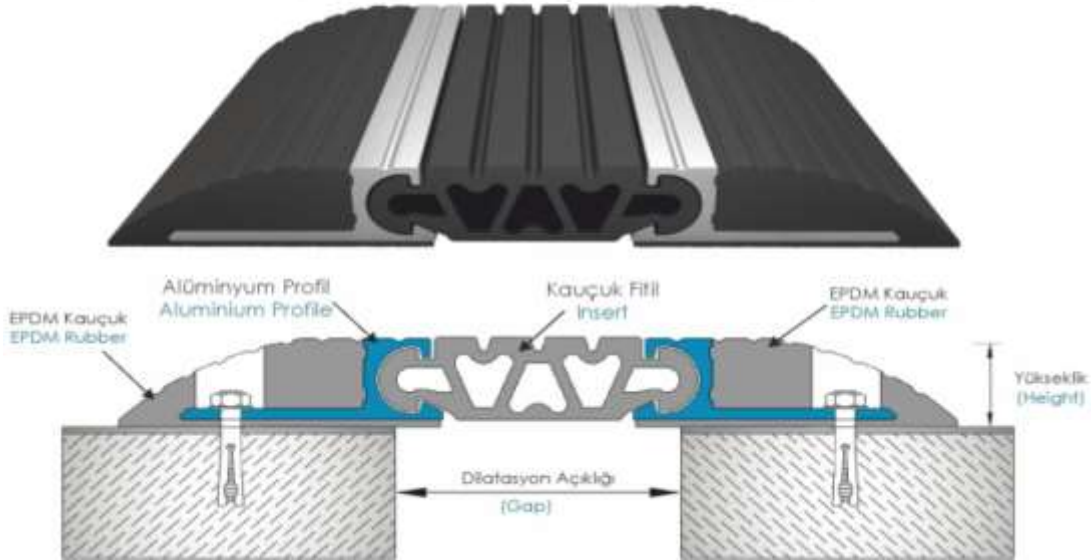

Profil Kodu Profile Code	Dilatasyon Açıklığı Gap	Yükseklik Height	Yüzey Genişliği Surface Width	Hareket Kapasitesi Movement Ability	Yük Kapasitesi Load Capacity
ZU 4005-050	50 mm	35 mm	280 mm	± 10 mm	
ZU 4005-100	100 mm	40 mm	300 mm	± 10 mm	
ZU 4005-150	150 mm	40 mm	340 mm	± 25 mm	



KAFES GROUP
Ostim Osb Mh. 1568 Cd. No:51
06374 Yenimahalle/Ankara/Turkey
Tel.:+90 (0) 535 248 97 85
WEB.: www.kafesgroup.com
EMAIL.: info@kafesgroup.com

KAFES GROUP PROFILE SYSTEMS

Dilatasyon Yalıtım Bantları / Rubber Insulating Tapes

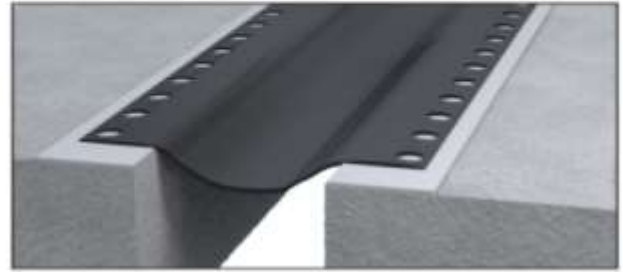
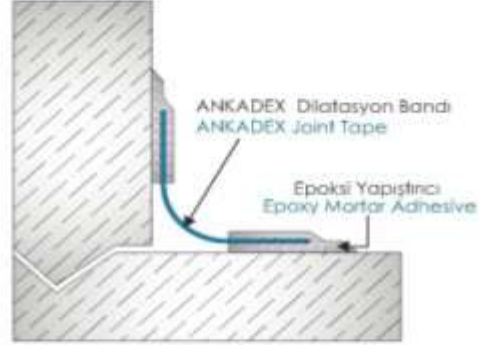
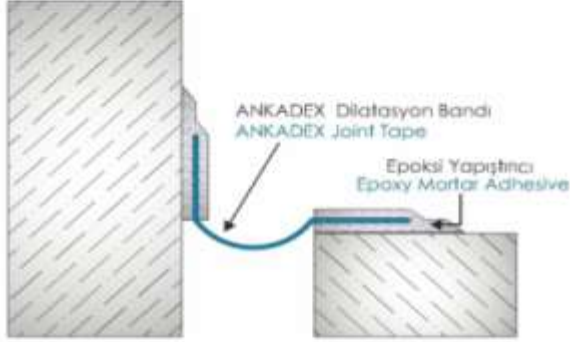
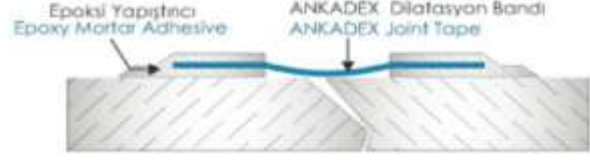

Dilatasyon Yalıtım Bantları, yüksek esneklik sayesinde tm düşey ve yatay dilatasyon boşluklarının yalıtımında, radye-perde ve perde-perde soğuk derzlerin su yalıtım uygulamalarında kullanılmaktadır. 10 cm den 150 cm'e kadar farklı genişliklerde üretilmektedir. Delikli kenarları sayesinde Epoksi Mantar türündeki yapıştırıcılar ile kolaylıkla uygulanabilir. ek yerleri için özel yapıştırıcı kullanılmaktadır.

EPDM Insulation Tapes are used safety for the insulcation of all vertical and horizontal dilatation spacing, for water insulcation of Radial-Curtain and Curtain-Curtain cold joints because of having high elasticity. they can be produced in different disths from 10 cm to 150 cm with the help of preforated sides they be aeasily appli,ed with Epoxy Marter adhesive. for Joint parts a special adhesive must be used.

Pah Bandı / TPE based

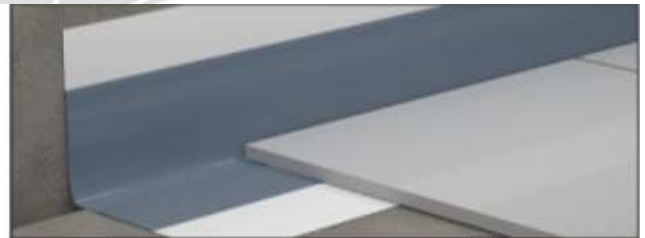

Pah bantları, duvar ve zemin birleşimleri ile yapısal derzlerin yalıtımında kullanılan tpe esaslı bantlardır. file taşıyıcılı ve keçe taşıyıcılı olarak üretilir. ozon, ov ve birçok kimyasala karşı dayanıklıdır.

Water Barriers are TPE based insulation tapes used for the insulation of structural joints and wall & ceiling combinations. they are produced as Meshed and Felled.



KAFES GROUP
Ostim Osb Mh. 1568 Cd. No:51
06374 Yenimahalle/Ankara/Turkey
Tel.:+90 (0) 535 248 97 85
WEB.: www.kafesgroup.com
EMAIL.: info@kafesgroup.com

KAFES GROUP PROFILE SYSTEMS

Dilatasyonlu Harpuřta Profilleri / Cooping Expansion Joint Profiles

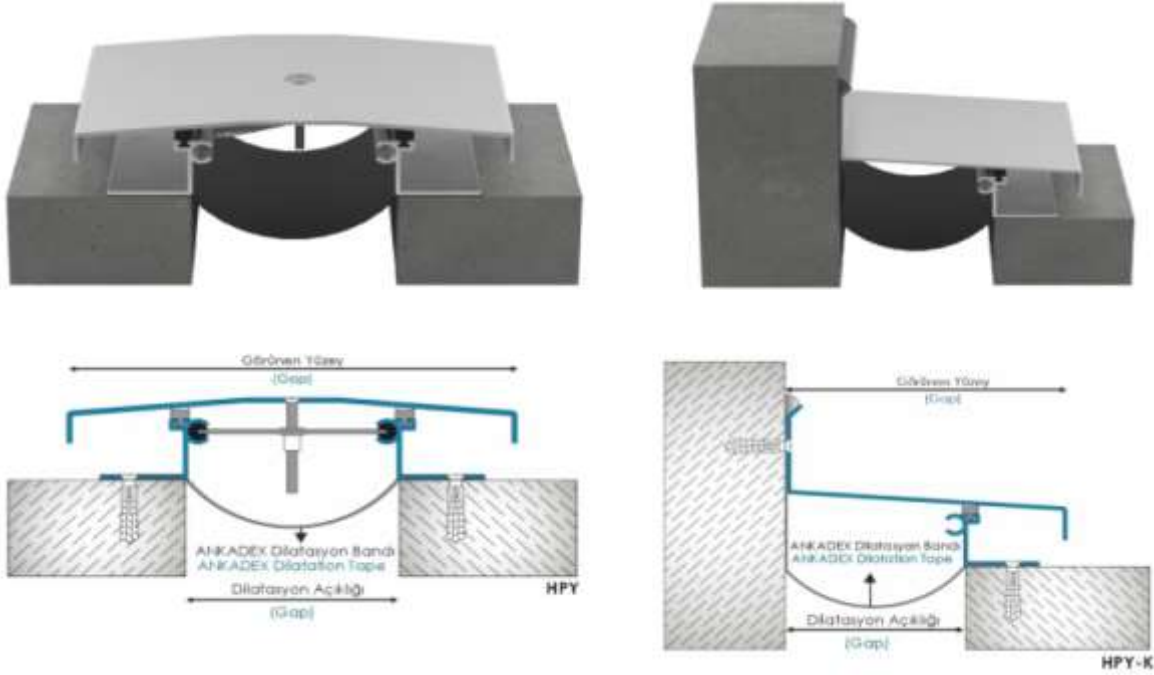

Dilatasyonlu harpuřta profillerini farklı genişliklerdeki dilatasyon açıklıklarına göre ve farklı kalınlıklarda ki parapet duvarlarına göre özel olarak imal edilir. İstenirse dilatasyon yalıtım bantları ile tam bir sızdırmazlık elde edilir. Ek yerleri için özel "H" profillerimiz ve köşe Trapez çitaller için detaylarımız bulunmaktadır.

Expansion Joint Coping Profiles are produced for different joint gaps and different wall thicknesses privately. The profiles can be used with insulation Tapes to get certain tightness. We have special "H" profiles for the joints and special details for corners.

Parapet OProfilleri / Parapet Profiles

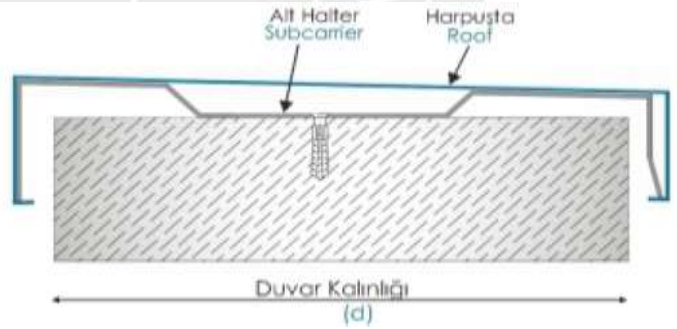
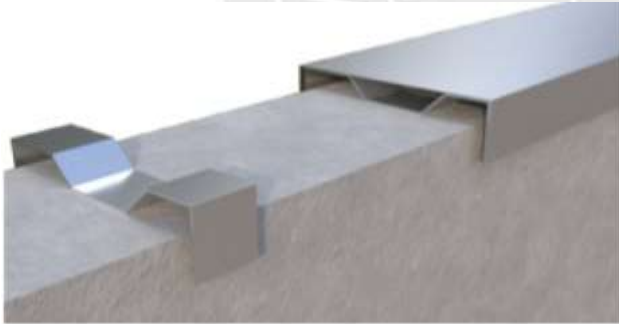

parapet profilleri farklı kalınlıklarda ki Duvarlar için özel olarak imal edilmektedir her kalınlıktaki Duvarlar için çözümlerimiz mevcuttur parapet profillerini alt ve üst parçadan oluşan çift parçalı sistemdir özel alařımlı kalbinize çelikten üretilmiş 15 santimetre genişlikte 50 santimetre ara ile kullanılan of Alper parapete sabitledikten sonra alüminyum harpuřta lar Alper'le klip řeklinde geçirilerek monte edilir

Parapet are produced for different wall thicknesses privately, we have solutions for any kind of wall thicknesses. our profiles are made of 2 parts as top bottom. aluminium Coping Profiles are installed on the dumbbells in the form of a clip after 15 cm width lower dumbbells that are produced by special alloyed galvanise and are 50 cm intervals fixed to the parapet profile.



KAFES GROUP
Ostim Osb Mh. 1568 Cd. No:51
06374 Yenimahalle/Ankara/Turkey
Tel.:+90 (0) 535 248 97 85
WEB.: www.kafesgroup.com
EMAIL.: info@kafesgroup.com

KAFES GROUP PROFILE SYSTEMS

Seramik Bitim ve Dış Köşe Profilleri / Ceramic Ending & Exterior Tile Profiles

SK SERIES

Renk Seçenekleri / Color Options

SK1 Gümüşü / SK1 Silver
SK1 Altın / SK1 Gold
SK1 Bronz / SK1 Bronze
SK1 Gümüşü / SK1 Silver
SK1 Altın / SK1 Gold
SK1 Bronz / SK1 Bronze

Seramik Dış Köşe Profili / Exterior Tile Trim Profile

Yükseklik / Height	8mm - 10mm - 12mm - 14mm
Uzunluk / Length	2,50 m / 2,70 m
Materyal / Material	Eloksallı Alüminyum Anodised Aluminium

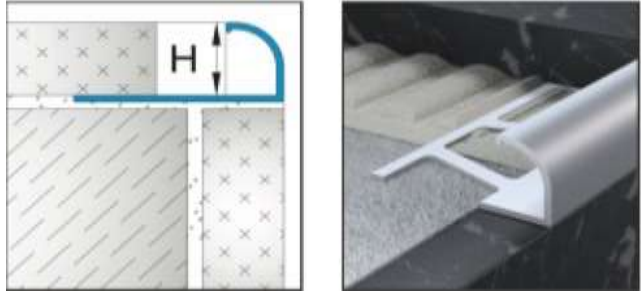

SC SERIES

Renk Seçenekleri / Color Options

SK1 Gümüşü / SK1 Silver
SK1 Altın / SK1 Gold
SK1 Bronz / SK1 Bronze
SK1 Gümüşü / SK1 Silver
SK1 Altın / SK1 Gold
SK1 Bronz / SK1 Bronze

Seramik Dış Köşe Profili / Exterior Tile Trim Profile

Yükseklik / Height	10mm - 12mm
Uzunluk / Length	2,50 m / 2,70 m
Materyal / Material	Eloksallı Alüminyum Anodised Aluminium

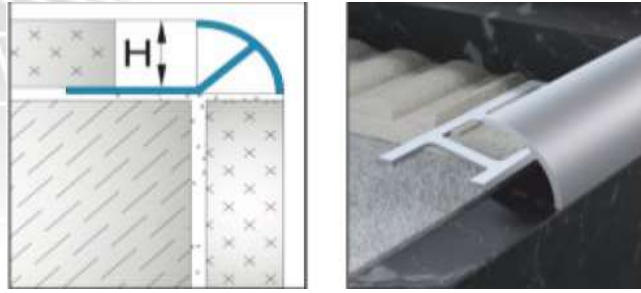

SKK SERIES

Renk Seçenekleri / Color Options

SK1 Gümüşü / SK1 Silver
SK1 Altın / SK1 Gold
SK1 Bronz / SK1 Bronze
SK1 Gümüşü / SK1 Silver
SK1 Altın / SK1 Gold
SK1 Bronz / SK1 Bronze

Seramik Dış Köşe Profili / Exterior Tile Trim Profile

Yükseklik / Height	10mm - 12mm
Uzunluk / Length	2,50 m / 2,70 m
Materyal / Material	Eloksallı Alüminyum Anodised Aluminium

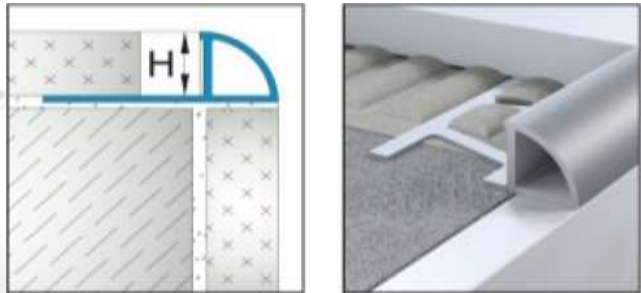

SE SERIES

Renk Seçenekleri / Color Options

SK1 Gümüşü / SK1 Silver
SK1 Altın / SK1 Gold
SK1 Bronz / SK1 Bronze
SK1 Gümüşü / SK1 Silver
SK1 Altın / SK1 Gold
SK1 Bronz / SK1 Bronze

Seramik Dış Köşe Profili / Exterior Tile Trim Profile

Yükseklik / Height	10mm - 12mm
Uzunluk / Length	2,50 m / 2,70 m
Materyal / Material	Eloksallı Alüminyum Anodised Aluminium

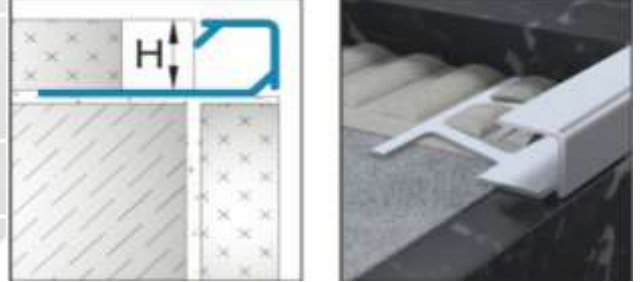

SG SERIES

Renk Seçenekleri / Color Options

SK1 Gümüşü / SK1 Silver
SK1 Altın / SK1 Gold
SK1 Bronz / SK1 Bronze
SK1 Gümüşü / SK1 Silver
SK1 Altın / SK1 Gold
SK1 Bronz / SK1 Bronze

Seramik Dış Köşe Profili / Exterior Tile Trim Profile

Yükseklik / Height	6mm - 8mm - 10mm - 12mm
Uzunluk / Length	2,50 m / 2,70 m
Materyal / Material	Eloksallı Alüminyum Anodised Aluminium

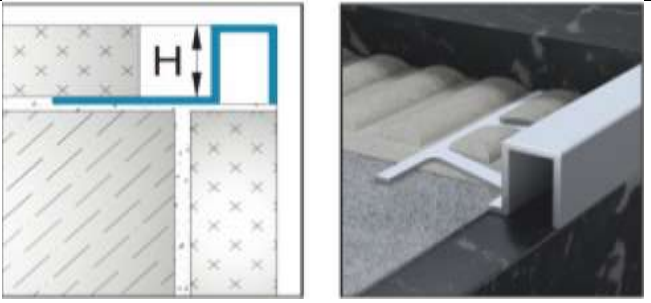



KAFES GROUP
Ostim Osb Mh. 1568 Cd. No:51
06374 Yenimahalle/Ankara/Turkey
Tel.:+90 (0) 535 248 97 85
WEB.: www.kafesgroup.com
EMAIL.: info@kafesgroup.com

KAFES GROUP PROFILE SYSTEMS

Seramik Bitim ve Dış Köşe Profilleri / Ceramic Ending & Exterior Tile Profiles

SD SERIES

Farklı Seçenekler / Color Options

Mat. Çiğnelli / Matt Silver, Mat. Altın / Matt Gold, Mat. Bronz / Matt Bronze, Farklı Lümlü / Angled Silver, Farklı Altın / Angled Gold, Farklı Bronz / Angled Bronze

Seramik Dış Köşe Profili / Exterior Tile Trim Profile

Yükseklik / Height	6mm - 8mm - 10mm - 12mm - 14mm - 22mm
Uzunluk / Length	2,50 m / 2,70 m
Materyal / Material	Eloksallı Alüminyum Anodised Aluminium



SD PVC SERIES

Farklı Seçenekler / Color Options

Mat. Çiğnelli / Matt Silver, Mat. Altın / Matt Gold, Mat. Bronz / Matt Bronze, Farklı Lümlü / Angled Silver, Farklı Altın / Angled Gold, Farklı Bronz / Angled Bronze

Seramik Dış Köşe Profili / Exterior Tile Trim Profile

Yükseklik / Height	10mm - 12mm
Uzunluk / Length	2,50 m / 2,70 m
Materyal / Material	PVC PVC



ST SERIES

Farklı Seçenekler / Color Options

Mat. Çiğnelli / Matt Silver, Mat. Altın / Matt Gold, Mat. Bronz / Matt Bronze, Farklı Lümlü / Angled Silver, Farklı Altın / Angled Gold, Farklı Bronz / Angled Bronze

Seramik Dış Köşe Profili / Exterior Tile Trim Profile

Yükseklik / Height	10mm - 12mm
Uzunluk / Length	2,50 m / 2,70 m
Materyal / Material	Eloksallı Alüminyum Anodised Aluminium

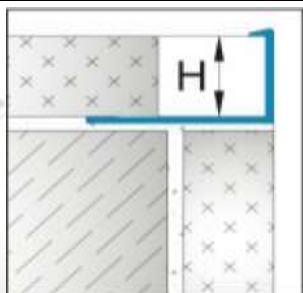

SX SERIES

Farklı Seçenekler / Color Options

Mat. Çiğnelli / Matt Silver, Mat. Altın / Matt Gold, Mat. Bronz / Matt Bronze, Farklı Lümlü / Angled Silver, Farklı Altın / Angled Gold, Farklı Bronz / Angled Bronze

Seramik Dış Köşe Profili / Exterior Tile Trim Profile

Yükseklik / Height	10mm - 12mm
Uzunluk / Length	2,50 m / 2,70 m
Materyal / Material	Eloksallı Alüminyum Anodised Aluminium

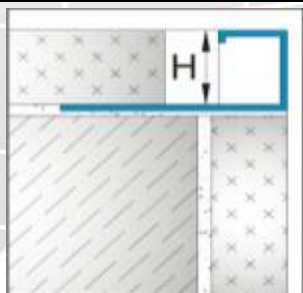

SF SERIES

Farklı Seçenekler / Color Options

Mat. Çiğnelli / Matt Silver, Mat. Altın / Matt Gold, Mat. Bronz / Matt Bronze, Farklı Lümlü / Angled Silver, Farklı Altın / Angled Gold, Farklı Bronz / Angled Bronze

Seramik Dış Köşe Profili / Exterior Tile Trim Profile

Yükseklik / Height	10mm - 12mm - 14mm
Uzunluk / Length	2,50 m / 2,70 m
Materyal / Material	Eloksallı Alüminyum Anodised Aluminium

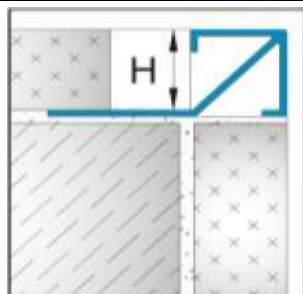



KAFES GROUP
Ostim Osb Mh. 1568 Cd. No:51
06374 Yenimahalle/Ankara/Turkey
Tel.:+90 (0) 535 248 97 85
WEB.: www.kafesgroup.com
EMAIL.: info@kafesgroup.com

KAFES GROUP PROFILE SYSTEMS

Seramik İç Köşe Profilleri / Ceramic Interior Tile Profiles

SI SERIES

Farklı Seçenekler / Color Options

Mat. Çinko / Mat. Zinc
Mat. Altın / Mat. Gold
Mat. Bronz / Mat. Bronze
Farklı Lümen / Light Colors
Farklı Altın / Light Gold
Farklı Bronz / Light Bronze

Seramik İç Köşe Profili / Interior Tile Trim Profile

Yükseklik / Height	6mm - 8mm - 10mm - 12mm - 14mm
Uzunluk / Length	2,50 m / 2,70 m
Materyal / Material	Eloksallı Alüminyum Anodised Aluminium

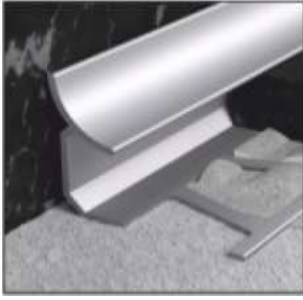
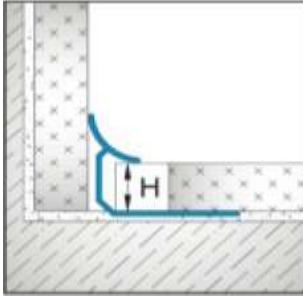

IK SERIES

Farklı Seçenekler / Color Options

Mat. Çinko / Mat. Zinc
Mat. Altın / Mat. Gold
Mat. Bronz / Mat. Bronze
Farklı Lümen / Light Colors
Farklı Altın / Light Gold
Farklı Bronz / Light Bronze

Seramik İç Köşe Profili / Interior Tile Trim Profile

Yükseklik / Height	15mm - 20mm
Uzunluk / Length	2,50 m / 2,70 m
Materyal / Material	Eloksallı Alüminyum Anodised Aluminium

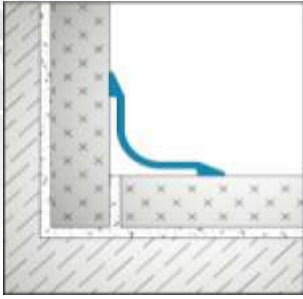



SD SS SERIES

Farklı Seçenekler / Color Options

Mat. Çinko / Mat. Zinc
Mat. Altın / Mat. Gold
Mat. Bronz / Mat. Bronze
Farklı Lümen / Light Colors
Farklı Altın / Light Gold
Farklı Bronz / Light Bronze

Seramik Dış Köşe Profili / Exterior Tile Trim Profile

Yükseklik / Height	8mm - 10mm - 12mm
Uzunluk / Length	2,50 m
Materyal / Material	Paslanmaz Çelik Stainless Steel



SK SS SERIES

Farklı Seçenekler / Color Options

Mat. Çinko / Mat. Zinc
Mat. Altın / Mat. Gold
Mat. Bronz / Mat. Bronze
Farklı Lümen / Light Colors
Farklı Altın / Light Gold
Farklı Bronz / Light Bronze

Seramik Dış Köşe Profili / Exterior Tile Trim Profile

Yükseklik / Height	8mm - 10mm - 12mm
Uzunluk / Length	2,50 m
Materyal / Material	Paslanmaz Çelik Stainless Steel



SC SS SERIES

Farklı Seçenekler / Color Options

Mat. Çinko / Mat. Zinc
Mat. Altın / Mat. Gold
Mat. Bronz / Mat. Bronze
Farklı Lümen / Light Colors
Farklı Altın / Light Gold
Farklı Bronz / Light Bronze

Seramik Dış Köşe Profili / Exterior Tile Trim Profile

Yükseklik / Height	6mm - 8mm - 10mm - 12mm - 14mm
Uzunluk / Length	2,50 m
Materyal / Material	Paslanmaz Çelik Stainless Steel

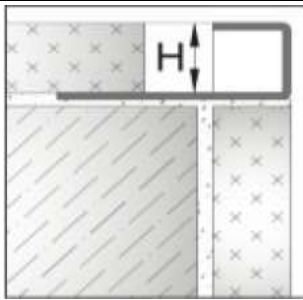



KAFES GROUP
Ostim Osb Mh. 1568 Cd. No:51
06374 Yenimahalle/Ankara/Turkey
Tel.:+90 (0) 535 248 97 85
WEB.: www.kafesgroup.com
EMAIL.: info@kafesgroup.com

KAFES GROUP PROFILE SYSTEMS

Seramik Bitim ve İç Köşe Profilleri / Edge Profiles For Ceramic

SX SS SERIES

Renk Seçenekleri / Color Options

Mat Çelikli / Matt Silver, Mat Altın / Matt Gold, Mat Bronz / Matt Bronze, Paslanmaz Çelikli / Brushed Silver, Paslanmaz Altın / Brushed Gold, Paslanmaz Bronz / Brushed Bronze

Seramik Dış Köşe Profili / Exterior Tile Trim Profile

Yükseklik / Height	8mm - 10mm - 12mm
Uzunluk / Length	2,44 m
Materyal / Material	Paslanmaz Çelik Stainless Steel



KP SS SERIES

Renk Seçenekleri / Color Options

Mat Çelikli / Matt Silver, Mat Altın / Matt Gold, Mat Bronz / Matt Bronze, Paslanmaz Çelikli / Brushed Silver, Paslanmaz Altın / Brushed Gold, Paslanmaz Bronz / Brushed Bronze

Seramik Dış Köşe Profili / Exterior Tile Trim Profile

Yükseklik / Height	10mm - 12mm - 15mm
Genişlik / Width	20mm - 25mm - 36mm
Uzunluk / Length	2,44 m
Materyal / Material	Paslanmaz Çelik / Stainless Steel



SI SS SERIES

Renk Seçenekleri / Color Options

Mat Çelikli / Matt Silver, Mat Altın / Matt Gold, Mat Bronz / Matt Bronze, Paslanmaz Çelikli / Brushed Silver, Paslanmaz Altın / Brushed Gold, Paslanmaz Bronz / Brushed Bronze

Seramik İç Köşe Profili / Interior Tile Trim Profile

Yükseklik / Height	10mm - 12mm
Uzunluk / Length	2,44 m
Materyal / Material	Paslanmaz Çelik Stainless Steel



SI-2 SS SERIES

Renk Seçenekleri / Color Options

Mat Çelikli / Matt Silver, Mat Altın / Matt Gold, Mat Bronz / Matt Bronze, Paslanmaz Çelikli / Brushed Silver, Paslanmaz Altın / Brushed Gold, Paslanmaz Bronz / Brushed Bronze

Seramik İç Köşe Profili / Interior Tile Trim Profile

Yükseklik / Height	10mm - 12mm
Uzunluk / Length	2,44 m
Materyal / Material	Paslanmaz Çelik Stainless Steel

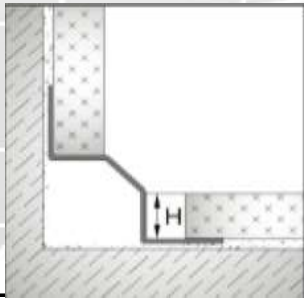

IK SS SERIES

Renk Seçenekleri / Color Options

Mat Çelikli / Matt Silver, Mat Altın / Matt Gold, Mat Bronz / Matt Bronze, Paslanmaz Çelikli / Brushed Silver, Paslanmaz Altın / Brushed Gold, Paslanmaz Bronz / Brushed Bronze

Seramik İç Köşe Profili / Interior Tile Trim Profile

Yükseklik / Height	10mm - 12mm
Uzunluk / Length	2,44 m
Materyal / Material	Paslanmaz Çelik Stainless Steel





KAFES GROUP
Ostim Osb Mh. 1568 Cd. No:51
06374 Yenimahalle/Ankara/Turkey
Tel.:+90 (0) 535 248 97 85
WEB.: www.kafesgroup.com
EMAIL.: info@kafesgroup.com

KAFES GROUP PROFILE SYSTEMS

Köşe Koruma Profilleri / Corner Guard Profiles

KP SERIES

Köşe Koruma Profili / Corner Guard Profile

Genişlik / Width 20x20mm / 30x30mm
40x40mm / 50x50mm

Uzunluk / Length 3,00 m

Materyal / Material Elokсалlı Alüminyum /
Anodised Aluminium

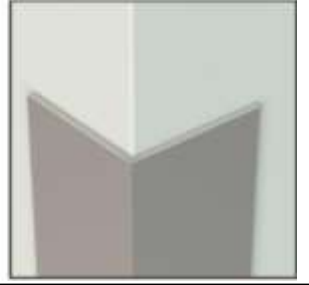
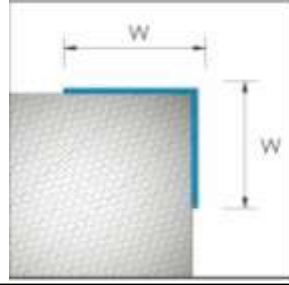

KPP SERIES

Köşe Koruma Profili / Corner Guard Profile

Genişlik / Width 15x15mm / 25x25mm
50x50mm

Uzunluk / Length 3,00 m

Materyal / Material Elokсалlı Alüminyum /
Anodised Aluminium

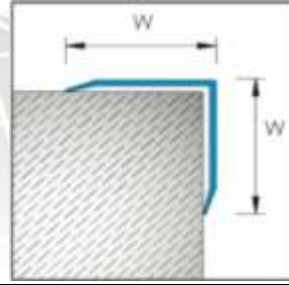

Paslanmaz Köşe Koruma Profilleri / Stainless Steel Corner Guard Profiles

KP SS SERIES

Köşe Koruma Profili / Corner Guard Profile

Genişlik / Width 20x20mm / 30x30mm
40x40mm / 50x50mm

Uzunluk / Length 3,00 m

Materyal / Material Paslanmaz Çelik
Stainless Steel

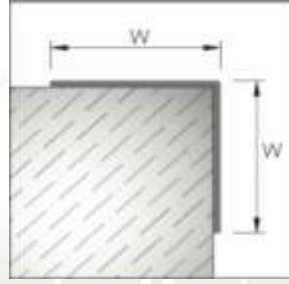

KPP SS SERIES

Köşe Koruma Profili / Corner Guard Profile

Genişlik / Width 15x15mm / 25x25mm
50x50mm

Uzunluk / Length 2,44 m

Materyal / Material Paslanmaz Çelik
Stainless Steel

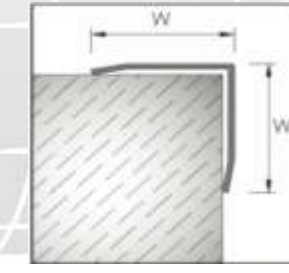

Küvet Kenar Profili / Bathtub Profile

KK 30/50

Küvet Kenar Profili / Bathtub Profile

Genişlik / Width 30 - 50 mm

Uzunluk / Length 2,5 m

Materyal / Material PVC
PVC

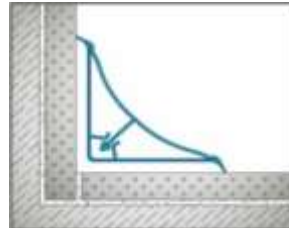



KAFES GROUP
Ostim Osb Mh. 1568 Cd. No:51
06374 Yenimahalle/Ankara/Turkey
Tel.:+90 (0) 535 248 97 85
WEB.: www.kafesgroup.com
EMAIL.: info@kafesgroup.com

KAFES GROUP PROFILE SYSTEMS

Bordür Profilleri / Border Profiles

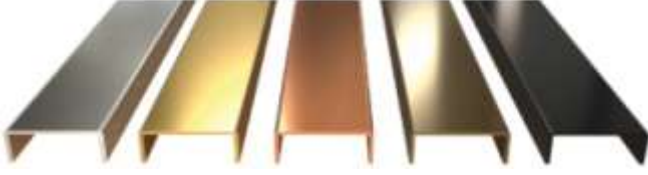

Bordür profilleri alüminyum ve paslanmaz çelik alternatifleri ile mekanizmalara şık ve dekoratif bir görünüm kazandırır. İstenilen renk ve ölçülerde özel üretim yapılarak proje bazlı çözümler sunulur.

Border Profiles bring an elegant and decorative look to the places with aluminium and stainless steel options. Project-based solutions are offered by making special production in desired colors and size.

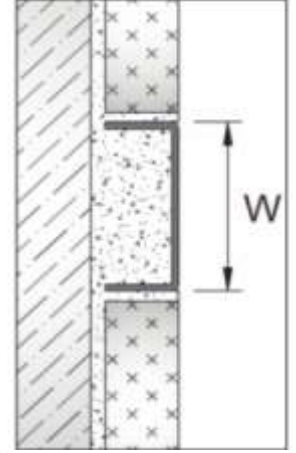
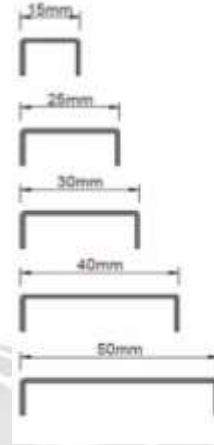

Seramik Tesviye Sistemi / Ceramic Levelling System



seramik tesviye sistemi Seramik fayans ve granit uygulamalarınızda oluşabilecek yüksek farklarının düzeltilmesinde kullanır seramiklerin uygulanması esnasında mükemmel bir hizalama yaparak düzgün bir görünüm verir seramik desteğe sistemi derz artık litrelik ama takozları ve ayarlanabilir pençe olmak üzere 3 parçadan oluşur derz artık klipleri 88 milimetreden 14 milimetreye kadar parça Seramik fayans kalınlıklarına uygun olarak tasarlanmıştır sistemimizde bulunan ayarlanabilir pense sayesinde K motorları Hızlı ve kolay bir şekilde uygulanabilir ve birden çok sefer kullanılabilir.

Ceramic Levelling System gives you an easy way for making files, ceramics and granites by stopping differences in the elevation between the edges. it helps to make superb leveling of the ceramics and tiles expending the installation as well. ceramic Leveling System is advised for thin, large, heavy and flexible files and the system have 3 parts as spacer clips, pillar and wedges. our spaces clips are specially designed for different ceramic thicknesses as 8 mm to 14 mm. the wedges are specially designed for constant use they have a quality material for this kind of using. our system has an adjustable pillar which is recommended for making the installation faster and inserting the edges easier; the pressure ceramics can be regulated helping by this pillar.

Derz Artıları / Tile Spaces

Genişlik / Width 1mm - 2mm - 3mm
Renk / Color Beyaz / White
Materyal / Material PVC

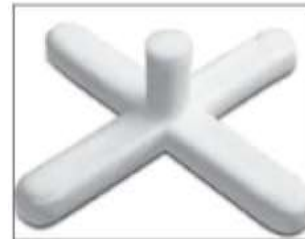



KAFES GROUP
Ostim Osb Mh. 1568 Cd. No:51
06374 Yenimahalle/Ankara/Turkey
Tel.:+90 (0) 535 248 97 85
WEB.: www.kafesgroup.com
EMAIL.: info@kafesgroup.com

KAFES GROUP PROFILE SYSTEMS

Genleşme Derz Profilleri / Movement Joint Profiles

GD 15   

Genleşme Derz Profilleri / Movement Joint Profiles

Yükseklik / Height 15mm
Uzunluk / Length 10mm - 12mm
Materyal / Material Alu. Profil + Fitol
Alu Profile + Insert



GD 10   

Genleşme Derz Profilleri / Movement Joint Profiles

Yükseklik / Height 10mm
Uzunluk / Length 10mm - 12mm
Materyal / Material Alu. Profil + Fitol
Alu Profile + Insert



GD 23   

Genleşme Derz Profilleri / Movement Joint Profiles

Yükseklik / Height 23mm
Uzunluk / Length 15mm
Materyal / Material Alu. Profil + Fitol
Alu Profile + Insert



GD 08   

Genleşme Derz Profilleri / Movement Joint Profiles

Yükseklik / Height 8mm
Uzunluk / Length 8mm - 10mm - 12mm - 15mm
Materyal / Material PVC



GD 08   

Genleşme Derz Profilleri / Movement Joint Profiles

Yükseklik / Height 8mm
Uzunluk / Length 30mm - 50mm
Materyal / Material PVC



GB SERIES   

Genleşme Derz Profilleri / Movement Joint Profiles

Yükseklik / Height 3mm - 5mm
Uzunluk / Length 12mm - 22mm - 30mm
Materyal / Material Polıscıllı Pırınç
Polished Brass









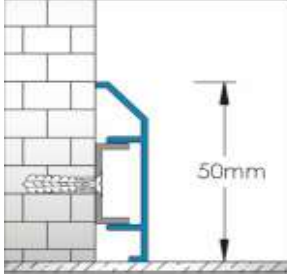

KAFES GROUP
Ostim Osb Mh. 1568 Cd. No:51
06374 Yenimahalle/Ankara/Turkey
Tel.:+90 (0) 535 248 97 85
WEB.: www.kafesgroup.com
EMAIL.: info@kafesgroup.com

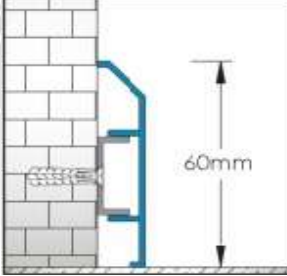

KAFES GROUP PROFILE SYSTEMS

Alüminyum Süpürgelik Profilleri / Aluminium Skirting Profiles

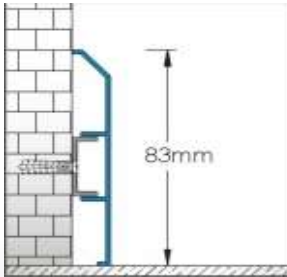
SP 50			
Genişlik / Width	50mm		
Uzunluk / Length	3,00 m		
Renk Color	Eloksal Renkleri veya Ral Kodları Anodised or Ral Colors		
Materyal Material	Alüminyum Aluminium		
Aksesuarlar Accessories	İç Köşe - Dış Köşe - Sağ Bitim - Sol Bitim Aparatları Inside-Outside Turning and Right-Left Ending		

SP 60			
Genişlik / Width	60mm		
Uzunluk / Length	3,00 m		
Renk Color	Eloksal Renkleri veya Ral Kodları Anodised or Ral Colors		
Materyal Material	Alüminyum Aluminium		
Aksesuarlar Accessories	İç Köşe - Dış Köşe - Sağ Bitim - Sol Bitim Aparatları Inside-Outside Turning and Right-Left Ending		

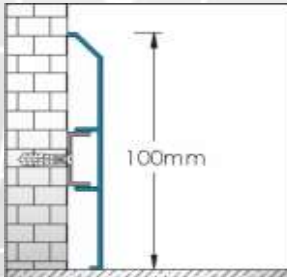
SP 83			
Genişlik / Width	83mm		
Uzunluk / Length	3,00 m		
Renk Color	Eloksal Renkleri veya Ral Kodları Anodised or Ral Colors		
Materyal Material	Alüminyum Aluminium		
Aksesuarlar Accessories	İç Köşe - Dış Köşe - Sağ Bitim - Sol Bitim Aparatları Inside-Outside Turning and Right-Left Ending		

SP 100			
Genişlik / Width	100mm		
Uzunluk / Length	3,00 m		
Renk Color	Eloksal Renkleri veya Ral Kodları Anodised or Ral Colors		
Materyal Material	Alüminyum Aluminium		









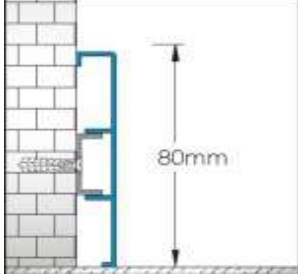

KAFES GROUP
Ostim Osb Mh. 1568 Cd. No:51
06374 Yenimahalle/Ankara/Turkey
Tel.:+90 (0) 535 248 97 85
WEB.: www.kafesgroup.com
EMAIL.: info@kafesgroup.com

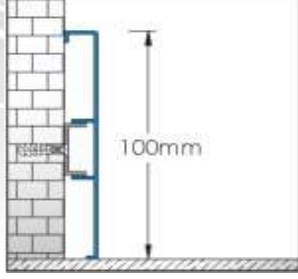

KAFES GROUP PROFILE SYSTEMS

Alüminyum Süpürgelik Profilleri / Aluminium Skirting Profiles

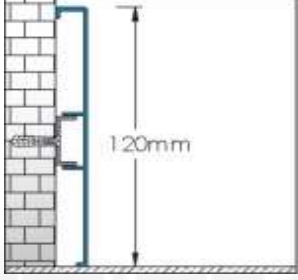
SP 80		
Genişlik / Width	80mm	
Uzunluk / Length	3,00 m	
Renk	Eloksal Renkleri veya Ral Kodları	
Color	Anodised or Ral Colors	
Materyal	Alüminyum	
Material	Aluminium	
Aksesuarlar	İç Köşe - Dış Köşe - Sağ Bitim - Sol Bitim Aparatları	
Accessories	Inside-Outside Turning and Right-Left Ending	

SP 101		
Genişlik / Width	100mm	
Uzunluk / Length	3,00 m	
Renk	Eloksal Renkleri veya Ral Kodları	
Color	Anodised or Ral Colors	
Materyal	Alüminyum	
Material	Aluminium	
Aksesuarlar	İç Köşe - Dış Köşe - Sağ Bitim - Sol Bitim Aparatları	
Accessories	Inside-Outside Turning and Right-Left Ending	

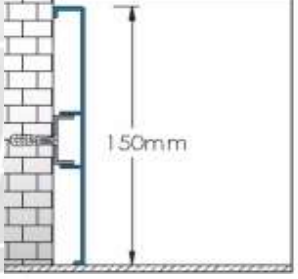
SP 120		
Genişlik / Width	120mm	
Uzunluk / Length	3,00 m	
Renk	Eloksal Renkleri veya Ral Kodları	
Color	Anodised or Ral Colors	
Materyal	Alüminyum	
Material	Aluminium	
Aksesuarlar	İç Köşe - Dış Köşe - Sağ Bitim - Sol Bitim Aparatları	
Accessories	Inside-Outside Turning and Right-Left Ending	

SP 150		
Genişlik / Width	100mm	
Uzunluk / Length	3,00 m	
Renk	Eloksal Renkleri veya Ral Kodları	
Color	Anodised or Ral Colors	
Materyal	Alüminyum	
Material	Aluminium	
Aksesuarlar	İç Köşe - Dış Köşe - Sağ Bitim - Sol Bitim Aparatları	
Accessories	Inside-Outside Turning and Right-Left Ending	





KAFES GROUP
Ostim Osb Mh. 1568 Cd. No:51
06374 Yenimahalle/Ankara/Turkey
Tel.:+90 (0) 535 248 97 85
WEB.: www.kafesgroup.com
EMAIL.: info@kafesgroup.com

KAFES GROUP PROFILE SYSTEMS

Alüminyum Süpürgelik Profilleri / Aluminium Skirting Profiles

SP 90	
Genişlik / Width	90mm
Uzunluk / Length	3,00 m
Renk	Eloksal Renkleri veya Ral Kodları
Color	Anodised or Ral Colors
Materyal	Alüminyum
Material	Aluminium
Aksesuarlar	İç Köşe - Dış Köşe - Sağ Bitim - Sol Bitim Aparatları
Accessories	Inside-Outside Turning and Right-Left Ending

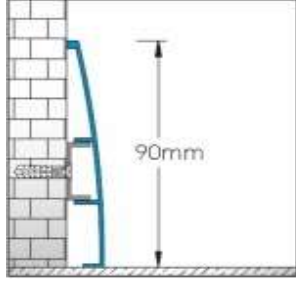

Sol Bitim Aparatı
Left Ending

Dış Köşe Aparatı
Outside Turning

İç Köşe Aparatı
Inside Turning

Sağ Bitim Aparatı
Right Ending

SP 51	
Genişlik / Width	100mm
Uzunluk / Length	3,00 m
Renk	Eloksal Renkleri veya Ral Kodları
Color	Anodised or Ral Colors
Materyal	Alüminyum
Material	Aluminium

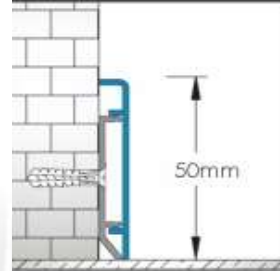

SP 82	
Genişlik / Width	80mm
Uzunluk / Length	3,00 m
Renk	Eloksal Renkleri veya Ral Kodları
Color	Anodised or Ral Colors
Materyal	Alüminyum
Material	Aluminium

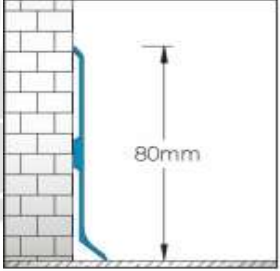

SP 102	
Genişlik / Width	100mm
Uzunluk / Length	3,00 m
Renk	Eloksal Renkleri veya Ral Kodları
Color	Anodised or Ral Colors
Materyal	Alüminyum
Material	Aluminium

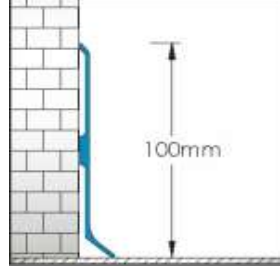







KAFES GROUP
Ostim Osb Mh. 1568 Cd. No:51
06374 Yenimahalle/Ankara/Turkey
Tel.:+90 (0) 535 248 97 85
WEB.: www.kafesgroup.com
EMAIL.: info@kafesgroup.com

KAFES GROUP PROFILE SYSTEMS

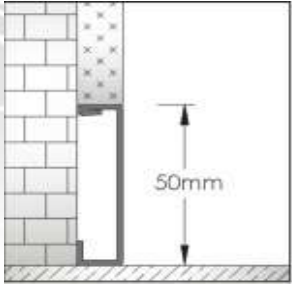
Paslanmaz Çelik Süpürgelik Profilleri / Stainless Steel Skirting Profiles

SP 50 SS		Paslanmaz Çelik Renk Seçenekleri / Color Options for Stainless Steel							
		Mat Gümüşü	Mat Altın	Mat Bronz	Parlak Gümüşü	Parlak Altın	Parlak Bronz		
Genişlik / Width	50mm								
Uzunluk / Length	2,50 m								
Renk	Parlak ve mat								
Color	Satinet and Polished								
Materyal	Paslanmaz Çelik								
Material	Stainless Steel								

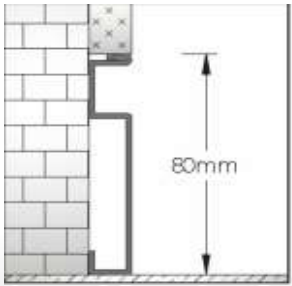
SP 51 SS			
Genişlik / Width	50mm		
Uzunluk / Length	2,50 m		
Renk	Parlak ve mat		
Color	Satinet and Polished		
Materyal	Paslanmaz Çelik		
Material	Stainless Steel		

SP 80 SS			
Genişlik / Width	80mm		
Uzunluk / Length	2,50 m		
Renk	Parlak ve mat		
Color	Satinet and Polished		
Materyal	Paslanmaz Çelik		
Material	Stainless Steel		

SP 82 SS			
Genişlik / Width	80mm		
Uzunluk / Length	2,50 m		
Renk	Parlak ve mat		
Color	Satinet and Polished		
Materyal	Paslanmaz Çelik		
Material	Stainless Steel		





SP 102 SS			
Genişlik / Width	100mm		
Uzunluk / Length	2,50 m		
Renk	Parlak ve mat		
Color	Satinet and Polished		
Materyal	Paslanmaz Çelik		
Material	Stainless Steel		

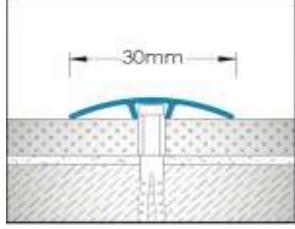

KAFES GROUP
Ostim Osb Mh. 1568 Cd. No:51
06374 Yenimahalle/Ankara/Turkey
Tel.:+90 (0) 535 248 97 85
WEB.: www.kafesgroup.com
EMAIL.: info@kafesgroup.com

KAFES GROUP PROFILE SYSTEMS

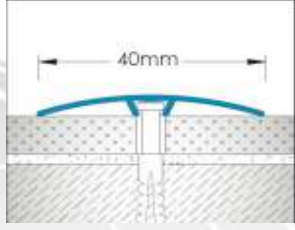
Eşik (Geçiş) Profilleri / Threshold Profiles











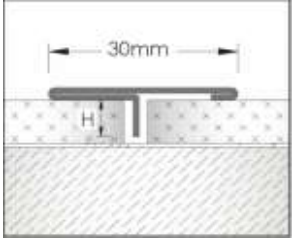

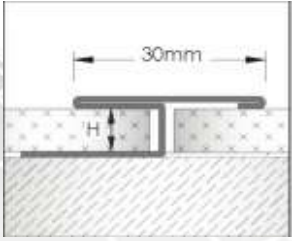
EP 30			
Genişlik / Width	30mm		
Uzunluk / Length	2,70 m		
Renk	Eloksal renkleri veya Ral Kodları		
Color	Anodised or Ral Colors		
Materyal / Material	Alüminyum / Aluminium		
EP 40			
Genişlik / Width	40mm		
Uzunluk / Length	2,70 m		
Renk	Eloksal renkleri veya Ral Kodları		
Color	Anodised or Ral Colors		
Materyal / Material	Alüminyum / Aluminium		
EP 60			
Genişlik / Width	60mm		
Uzunluk / Length	2,70 m		
Renk	Eloksal renkleri veya Ral Kodları		
Color	Anodised or Ral Colors		
Materyal / Material	Alüminyum / Aluminium		
EP 40 SS			
Genişlik / Width	40mm		
Uzunluk / Length	2,50 m		
Renk	Parlak veya mat		
Color	Satinet or Polished		
Materyal / Material	Paslanmaz Çelik / Stainless Steel		
UT SERIES			
Genişlik / Width	15mm - 20mm - 25mm - 30mm		
Uzunluk / Length	2,50 m		
Renk	Eloksal renkleri veya Ral Kodları		
Color	Anodised or Ral Colors		
Materyal / Material	Alüminyum / Aluminium		
AT 30			
Yükseklik / Height	8,5mm		
Genişlik / Width	30mm		
Uzunluk / Length	2,70 m		
Renk	Eloksal renkleri veya Ral Kodları		
Color	Anodised or Ral Colors		
Materyal / Material	Alüminyum / Aluminium		

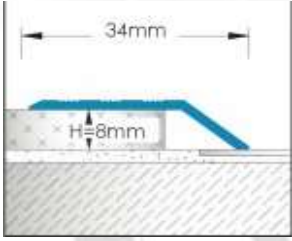

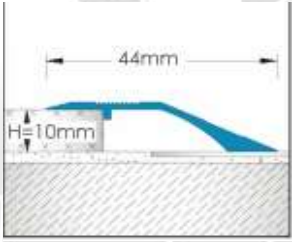
KAFES GROUP
Ostim Osb Mh. 1568 Cd. No:51
06374 Yenimahalle/Ankara/Turkey
Tel.:+90 (0) 535 248 97 85
WEB.: www.kafesgroup.com
EMAIL.: info@kafesgroup.com

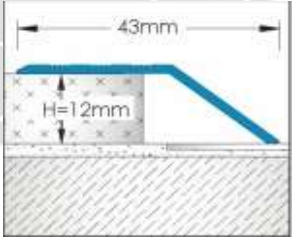
KAFES GROUP PROFILE SYSTEMS

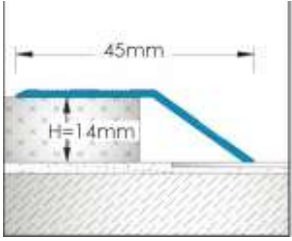
Kot Farkı Profilleri / Level Difference Trim Profiles



UT SS			
Yükseklik / Height	7mm		
Genişlik / Width	30mm		
Uzunluk / Length	2,50 m		
Renk	Parlak veya mat		
Color	Satinet or Polished		
Materyal / Material	Paslanmaz Çelik / Stainless Steel		
AT SS			
Yükseklik / Height	8,5mm - 14mm - 16mm		
Genişlik / Width	30mm		
Uzunluk / Length	2,50 m		
Renk	Parlak veya mat		
Color	Satinet or Polished		
Materyal / Material	Paslanmaz Çelik / Stainless Steel		
KF 34			
Yükseklik / Height	8mm		
Genişlik / Width	34mm		
Uzunluk / Length	2,70 m		
Renk	Eloksal renkleri veya Ral Kodları		
Color	Anodised or Ral Colors		
Materyal / Material	Alüminyum / Aluminium		
KF 44			
Yükseklik / Height	10mm		
Genişlik / Width	44mm		
Uzunluk / Length	2,70 m		
Renk	Eloksal renkleri veya Ral Kodları		
Color	Anodised or Ral Colors		
Materyal / Material	Alüminyum / Aluminium		
KF 43			
Yükseklik / Height	10mm		
Genişlik / Width	43mm		
Uzunluk / Length	2,70 m		
Renk	Eloksal renkleri veya Ral Kodları		
Color	Anodised or Ral Colors		
Materyal / Material	Alüminyum / Aluminium		
KF 45			
Yükseklik / Height	14mm		
Genişlik / Width	45mm		
Uzunluk / Length	2,70 m		
Renk	Eloksal renkleri veya Ral Kodları		
Color	Anodised or Ral Colors		
Materyal / Material	Alüminyum / Aluminium		





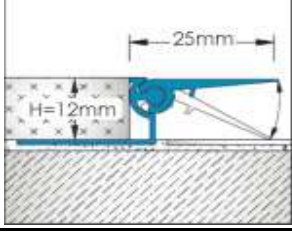

KAFES GROUP
Ostim Osb Mh. 1568 Cd. No:51
06374 Yenimahalle/Ankara/Turkey
Tel.:+90 (0) 535 248 97 85
WEB.: www.kafesgroup.com
EMAIL.: info@kafesgroup.com

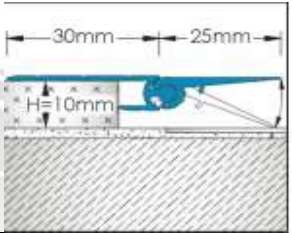

KAFES GROUP PROFILE SYSTEMS

Kot Farkı Profilleri / Level Difference Trim Profiles

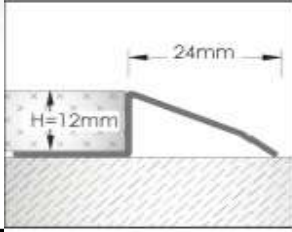

KF 25 SERIES			
Yükseklik / Height	10mm - 12mm		
Genişlik / Width	25mm		
Uzunluk / Length	2,70 m		
Materyal	Eloksallı Alüminyum		
Material	Anodised Aluminium		

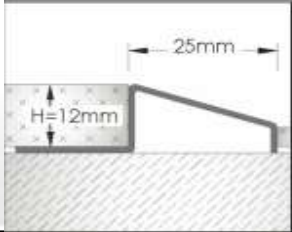

KF 27 H10			
Yükseklik / Height	10mm		
Genişlik / Width	55mm		
Uzunluk / Length	2,70 m		
Materyal	Eloksallı Alüminyum		
Material	Anodised Aluminium		

KF 24 SS			
Yükseklik / Height	12mm		
Genişlik / Width	24mm		
Uzunluk / Length	2,50 m		
Materyal	Paslanmaz Çelik		
Material	Stainless Steel		

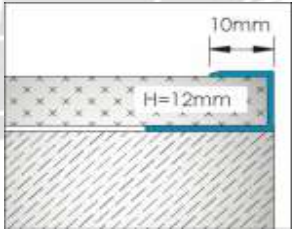
KF 25 SS			
Yükseklik / Height	12mm		
Genişlik / Width	25mm		
Uzunluk / Length	2,50 m		
Materyal	Paslanmaz Çelik		
Material	Stainless Steel		

Parke ve Halı Bitim Profilleri / Parquet and Carpet Edge Trim Profiles

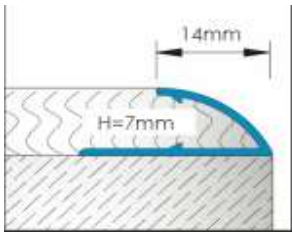
PB 08			
Yükseklik / Height	8,5mm - 16mm		
Genişlik / Width	10mm - 16mm		
Uzunluk / Length	2,70 m		
Materyal	Eloksallı Alüminyum		
Material	Anodised Aluminium		











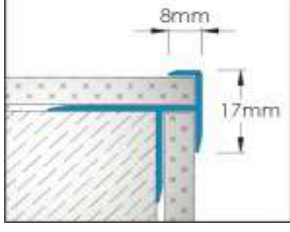

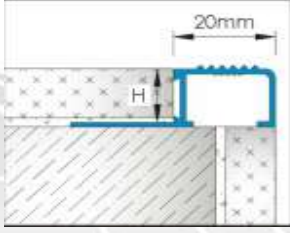
HB 14			
Yükseklik / Height	7mm		
Genişlik / Width	14mm		
Uzunluk / Length	2,70 m		
Materyal	Eloksallı Alüminyum		
Material	Anodised Aluminium		

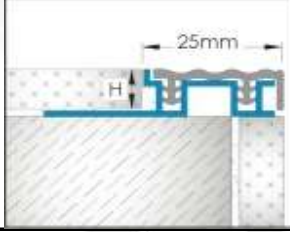

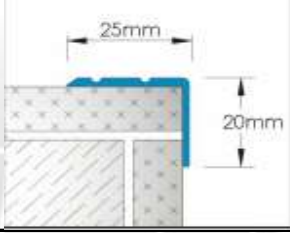
KAFES GROUP
Ostim Osb Mh. 1568 Cd. No:51
06374 Yenimahalle/Ankara/Turkey
Tel.:+90 (0) 535 248 97 85
WEB.: www.kafesgroup.com
EMAIL.: info@kafesgroup.com

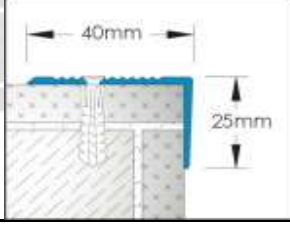
KAFES GROUP PROFILE SYSTEMS

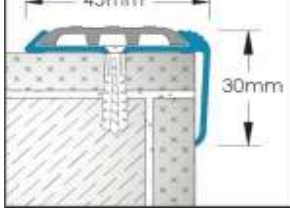
Merdiven Burun Profilleri / Stair Nosing Profiles

MP 0817			
Genişlik / Width	8mm x 17mm		
Yükseklik / Height	8,5mm		
Uzunluk / Length	2,70 m		
Materyal	Eloksallı Alüminyum		
Material	Anodised Aluminium		
MP 20			
Genişlik / Width	20mm		
Yükseklik / Height	10-12mm		
Uzunluk / Length	2,70 m		
Materyal	Eloksallı Alüminyum		
Material	Anodised Aluminium		
MP 25			
Genişlik / Width	25mm		
Yükseklik / Height	10mm - 12mm		
Materyal	Alu Profil + PVC Fitil		
Material	Alu Profile + Insert		
			
MP 2520			
Genişlik / Width	25mm x 20mm		
Uzunluk / Length	2,70 m		
Materyal	Eloksallı Alüminyum		
Material	Anodised Aluminium		
MP 4025			
Genişlik / Width	40mm x 25mm		
Uzunluk / Length	2,70 m		
Materyal	Eloksallı Alüminyum		
Material	Anodised Aluminium		
MP 4530			
Genişlik / Width	45mm x 30mm		
Uzunluk / Length	2,70 m		
Materyal	Eloksallı Alüminyum		
Material	Anodised Aluminium		



KAFES GROUP
Ostim Osb Mh. 1568 Cd. No:51
06374 Yenimahalle/Ankara/Turkey
Tel.:+90 (0) 535 248 97 85
WEB.: www.kafesgroup.com
EMAIL.: info@kafesgroup.com

KAFES GROUP PROFILE SYSTEMS

Merdiven Burun Profilleri / Stair Nosing Profiles

MP 5532			
Genişlik / Width	55mm x 32mm		
Uzunluk / Length	2,70 m - 3,00 m		
Materyal	Eloksallı Alüminyum + Kaydırmaz Bant		
Material	Anodised Aluminium + Anti-Slip Tape		

MP 7532			
Genişlik / Width	75mm c 32mm		
Uzunluk / Length	2,70 m - 3,00 m		
Materyal	Eloksallı Alüminyum + Kaydırmaz Bant		
Material	Anodised Aluminium + Anti-Slip Tape		

LED Işıklı Merdiven Burun Profilleri / LED Light Stair Nosing Profiles

Genişlik / Width	73mm		
Uzunluk / Length	42mm		
Materyal	Eloksallı Alüminyum + Kaydırmaz Bant		
Material	Anodised Aluminium + Anti-Slip Tape		
<p>Özellikle Konferans Salonları ve Sinema Salonları için tasarlanmış olan LED IŞIKLI ALÜMİNYUM MERDİVEN PROFİLİ karanlık ortamlarda yön bulunmasına yardımcı olur ve merdivenlerin güvenli kullanımını sağlar.</p> <p>Stair Nosing Profiles with LED Lights, that are especially created for Conference and Cinema Halls, help to obtain directions and provide safety for the stairs.</p>			





KAFES GROUP
Ostim Osb Mh. 1568 Cd. No:51
06374 Yenimahalle/Ankara/Turkey
Tel.:+90 (0) 535 248 97 85
WEB.: www.kafesgroup.com
EMAIL.: info@kafesgroup.com

KAFES GROUP PROFILE SYSTEMS

Kaydırmazlık Bantları / Anti-Slip Tape

KULLANIM ALANLARI

İç ve Dış Mekanlardaki merdivenlerde, kaygan zeminlerde, otobüs ve kamyon basamaklarında, fabrikalarda, okullarda, alışveriş merkezlerinde, yüzme havuzlarında, deniz botlarında uygulanır.

UYGULAMA

- Yapıştırılacak zeminin, temiz ve kuru olmasına dikkat edilmelidir.
- Yapıştırma işlemi sırasında zeminin ısıtılması maksimum tutuculuk sağlar.
- 10°C altında uygulanmamalıdır.

USAGE AREAS

They are applied on stairs, slippery grounds, bus and truck treads, factories, schools, shopping centers, pools and marine boots in indoor and outdoor places.

APPLICATION

- The ground to be adhered to should be clean and dry.
- During the bonding process heating the floor provides maximum restaint.
- Do not apply below 10°C



MP 7532

Genişlik / Width	25mm - 50mm
Uzunluk / Length	25m Rulo
Materyal	Karborundum
Material	Carborundum

KAFES

Renkler / Colors



Siyah / Black



Gril / Gray



Sarı - Siyah / Yellow-Black



Kırmızı / Red



Fosforlu / Luminous



Mavi / Blue

Kaydırmazlık Fitilleri / Anti-Slip Strips

Genişlik / Width	11mm
Uzunluk / Length	7mm
Materyal	PVC
Material	PVC

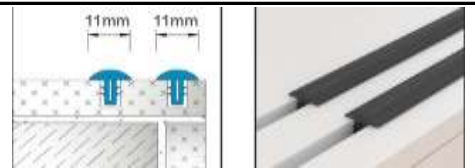



KAFES GROUP
Ostim Osb Mh. 1568 Cd. No:51
06374 Yenimahalle/Ankara/Turkey
Tel.:+90 (0) 535 248 97 85
WEB.: www.kafesgroup.com
EMAIL.: info@kafesgroup.com

KAFES GROUP PROFILE SYSTEMS

Hijyenik Paspas / Hygienic Doormat

Hijyenik Paspası Kullanım Yerleri:

İş yerleri, apartman girişleri, Hastane Girişleri, Ameliyathane Girişleri, Doktor, Diş Helimi, Veteriner klinikleri, sosyal tesisler, soyunma odaları, okullar, wc çıkışları gibi hijyen havuzlu paspas hijyen isteniler tüm yaşam alanlarında kullanılabilir.

Hijyen Paspası Özellikleri:

- * Dezenfektan Sıvısı Hazne İçinde Muhafaza Eder ve Hazne içerisindeki kıvrıkcık paspas yardımıyla ayakkabı tabanına sterilizasyon uygulayarak bakteri ve organizmaların içeri girmesini engeller.
- * Dış ortamdan gelen hastalıkların önlenmesine yardımcı olur.
- * Çerçeve olarak kullandığımız özel tasarlanmış kot giderici alüminyum profil sayesinde ayak takılmaz
- * Estetik görüntüsü ile mekanlarınıza prestij kazandırır.

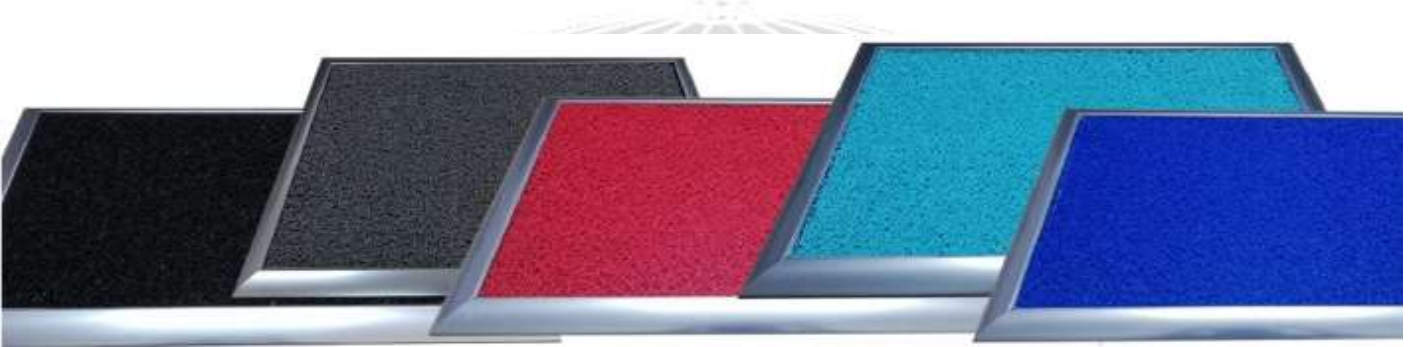

Hygienic Doormat Usage Areas:

They can be used all hygiene-required areas as Workplaces, Apartment, Hospital and Surgery Room Entrances, Doctor, Dentist and Vet Clinics, Recreational Facilities, Changing Rooms, Schools, Rest Room Exits, Features of.

Hygienic Doormat:

They keep the disinfectant liquid inside and stops bacteria and microorganisms at the entrance by sterilizing the treads of shoes by the help of curled material inside the reservoir. Avoids illnesses coming from outside with shoes. the shoes are not caught against the doormat thanks to specifically designed aluminium profile used as frame. Ensures prestige to your buildings with its aesthetic aspect.



İç Mekan Paspas Sistemleri
Indoor Doormat Systems



Dönder Kapı Paspas Sistemleri
Circular Doormat Systems



KAFES GROUP
Ostim Osb Mh. 1568 Cd. No:51
06374 Yenimahalle/Ankara/Turkey
Tel.:+90 (0) 535 248 97 85
WEB.: www.kafesgroup.com
EMAIL.: info@kafesgroup.com

KAFES GROUP PROFILE SYSTEMS

Alüminyum Paspas Sistemleri / Aluminium Doormat Systems

- Alüminyum paspas sistemleri toz ve nemin mekanlarınıza girişini engeller, aşınma ve yıpranmayı önemli ölçüde azaltır zemin malzemesinin ömrünü uzatır.
- Aluminium Doormat Systems prevent dirt, dust and moisture from entering your spaces. Significantltly reduces wear and tear, extends the life of the floor material.
- Yüksek verim sağlar, Mekanlarınıza prestij kazandırır, Kolaylıkla yerinden kaldırılıp Elektrikli süpürge, fırça yada tazyikli su ile temizlenebilir.
- It provides high efficiency, it gives prestige to your places. They can be removed and cleaned with a vacuum cleaner, brush or pressurised water.
- Alüminyum Paspas sistemlerimiz kot giderici çerçeve ve havuz çerçeve olarak iki farklı çerçeve sistemine sahiptir.
- Our aluminium mat systems have two different frame systems as levelling and recessing frame.
- Uygulanacak zeminde paspasın içine girebileceği bir havuz açılmış ise havuz çerçeve tercih edilir.
- Recessing frame is preferred if there is an available space left on the where the doormat will be placed.
- Paspas direkt olarak zemin malzemesinin üzerine uygulanacaksa ayak takılmalarını önlemek için kot giderici çerçeve ile üretilir.
- If the mat will be applied directly on the floor material, it is produced with a levelling frame to prevent foot snagging.
- Projelerinizde ve detaylarınıza özel ölçülerde yapılır.
- They are produced in special dimensions for your projects and details.

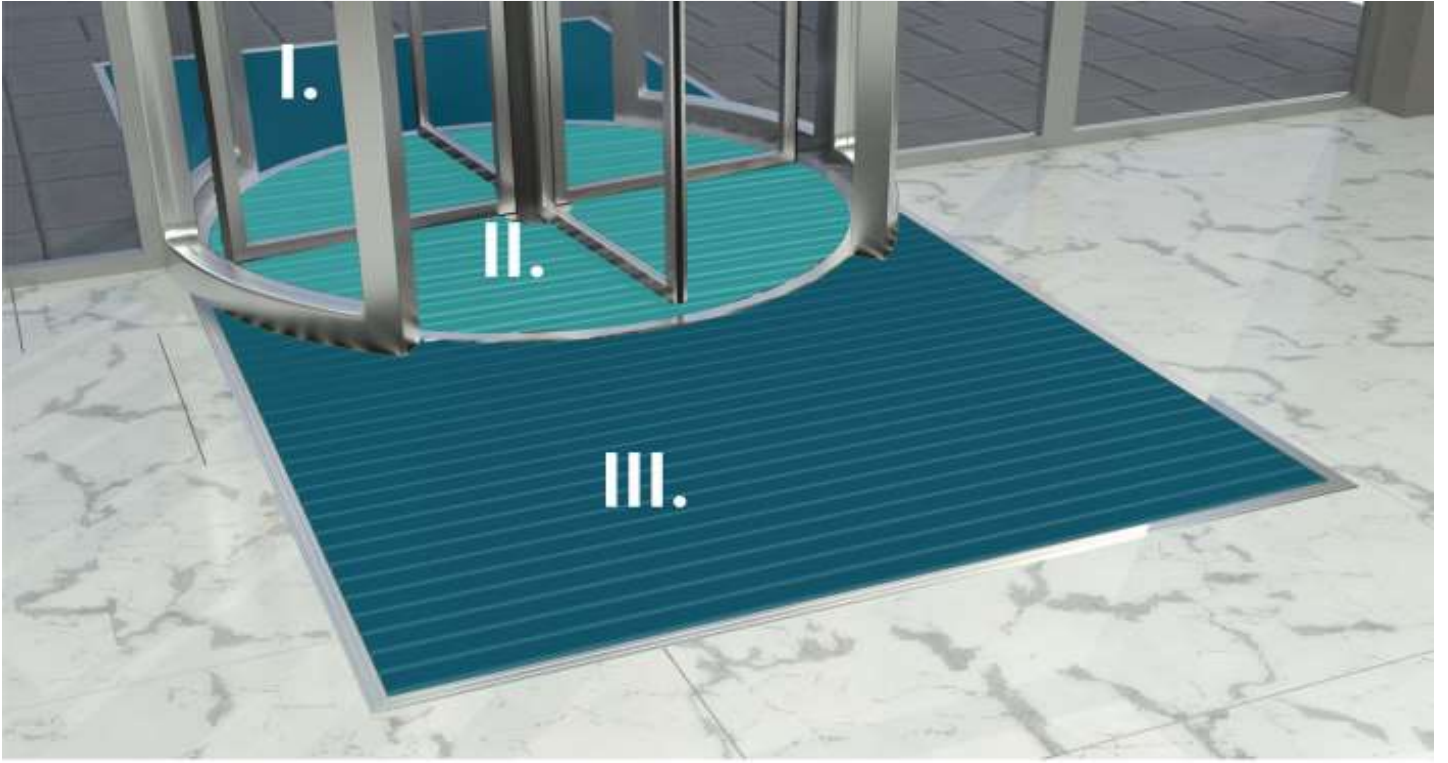

Alüminyum Paspas Sistemleri Kullanım Alanları / Aluminium Doormat Systems Usage Areas

- I. Bölge: Kaba kirlerin içeri girmesini engeller (çamur, kar, taş, vb.). Dış mekan paspas sistemleri bu bölge için kullanıma uygundur.
I.Zone: Prevents rough dirt to get in (mud, snow, stone, etc.). Outdoor Doormat Systems can be used for this area.
- II. Bölge: İnce kirlerin içeri girmesini engeller (Kum, Toz, Su, vb.). Bu bölge için hem dış mekan hemde iç mekan paspas sistemleri kullanıma uygundur.
II.Zone: Prevents thinner dirt to get in (gravel, dust, water, etc.). Both indoor and outdoor doormat systems can be used for this area.
- III. Bölge: Nemi alır ve ayak tabanını temizler. İç mekan paspas sistemleri bu bölge için kullanıma uygundur.
III.Zone: Absorbs humidity and cleans the soles of the feet. Indoor Doormat Systems can be used for this area.



KAFES GROUP
Ostim Osb Mh. 1568 Cd. No:51
06374 Yenimahalle/Ankara/Turkey
Tel.:+90 (0) 535 248 97 85
WEB.: www.kafesgroup.com
EMAIL.: info@kafesgroup.com

KAFES GROUP PROFILE SYSTEMS

Dış Mekan İnce Paspas Sistemleri / Outdoor Slim Doormat Systems

PK H15

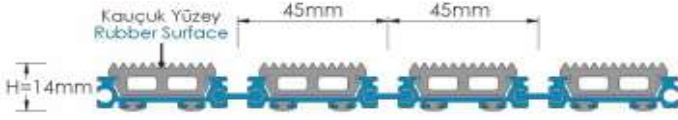

YÜSEY
SURFACE
Kauçuk
Rubber

AĞIRLIK
WIGHT
13 kg/m²

YÜKSEKLİK
HEIGHT
14 mm



PKS H15

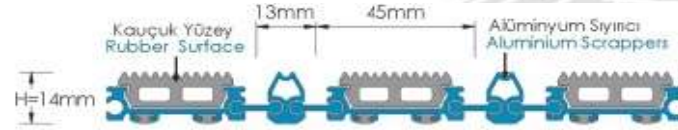

YÜSEY
SURFACE
KAUÇUK + ALÜMİNYUM
Sıyırıcı
Rubber + Aluminium

AĞIRLIK
WIGHT
11 kg/m²

YÜKSEKLİK
HEIGHT
14 mm



PKFS H15

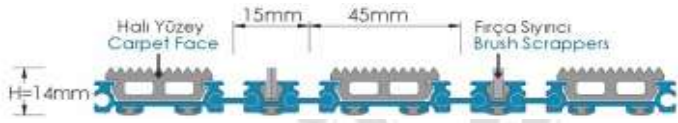

YÜSEY
SURFACE
Hali + cFırça Sıyırıcı
Carpet + Brush Scrapers

AĞIRLIK
WIGHT
12,5 kg/m²

YÜKSEKLİK
HEIGHT
14 mm



PF H15

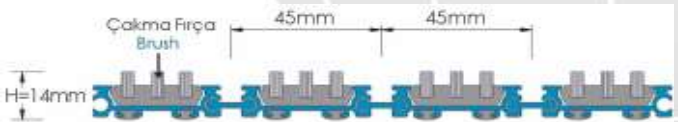

YÜSEY
SURFACE
Çakma Fırça
Brush

AĞIRLIK
WIGHT
12,8 kg/m²

YÜKSEKLİK
HEIGHT
14 mm



PKF H15

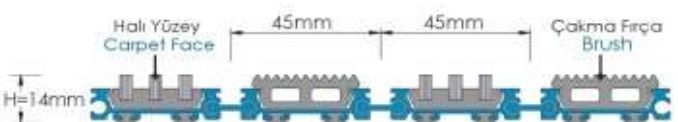

YÜSEY
SURFACE
Çakma Fırça + Kauçuk
Brush + Rubber

AĞIRLIK
WIGHT
12,5 kg/m²

YÜKSEKLİK
HEIGHT
14 mm





KAFES GROUP
Ostim Osb Mh. 1568 Cd. No:51
06374 Yenimahalle/Ankara/Turkey
Tel.:+90 (0) 535 248 97 85
WEB.: www.kafesgroup.com
EMAIL.: info@kafesgroup.com

KAFES GROUP PROFILE SYSTEMS

Dış Mekan İnce Paspas Sistemleri / Outdoor Slim Doormat Systems

PK H25

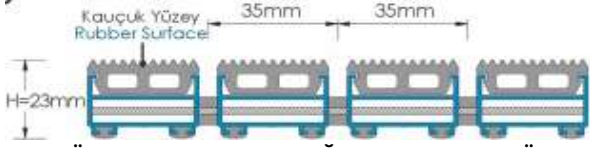

YÜSEY
SURFACE
Kauçuk
Rubber

AĞIRLIK
WIGHT
19,5 kg/m²

YÜKSEKLİK
HEIGHT
23 mm



PKS H25

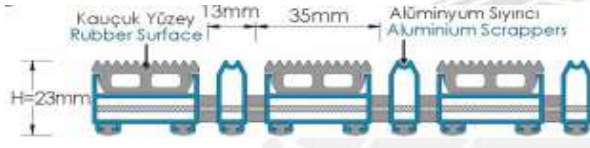

YÜSEY
SURFACE
KAUÇUK + ALÜMİNYUM
Sıyrıcı
Rubber + Aluminium

AĞIRLIK
WIGHT
17,5 kg/m²

YÜKSEKLİK
HEIGHT
23 mm

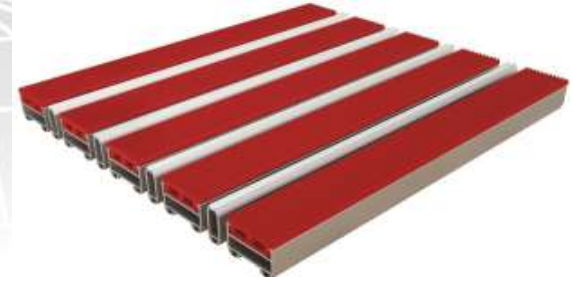

PKFS H25

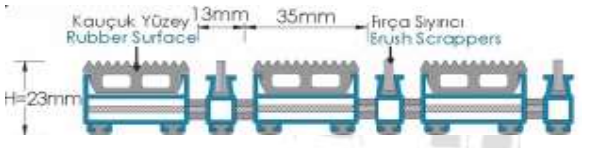

YÜSEY
SURFACE
Halı + Fırça Sıyrıcı
Carpet + Brush Scrappers

AĞIRLIK
WIGHT
19 kg/m²

YÜKSEKLİK
HEIGHT
23 mm



PF H25

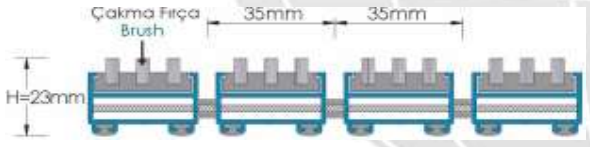

YÜSEY
SURFACE
Çakma Fırça
Brush

AĞIRLIK
WIGHT
18 kg/m²

YÜKSEKLİK
HEIGHT
23 mm



PKF H25

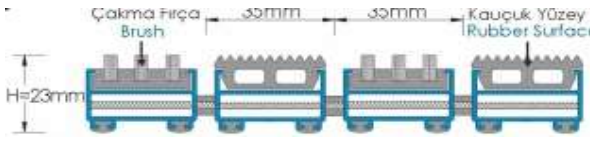

YÜSEY
SURFACE
Çakma Fırça + Kauçuk
Brush + Rubber

AĞIRLIK
WIGHT
19 kg/m²

YÜKSEKLİK
HEIGHT
23 mm





KAFES GROUP
Ostim Osb Mh. 1568 Cd. No:51
06374 Yenimahalle/Ankara/Turkey
Tel.:+90 (0) 535 248 97 85
WEB.: www.kafesgroup.com
EMAIL.: info@kafesgroup.com

KAFES GROUP PROFILE SYSTEMS

İç Mekan İnce Paspas Sistemleri / Indoor Slim Doormat Systems

PH H15

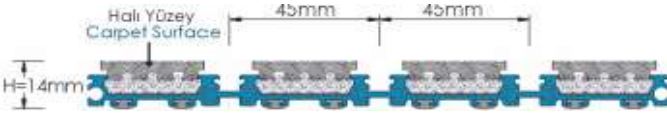

YÜSEY
SURFACE
Halı
Carpet

AĞIRLIK
WIGHT
10,5 kg/m²

YÜKSEKLİK
HEIGHT
23 mm



PHK H15

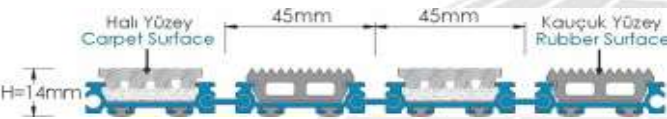

YÜSEY
SURFACE

Kauçuk + Halı
Rubber + Carpet

AĞIRLIK
WIGHT
11,75 kg/m²

YÜKSEKLİK
HEIGHT
23 mm



PHS H15

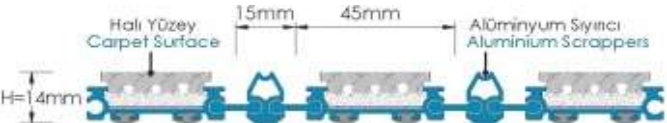

YÜSEY
SURFACE

Halı + Alüminyum Sıyrıcı
Carpet + Aluminium
Scrapers

AĞIRLIK
WIGHT
19 kg/m²

YÜKSEKLİK
HEIGHT
23 mm



PHFS H15

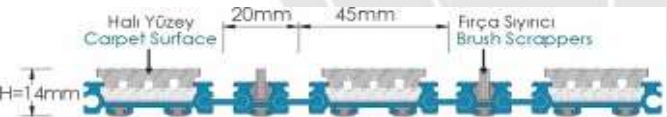

YÜSEY
SURFACE

Halı + Fırça Sıyrıcı
Carpet + Brush
Scrapers

AĞIRLIK
WIGHT
12,5 kg/m²

YÜKSEKLİK
HEIGHT
14 mm



PHF H15

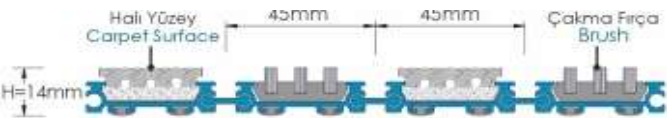

YÜSEY
SURFACE

Çakma Fırça + Halı
Brush + Carpet

AĞIRLIK
WIGHT
13 kg/m²

YÜKSEKLİK
HEIGHT
14 mm





KAFES GROUP
Ostim Osb Mh. 1568 Cd. No:51
06374 Yenimahalle/Ankara/Turkey
Tel.:+90 (0) 535 248 97 85
WEB.: www.kafesgroup.com
EMAIL.: info@kafesgroup.com

KAFES GROUP PROFILE SYSTEMS

İç Mekan İnce Paspas Sistemleri / Indoor Slim Doormat Systems

PH H25

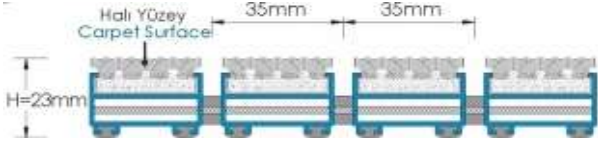

YÜSEY
SURFACE
Halı
Carpet

AĞIRLIK
WIGHT
13 kg/m²

YÜKSEKLİK
HEIGHT
23 mm



PHK H25

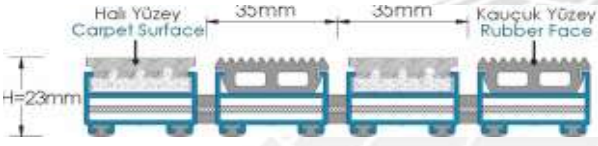

YÜSEY
SURFACE

Kauçuk + Halı
Rubber + Carpet

AĞIRLIK
WIGHT
15,5 kg/m²

YÜKSEKLİK
HEIGHT
23 mm



PHS H25

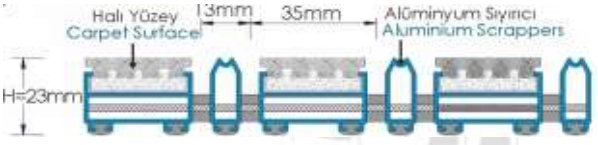

YÜSEY
SURFACE

Halı + Alüminyum Sıyrıcı
Carpet + Aluminium
Scrapers

AĞIRLIK
WIGHT
13,5 kg/m²

YÜKSEKLİK
HEIGHT
23 mm



PHFS H25

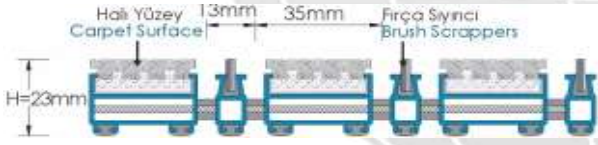

YÜSEY
SURFACE

Halı + Fırça Sıyrıcı
Carpet + Brush
Scrapers

AĞIRLIK
WIGHT
15 kg/m²

YÜKSEKLİK
HEIGHT
23 mm



PHF H25

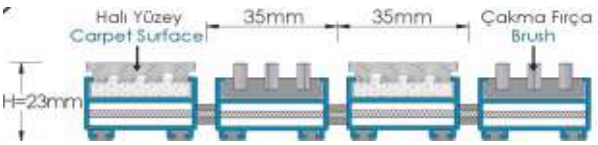

YÜSEY
SURFACE

Çakma Fırça + Halı
Brush + Carpet

AĞIRLIK
WIGHT
15,5 kg/m²

YÜKSEKLİK
HEIGHT
23 mm





KAFES GROUP
Ostim Osb Mh. 1568 Cd. No:51
06374 Yenimahalle/Ankara/Turkey
Tel.:+90 (0) 535 248 97 85
WEB.: www.kafesgroup.com
EMAIL.: info@kafesgroup.com

KAFES GROUP PROFILE SYSTEMS

Duvar Koruma Sistemleri / Crash Rail Wall Guard Systems

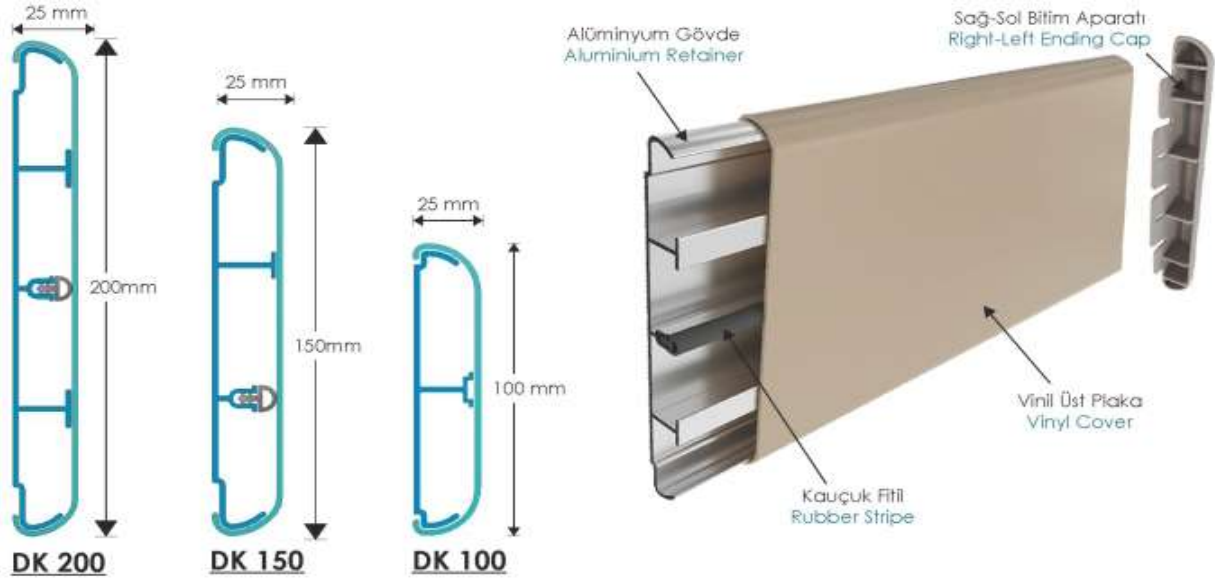

Duvar Koruma Sistemi 25mm derinliğinde 100mm, 150mm ve 200mm genişliğinde 3 farklı model olarak üretilmektedir. Sürekli alüminyum alt konstrüksiyon üzerine üst vinil kapağı takılarak oluşturulur. Vinil kapağı antibakteriyel, darbe emici, çizilmez ve yangın yürütmez özelliktedir. Alt alüminyum profil ile üst vinil kılıf arasındaki darbe emici fitil bulunmaktadır. Sistemin kendine has bitim aparatları mevcuttur. Dekorasyona uygun olarak aynı renkte veya farklı renklerde bitim aparatları seçimi yapılabilir. Uygulaması oldukça kolaydır. Alüminyum alt konstrüksiyon profili duvar yüzeyine 50-60 cm arakıklarla sabitlenir. Bitim aparatları takıldıktan sonra üst vinil kılıfı takılır. Genellikle hastanelerde sedye ve tekerlekli sandalyelerin duvar yüzeylerine çarpmalarına karşı, okullarda ve ofislerde masa-sanlaşıyelerin duvar yüzeylerine çarpmalarından oluşabilecek hasarları engellemek amacıyla kullanılır. Geniş renk yelpazesi il oldukça dekoratif ve fonksiyoneldir.

Wall Guard Systems are formed by fixing the top vinyl cover on the continuous aluminium retainer that has 25mm depth. The vinyl cover is anti-bacterial, impact-aqbsorber, unscratchable and fireproof. An impact-absorber rubber insert places between aluminium retainer and top vinyl cover, too. The system has its own specific ending caps; they can be chosen as in the same color or as in different colors in accordance with the decoration. The system is easy to install. The aluminium retainer is fixed on the wall surface at 50-60cm intervals. After fixing ending caps, the vinyl cover gets its place on top. They are generally used to protect the column ans wall surfaces against the impact of desks at shoos, tables at offices and streschers and wheelchairs at hospitals. The system is pretty decorative thaks to its wide color range.





KAFES GROUP
Ostim Osb Mh. 1568 Cd. No:51
06374 Yenimahalle/Ankara/Turkey
Tel.:+90 (0) 535 248 97 85
WEB.: www.kafesgroup.com
EMAIL.: info@kafesgroup.com

KAFES GROUP PROFILE SYSTEMS

180mm Elips Duvar Koruma Sistemi / 180mm Ellipse Wall Guard Systems



Duvar Koruma Sistemi 25mm derinliğinde 100mm, 150mm ve 200mm genişliğinde 3 farklı model olarak üretilmektedir. Sürekli alüminyum alt konstrüksiyon üzerine üst vinil kapağı takılarak oluşturulur. Vinil kapağı antibakteriyel, darbe emici, çizilmez ve yangın yürütmez özelliktedir. Alt alüminyum profil ile üst vinil kılıf arasındaki darbe emici fitil bulunmaktadır. Sistemin kendine has bitim aparatları mevcuttur. Dekorasyona uygun olarak aynı renkte veya farklı renklerde bitim aparatları seçimi yapılabilir. Uygulaması oldukça kolaydır. Alüminyum alt konstrüksiyon profilli duvar yüzeyine 50-60 cm arakıklarla sabitlenir. Bitim aparatları takıldıktan sonra üst vinil kılıfı takılır. Genellikle hastanelerde sedye ve tekerlekli sandalyelerin duvar yüzeylerine çarpmalarına karşı, okullarda ve ofislerde masa-sanlaşıyelerin duvar yüzeylerine çarpmalarından oluşabilecek hasarları engellemek amacıyla kullanılır. Geniş renk yelpazesi il oldukça dekoratif ve fonksiyoneldir.

Wall Guard Systems are formed by fixing the top vinyl cover on the continuous aluminium retainer that has 25mm depth. The vinyl cover is anti-bacterial, impact-absorber, unscratchable and fireproof. An impact-absorber rubber insert places between aluminium retainer and top vinyl cover, too. The system has its own specific ending caps; they can be chosen as in the same color or as in different colors in accordance with the decoration. The system is easy to install. The aluminium retainer is fixed on the wall surface at 50-60cm intervals. After fixing ending caps, the vinyl cover gets its place on top. They are generally used to protect the column and wall surfaces against the impact of desks at schools, tables at offices and stretchers and wheelchairs at hospitals. The system is pretty decorative thanks to its wide color range.





KAFES GROUP
Ostim Osb Mh. 1568 Cd. No:51
06374 Yenimahalle/Ankara/Turkey
Tel.:+90 (0) 535 248 97 85
WEB.: www.kafesgroup.com
EMAIL.: info@kafesgroup.com

KAFES GROUP PROFILE SYSTEMS

El Tutamaklı Duvar Koruma Sistemi / Wall Guard Systems With Handrail

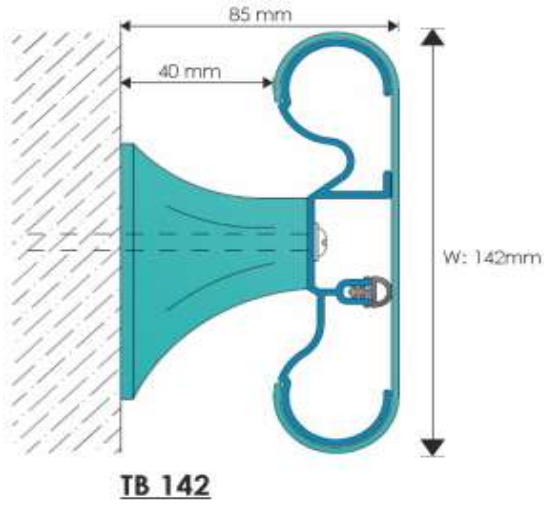

TB 142

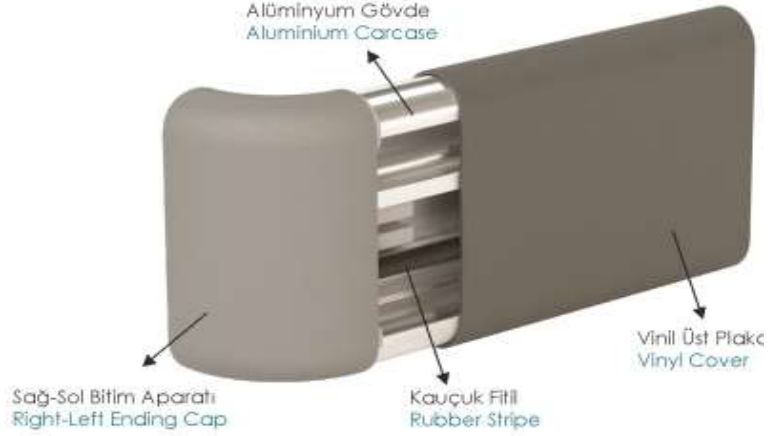

Sağ-Sol Bitim Aparatı
Right-Left Ending Cap



Dış Köşe
Dönüş Aparatı
Outside Cover



İç Köşe
Dönüş Aparatı
Inside Cover



Tutamak
Handrail

Tutamaklı duvar koruma sistemleri, 85mm derinliğinde sürekli alt konstrüksiyon üzerine; antibakteriyel, darbe emici, çizilmez ve yangın yürütmez özellikte vinil üst kılıfın geçirilmesi ile oluşur. Tutunma imkanı sağlayan yapısı sayesinde hastanelerde hastaların yürürken destek almasına yardımcı olur; aynı zamanda sedye ve tekerlekli sandalye çarpmalarına karşı kolon ve duvar yüzeylerini korur.

Handrail Wall Guard Systems are formed by fixing the anti-bacterial, impact-absorber, unscratchable and fireproof top vinyl cover on the continuous aluminium retainer that has 85mm depth. Thanks to their structure that provide grip, they both help patients to get support while walking on the hospital corridors and protect column and wall surfaces against stretcher and wheelchair impacts.





KAFES GROUP
Ostim Osb Mh. 1568 Cd. No:51
06374 Yenimahalle/Ankara/Turkey
Tel.:+90 (0) 535 248 97 85
WEB.: www.kafesgroup.com
EMAIL.: info@kafesgroup.com

KAFES GROUP PROFILE SYSTEMS

Peimum Tutamaklı Duvar Koruma Sistemi / Permium Wall Guard Systems With Handrail

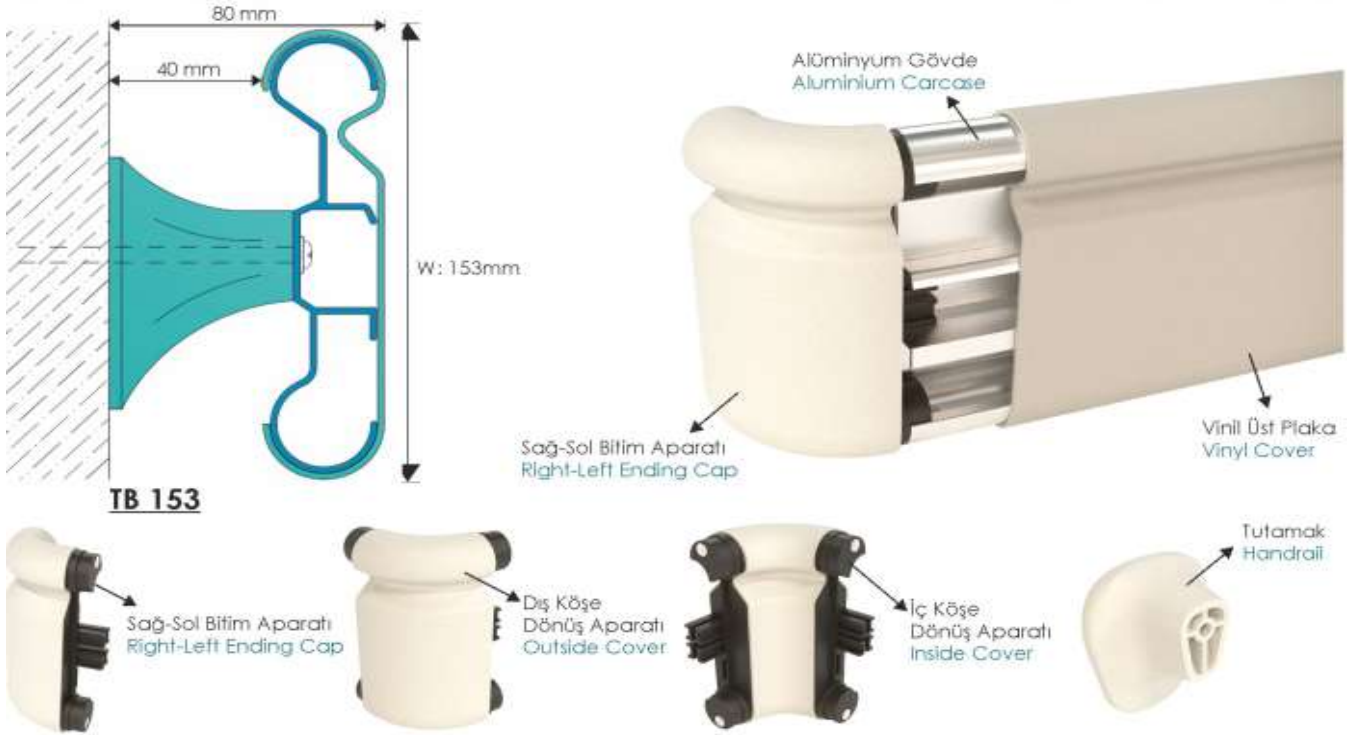

Tutamaklı duvar koruma sistemleri, 85mm derinliğinde sürekli alt konstrüksiyon üzerine; antibakteriyel, darbe emici, çizilmez ve yangın yürütmez özellikte vinil üst kılıfın geçirilmesi ile oluşur. Tutunma imkanı sağlayan yapısı sayesinde hastanelerde hastaların yürürken destek almasına yardımcı olur; aynı zamanda sedye ve tekerlekli sandalye çarpmalarına karşı kolon ve duvar yüzeylerini korur.

Handrail Wall Guard Systems are formed by fixing the anti-bacterial, impact-absorber, unscratchable and fireproof top vinyl cover on the continuous aluminium retainer that has 85mm depth. Thanks to their structure that provide grip, they both help patients to get support while walking on the hospital corridors and protect column and wall surfaces against stretcher and wheelchair impacts.





KAFES GROUP
Ostim Osb Mh. 1568 Cd. No:51
06374 Yenimahalle/Ankara/Turkey
Tel.:+90 (0) 535 248 97 85
WEB.: www.kafesgroup.com
EMAIL.: info@kafesgroup.com

KAFES GROUP PROFILE SYSTEMS

Köşe Koruma Sistemi / Corner Guard Systems



Köşe Koruma Sistemleri 90° köşe dönüşlerine uygun olarak tasarlanmıştır. Sürekli alüminyum alt konstrüksiyon üzerine; antibakteriyel, darbe emici, çizilmez ve yangın yürütmez özellikte vinil üst kılıfın geçirilmesi ile oluşur. Genellikle okullarda sıraların; ofislerde masa ve sandalyelerin; hastanelerde sedye ve tekerlekli sandalyelerin çarpmalarına karşı kolon ve duvar köşelerini korumak amacıyla kullanılır.

Corner Guard Profiles are designed for 90° wall corners. They are formed by fixing anti-bacterial, impact-absorber, unscratchable and fireproof top vinyl cover on the continuous aluminium retainer. They are mostly to protect the column and wall surfaces against the impact of desks at schools, table at offices and stretchers and wheelchairs hospitals.

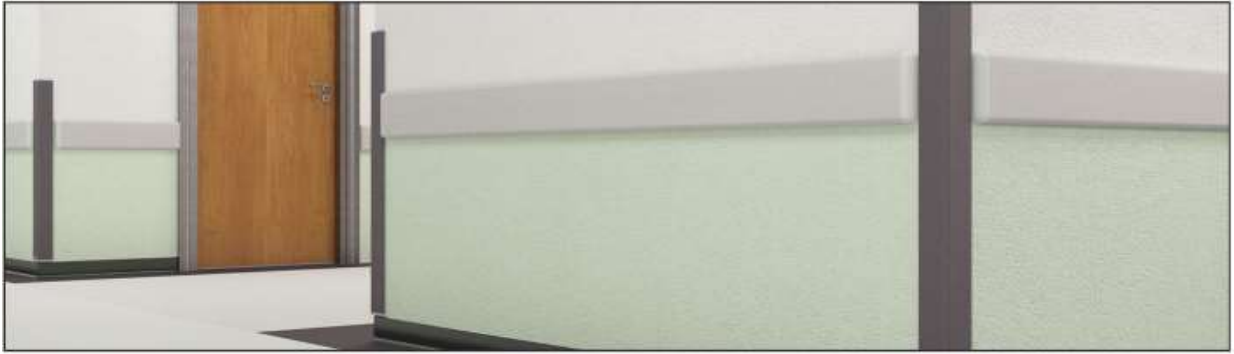



KAFES GROUP
Ostim Osb Mh. 1568 Cd. No:51
06374 Yenimahalle/Ankara/Turkey
Tel.:+90 (0) 535 248 97 85
WEB.: www.kafesgroup.com
EMAIL.: info@kafesgroup.com

KAFES GROUP PROFILE SYSTEMS

Otopark Duvar ve Köşe Koruma Sistemi / Car Park Wall and Corner Guard Systems

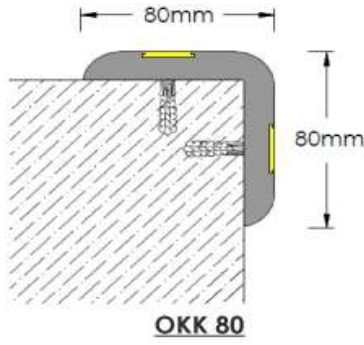
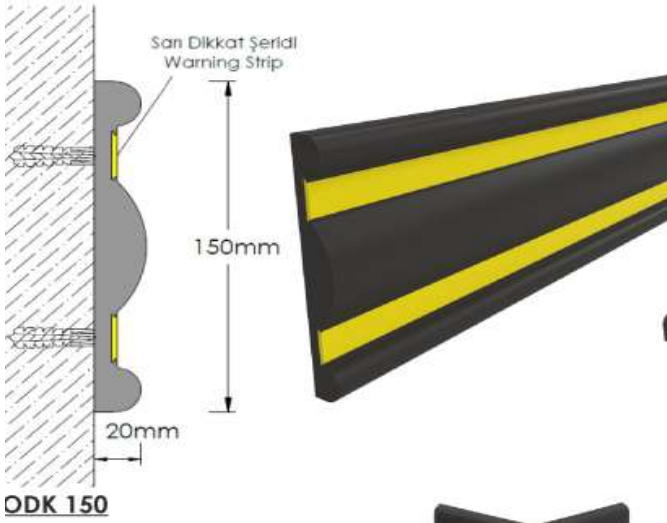

Kauçuk Otopark Köşe Koruma Sistemleri
Duvar ve Kolon köşelerini araç çarpmalarına karşı korur.
Yüzeyindeki fosfor bantlar sayesinde sürücülerin duvar ve
kolon köşelerini fark etmesini sağlar

Rubber Car Park Corner Guard Systems
Protect wall and column corners against vehicle
impacts, Thanks to the luminous strips on their
surface, they provide drivers to notice the corners
of walls and columns.

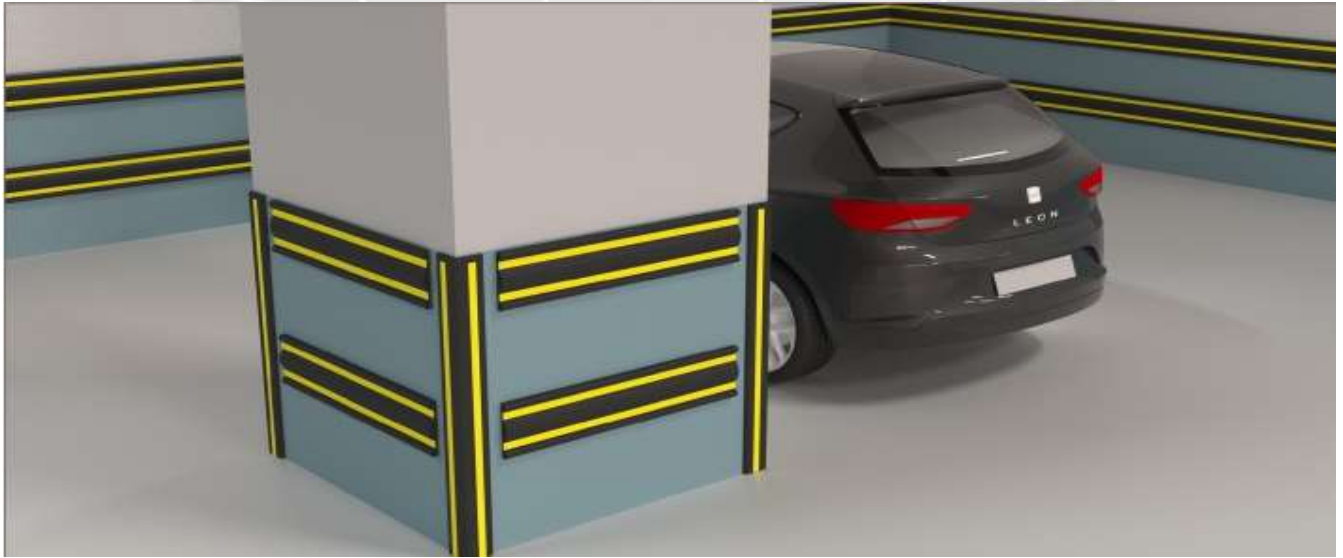



KAFES GROUP
Ostim Osb Mh. 1568 Cd. No:51
06374 Yenimahalle/Ankara/Turkey
Tel.:+90 (0) 535 248 97 85
WEB.: www.kafesgroup.com
EMAIL.: info@kafesgroup.com

KAFES GROUP PROFILE SYSTEMS

Alçıpan Fuga Profilleri / Drywall Profiles



Kod Code	Ölçüleri Dimensions	Materyal Material	Boy Length	Renk Color
AF 10	10mm x 12mm	Aluminium	3,00 m	Elektrostatik Toz Boya Electrostatic Powder Paint
AF 15	15mm x 12mm	Aluminium	3,00 m	
AF 20	29,5mm x 13mm	Aluminium	3,00 m	
AF 21	20mm x 12mm	Aluminium	3,00 m	
AF 25	23mm x 40mm	Aluminium	3,00 m	
AF 75	75mm x 12mm	Aluminium	3,00 m	

Kullanım Alanları : Asma tavan duvar birleşimlerinde veya duvar ve duvar birleşimlerinde çatlakların engellenmesi için kullanılır. Seramik kaplı duvar uygulamalarında da kesilen seramiklerin fuga içerisinde gizlenmesi sağlanarak dekoratif bir görüntü oluşturur.

Usage Areas : These profiles are used at the conjunction points of suspended ceiling to wall in order to prevent cracks. Also a decorative appearance is formed at the ceramic covered implementations by making ceramics hidden within the fuga profiles.

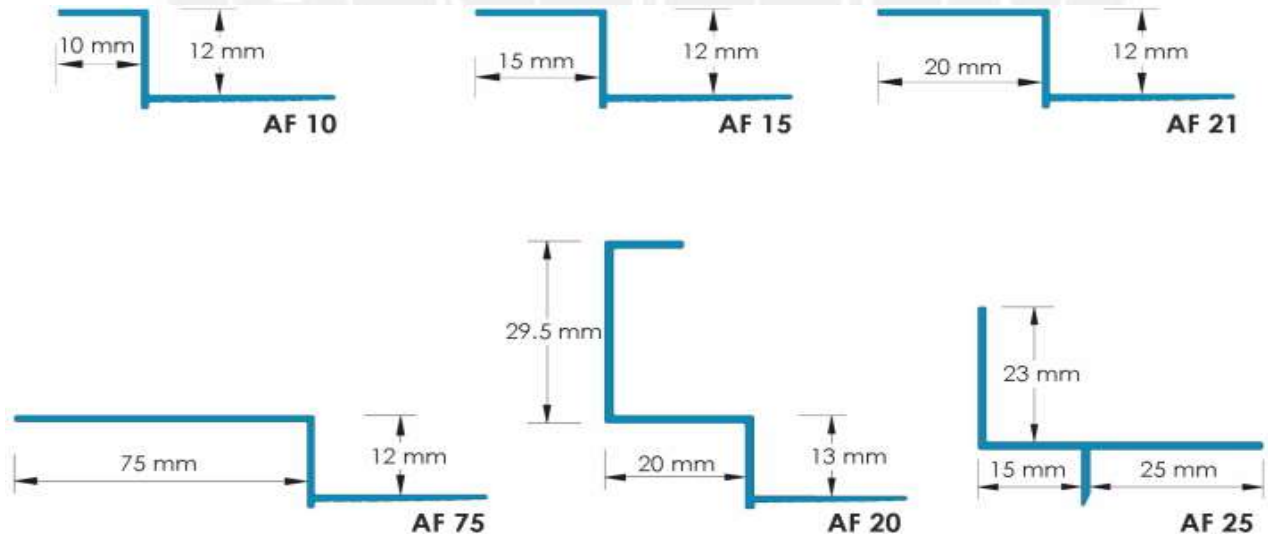

Not: AF 20 ve AF 25 Alçıpan Fuga Profillerimiz Tavan U Profili İşlevi Gördüğü için ayrıca Tavan U Profili Kullanımına Gerek Kalmaz.

NOTE: Since Our AF 20 and AF25 Coded Drywall Junction Profiles function as Ceiling "U" Profile, there is no need to use "U" Profile again.



KAFES GROUP
Ostim Osb Mh. 1568 Cd. No:51
06374 Yenimahalle/Ankara/Turkey
Tel.:+90 (0) 535 248 97 85
WEB.: www.kafesgroup.com
EMAIL.: info@kafesgroup.com

KAFES GROUP PROFILE SYSTEMS

Yalıtım Baskı Profilleri / Insulation Fixing Profiles

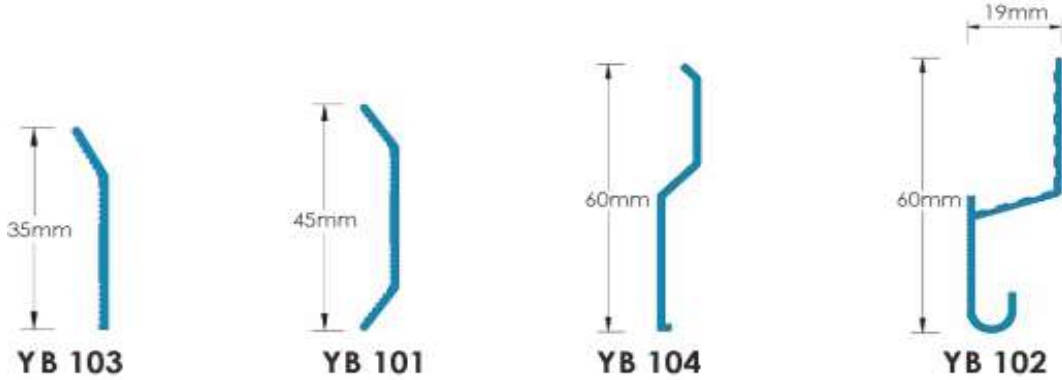

Kullanım Alanları : Membran uygulamalarında devara veya parapete dönülerek bitirilen uçları yalıtım baskı profilleri ile sabitlenerek membranın yerinden düşmesini engeller. Üst kısmına UV Dayanımlı mastik uygulaması tavsiye edilir. İstenirse Elektrostatik Toz Boya ile istenilen renge boyanabilir.

Usage Areas : Insulation press profiles are used in order fix membrane to wall at membrane implementations and it is provided that membrane does not fall. Using UV-resitant meastic is recommended on the top part. The profiles can be dyed by elctrostatic powder paint upon your request.

Kod Code	Materyal Material	Genişlik Width	Boy Lenght	Renk Color
YB 101	Alu	45 mm	3,00 m	
YB 102	Alu	60 mm	3,00 m	Naturel
YB 103	Alu	35 mm	3,00 m	Natural
YB 104	Alu	60 mm	3,00 m	



İzolasyon Askı Pimi (OPİM) / Insulation Hanger Pins

Kullanım Alanı : Bir yüzü yapışkanlı diğer yüzü çivilidir. Drenaj levhası, XPS veya EPS sabitlemede, ayrıca havalandırma sektöründe, cam yünü ve taş yünü levha şiltelerinin sabitlemesinde kullanılır.

Usage Areas : One side is adhesive and the other side has a screw. There are different aims of usage such fixing drainage boards, EXP or ESP, Moreover, they are used for fixing rock wools and fibreglasses in ventilation industry.

Kod Code	Uzunluk Lenght	Paketleme Packing
AP 040	40 mm	500 Adet / pcs
AP 060	60 mm	500 Adet / pcs
AP 080	80 mm	500 Adet / pcs
AP 100	100 mm	500 Adet / pcs
AP 120	120 mm	500 Adet / pcs





KAFES GROUP
Ostim Osb Mh. 1568 Cd. No:51
06374 Yenimahalle/Ankara/Turkey
Tel.:+90 (0) 535 248 97 85
WEB.: www.kafesgroup.com
EMAIL.: info@kafesgroup.com

KAFES GROUP PROFILE SYSTEMS

Kaba Sıva Köşe Profilleri / Rough Cast Corner Profiles

Kod Code	Materyal Material	Genişlik Width	Boy Lenght	Paketleme Packing
KP KS	GLY - ALU	30 mm	2,70 m	67,5 m

Kullanım Alanları : Makineli ve el ile yapılan sıva uygulamalarında köşe yüzeyin sıvayı iyi tutabilmesi için kullanılır. Köşelere yaklaşık 80 cm aralıklarla konulan yapııştırma harcı ile sabitlenir. Köşelerde Ano Çitası işlevi görür.

Usage Area : These profiles aim is to keep the plaster attached to the corner during the plaster implementations by hand or machine. They are fixed adhesive mortar that are placed in every 80 cm. They act as a gouge profile at the corners.

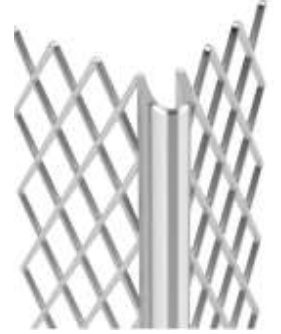

Alüminyum ve Galvaniz Köşe Profilleri / Aluminium and Galvanized Corner Profiles

Kod Code	Açı Angle	Materyal Material	Genişlik Width	Boy Lenght	Paketleme Packing
KP ALU	90°	ALU	Naturel	2,70 m	135 m
KP ALU 135°	135°	ALU	Natural	2,70 m	135 m
KP GLY	90°	GLY - ALU	Naturel	2,70 m	135 m
KP GLY 135°	135°	GLY - ALU	Natural	2,70 m	135 m

Kullanım Alanları : Dış ve iç cephelerde köşelerin düzgün oluşmasını sağlar. Darbelere karşı korur. 90° ve 135° olarak iki farklı açıda üretilir.

Usage Area : Corner Profiles help to form internal and external walls corners straight. Hold them intact. They are produced in 90° and 135° angles.



Fileli Alüminyum ve PVC Köşe Profilleri / Aluminium and PVC Corner Profiles With Mesh

Kod Code	Materyal Material	Renk Color	Boy Lenght	Paketleme Packing
KP ALU-FL	ALU	Beyaz - Mavi Turuncu	2,70 m	270 m
KP PVC-FL	PVC	White - Blue	2,70 m	125 m

Kullanım Alanları : Yalıtım levhaları üzerindeki tüm köşelerin düzgün olmasını sağlar ve darbelere karşı korur. Profilin üzerine yapıştırılmış file yüzeyden gelen file ile bağlantı oluşturup sistemin bütünlük kazanmasını sağlar.

Usage Area : Corner profiles with mesh ensure all of the corners on the insulating plate to comprise a straight form and protect them against strikes. The glued mesh over the profile forms a connection with the mesh coming from the surface and thus provides integrity.

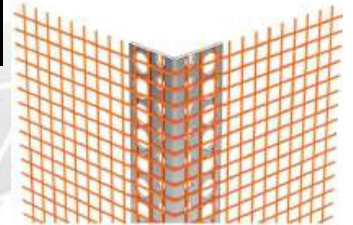

Fileli Alüminyum ve PVC Damlalık Profilleri / Aluminium and PVC Dripstone Profiles With Mesh

Kod Code	Materyal Material	Renk Color	Boy Lenght	Paketleme Packing
DP ALU-FL	ALU	Naturel	2,50 m	75 m
DP PVC-FL	PVC	Natural	2,50 m	75 m

Kullanım Alanları : Özellikle konsol çıkımlarında, balkon atlarında ve pencere üst köşelerde yüzeye gelen suları binadan uzaklaştırmak için kullanılır. Profilin üzerine yapıştırılmış file yüzeyden gelen file ile bağlantı oluşturup bütünlük kazanmasını sağlar.

Usage Area : Dripstone profiles aim is to remove the water coming from under the balconies or windows. The glued mesh over the profile forms a connection with the mesh coming from the surface and thus provides integrity.

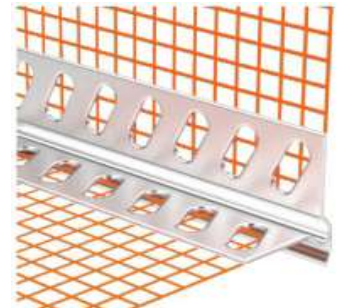



Denizlik Uzatma Profilleri / Windowsills Waterway Stretching Profiles

Kod Code	Genişlik Width	Renk Color	Boy Lenght	Paketleme Packing
DU ALU	80 mm	Beyaz White	3,00 m	75 m
DU PVC	58 mm/78 mm 98 mm/113 mm		3,00 m	75 m

Kullanım Alanları : Mevcut binalara mantolama yapıldığında denizlikler kısa kalır. Denizlik uzatma profili ile mevcut denizliklerinizi kırmadan çok daha ekonomik ve dekoratif olarak uzatabilirsiniz.

Usage Area : After insulation implementations, window sills fall short. In the situation, without destroying the existing windows aills one may make them longer by windows profiles.



PVC ve Alüminyum Fuga Profilleri / PVC and Aluminium Fuga Profiles

Kod Code	Genişlik Width	Derinlik Depth	Boy Lenght	Paketleme Packing
FP ALU	30 / 40 / 50	20 mm	3,00 m	75 m
FP PVC	30 / 40 / 50	15 mm	3,00 m	75 m
FP ALU-FL	30 / 40 / 50	20 mm	3,00 m	75 m
FP PVC-FL	30 / 40 / 50	15 mm	3,00 m	75 m

Kullanım Alanları : Dış ve iç cepheleri mimari tercihlere göre hareketlilik kazandırmak için kullanılır. Alüminyum ve PVC olarak üretilmektedir.

Usage Area : Fuga Profiles are used in order to provide movement interior and exterior facades for architectural reasons. Fuga profiles are made out of PVC and Aluminium.

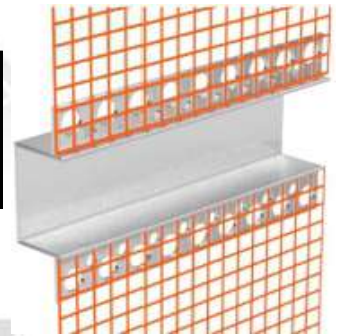

Aynalı Fuga Profili / Fuga Profile With Mirror

Kod Code	Genişlik Width	Derinlik Depth	Boy Lenght	Paketleme Packing
FP PVC-Tırnaklı	50	15 mm	3,00 m	75 m

Kullanım Alanları : Fuga Profil içerisindeki mevcut kanala yerleştirilen paslanmaz çelik mlevhalar sayesinde cephede parlak bir görüntü oluşmasını sağlar. Mimari tercihlere göre farklı renklerde ve ölçülerde üretilebilir.

Usage Area : A shiny view is provided on the facade thanks to the stainless steel plates placed in current channels within joint profile. May be produces in different colors and dimensions according to architectural preferences.



Alüminyum Subasman (Başlangıç) Profilleri / Aluminium Sub-Basement Profiles

Kod Code	Materyal Material	Genişlik Width	Boy Lenght	Paketleme Packing
SP ALU	ALU	33/43/53 63/73/83 103/123/153	2,50 m	25 m

Kullanım Alanları : Gönyesinde ve terazisinde düzgün bir başlangıç yapılmasını sağlar. Kendinden damlalığı sayesinde yüzeydeki suları uzaklaştırır. Aynı zamanda darebelere karşı korur. Kullanılan ısı yalıtım levhasına göre farklı kalınlıklarda üretilmektedir.

Usage Area : Sub-Basement profiles provide a regular begening. Thaks to existing dripstone, sub-basement profile removes the water. At the some time, this profile protect against strikes. Profiles are produced in different thickness according to chosen heat insulating plate.





KAFES GROUP
Ostim Osb Mh. 1568 Cd. No:51
06374 Yenimahalle/Ankara/Turkey
Tel.:+90 (0) 535 248 97 85
WEB.: www.kafesgroup.com
EMAIL.: info@kafesgroup.com

KAFES GROUP PROFILE SYSTEMS

Ayarlanabilir Açılı Köşe Profilleri / Adjustable Plaster Corner Profiles

Kod Code	Materyal Material	Renk Color	Boy Lenght	Paketleme Packing
KP AA	PVC	Beyaz White	2,50 m	100 m
KP KEMER	PVC		2,50 m	250 m

Kullanım Alanları : Köşelerin açısı her projede 90° veya 135° olmayabilir. Bu tip durumlar için ayarlanabilir açılı köşe profilleri üretilmiştir. Hiçbir alet edevat kullanmadan tamamen el yordamıyla istenilen açıya geçirelerek köşelerin düzgün oluşmasını sağlar ve darbelere karşı korur.

Usage Area : Corner's angle may not be always 90° or 135°. Adjustable Plaster Corner Profiles are produced for this kind of situations. One can make these profiles to form the required angle by hand without using any tools so that corners will be straight. These profiles hold corners intact.



Alçıpan Bitim Profilleri / Drywall Ending Profiles

Kod Code	Materyal Material	Sıva Yüksekliği Plaster Depth	Boy Lenght	Paketleme Packing
AB GLY	GLY	12 mm	3,00 m	150 m
AB ALU	ALU	12 mm	3,00 m	150 m

Kullanım Alanları : Alçıpan uygulamalarında başlangıç ve bitiş detaylarının kapanması için dizayn edilmiştir. 12mm kalınlığındaki alçıpan başlangıç ve bitişlerinin korunmasıyla uzun ömürlü ve estetik bir kullanım sağlar. Alüminyum ve Galvanizli Sac olarak üretilmektedir.

Usage Area : They are designed for drywall implementations in order to cover beginning and ending details. They provide a long-lasting usage decorative appearance by protecting the 12mm thick drywall finishing usage and beginning. They are made out of aluminium and galvanize.



Sıva Bitim Profili / Plaster Ending Profiles

Kod Code	Materyal Material	Sıva Yüksekliği Plaster Depth	Boy Lenght	Paketleme Packing
SB GLY	GLY	10 mm	3,00 m	150 m
SB ALU	ALU	10 mm	3,00 m	150 m

Kullanım Alanları : İç ve dış cephelerde sıvanın bittiği veya başka bir malzemenin başlayacağı (örneğin ahşap malzeme ile birleşim) noktalarında kullanılan bitiş profilidir. Alüminyum ve Galvanizli sac olarak üretilir.

Usage Area : . It is an ending profile that is used at the points where the plaster is ending at internal and external facades or where another material is coming (e.g. conjunction point with wooden material). They are made out of aluminium and galvanize.



Alüminyum Mastar Profilleri / Aluminium Plaster Rules Profiles

Kod Code	Materyal Material	Ölçüler Dimensions	Boy Lenght	Paketleme Packing
MST B	ALU	90x18x45	3,00 m	60 m
MST K	ALU	70x30x70	3,00 m	60 m
ANO	ALU	h=7 mm	3,00 m	90 m
GLY ANO	ALU	110x28x50	3,00 m	60 m

Kullanım Alanları : Alçı veya çimento sıvanın düzgün ve terazisinde yapılmasını sağlar. Birçok kez kullanma imkanı vardır.

Usage Area : Provide straightness for gypsum and cement plasters. These can be used more than once.

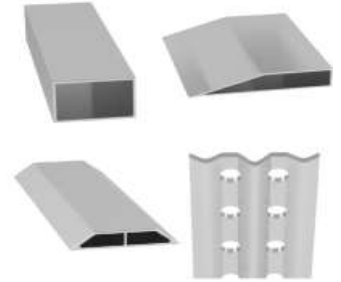



KAFES GROUP
Ostim Osb Mh. 1568 Cd. No:51
06374 Yenimahalle/Ankara/Turkey
Tel.:+90 (0) 535 248 97 85
WEB.: www.kafesgroup.com
EMAIL.: info@kafesgroup.com

KAFES GROUP PROFILE SYSTEMS

Sıva Dilatasyon Profili / Plaster Expansion Joint Profiles

Kod Code	Materyal Material	Sıva Yüksekliği Plaster Depth	Boy Length	Paketleme Packing
MS	GLY+PVC	12 mm	3,00 m	30 m

Kullanım Alanları : İç ve dış cephelerde Dilatasyon derzi noktalarında kullanılır. Kenarları Galvanizli çelik orta kısmı PVC den oluşmaktadır. Duvar yüzeyine dik yönde uygulanabilir.

Usage Area : Plaster Expansion joint profiles are used for internal and external facades where there is a joint gap, Edges of the profile are galvanize, the middle part is PVC. Implementation is done vertically.



Fileli Dilatasyon Profili / Expansion Joint Profiles With Mesh

Kod Code	Genişlik Width	Renk Color	Boy Length	Paketleme Packing
DA 1000-FL	50/100 mm	Gri / Grey	2,50 m	100 m

Kullanım Alanları : Isı yalıtım konulduktan sonra sıva aşamasında uygulanır. Aradaki TPE kauçuk bantı ile su yalıtımı sağlar. Her kalınlıktaki ısı yalıtım levhaları için kullanılabilir. Üzerindeki file ile sistem bütünlüğü sağlanır.

Usage Area : Having the heat insulation plate, expansion joint profiles with mesh are implemented during the plaster implementation. TPE Rubber insert provides Waterproofing. These profiles can be implemented for every heat insulation plate thickness. Systems integrity is provided by the mesh.



Sıva Filesi / Fiber Glass Mesh

Kod Code	Materyal Material	Renk Color	Ağırlık Weight	Paketleme Packing
SF 160	Cam Elyaf Glass fiber	Turuncu/Orange	160 g/m ²	50 m ²
SF 75		Beyaz/White	75 g/m ²	50 m ²
SF 56		Beyaz/White	56 g/m ²	100 m ²

Kullanım Alanları : Sıva fileleri cam ipliğinden dokunmuş çimento ve alçı sıva donatıdır. Sıva çatlaklarını önlemek için kullanılır. Farklı gramajlardaki farklı ölçülerde kesilmiş ürünlerimizle mermer ve mozaik sektörünün ihtiyacını karşılamaktayız.

Usage Area : Fiberglass meshes are the products made out of spun glass for cement and gypsum plaster usage. We provide marble and mosaic sector with fiberglass meshes arranged in different basis weight and different dimensions.



Mantolama Dübelleri / Insulation Plugs

Kod Code	Materyal Material	Renk Color	Boy Length	Paketleme Packing
MD	PVC	Siyah / Black	10 - 12	500 adet / pcs
	Çelik Çivili PVC/Steel Nail		14 - 16	

Kullanım Alanları : Mantolama uygulamalarında ısı yalıtım levhalarının duvara sabitlenmesi için kullanılır. Isı yalıtım levhası kalınlıklarına göre farklı uzunluklarda PVC ve çelik çivili olarak dübelllerimiz bulunmaktadır.

Usage Area : Insulation Plugs are used to fix heat insulation plates to walls at the insulation implementations. We have PVC plugs and plugs with stainless steel in different lengths according to the thickness of heat insulation plates.

